

---

PowerINSPECT 2016

# What's New



## **PowerINSPECT**

Copyright © 1993-2015 Delcam Ltd. All rights reserved.

Delcam Ltd has no control over the use made of the software described in this manual and cannot accept responsibility for any loss or damage howsoever caused as a result of using the software. Users are advised that all the results from the software should be checked by a competent person, in accordance with good quality control procedures.

The functionality and user interface in this manual is subject to change without notice in future revisions of the software.

The software described in this manual is furnished under licence agreement and may be used or copied solely in accordance with the terms of such licence.

Delcam Ltd grants permission for licensed users to print copies of this manual or portions of this manual for personal use only. Schools, colleges and universities that are licensed to use the software may make copies of this manual or portions of this manual for students currently registered for classes where the software is used.

### **Acknowledgements**

This documentation references a number of registered trademarks and these are the property of their respective owners. For example, Microsoft and Windows are either registered trademarks or trademarks of Microsoft Corporation in the United States.

# Contents

<b>New features</b>	<b>1</b>
<b>Working with CAD models</b>	<b>3</b>
Loading CAD models.....	4
Highlighting objects in CAD models.....	5
Identifying CAD objects by type.....	6
<b>Specifying nominals</b>	<b>8</b>
<b>Selecting ellipses</b>	<b>10</b>
<b>Report Note items</b>	<b>12</b>
Customizing Report Note items.....	14
<b>Section enhancements</b>	<b>16</b>
Creating guided section groups.....	17
Section shading mode.....	20
Section view.....	22
Section view toolbars.....	23
Displaying probed section points.....	25
Display settings for probed section points.....	27
<b>Editing probe databases</b>	<b>30</b>
<b>Label enhancements</b>	<b>31</b>
Displaying labels for GD&T items.....	32
Displaying grid lines on labels.....	34
Displaying form tolerance requirements in labels.....	35
<b>Point cloud enhancements</b>	<b>37</b>
Scanning point clouds.....	38
Resizing point clouds.....	40
Point Cloud Ellipse items.....	41
Viewing points and scanlines.....	44

<b>Displaying dual-column probe details</b>	<b>45</b>
<b>PowerINSPECT settings</b>	<b>47</b>
<b>Index</b>	<b>49</b>

# New features

PowerINSPECT 2016 contains the following new features and enhancements:

- **Working with CAD models** (see page 3) — Several improvements have been made to the way you load, manage, and view the details of models.
- **Specifying nominals** (see page 8) — You can now specify the nominal vector for Probed Parallel Plane, Plane: Parallel + Distance, Plane: Parallel Through Point, and Plane: Point + Vector items.
- **Selecting ellipses** (see page 10) — Ellipses are now selectable using the Wireframe Checker. This enables you to view their details, and to create items with the Geometry Explorer.
- **Report Note items** (see page 12) — The **Miscellaneous** toolbar now includes a Report Note item, which enables you to add customized text and images to the **Report** tab.
- **Section enhancements** (see page 16) — Several improvements have been made to the way you create and view sections.
- **Editing probe databases** (see page 30) — You can now edit the probe tool directly as you probe geometric items manually.
- **Label enhancements** (see page 31) — Improvements have been made to the formatting of labels, and you can now display labels for GD&T items.
- **Point cloud enhancements** (see page 37) — Several improvements have been made to PowerINSPECT's point cloud support.

- **Displaying dual-column probe details** (see page 45) — If you have the dual-column cost option, you can now switch the probe displayed during the measurement of items.
- **PowerINSPECT settings** (see page 47) — The **Options** dialog contains several new features, including, new colour options, and the ability to specify whether PowerINSPECT uses exact or rounded error values to determine if measured items are within tolerance.

# Working with CAD models

Several improvements have been made to the way you load, manage, and view the details of models:

- You can now load models by dragging and dropping files into the main graphics window (see page 4).
- A new button in the **CAD** tab enables you to highlight the selected entry in the CAD view (see page 5).
- New icons enable you to identify CAD objects by type (see page 6).

---

## Loading CAD models

You can now load models into PowerINSPECT by dragging and dropping files into the main graphics window.

To load a model into PowerINSPECT:

- 1 In Windows Explorer, locate the model file.
- 2 Left-click and hold the file to select it.



*To select multiple models, press and hold the **Ctrl** key while searching the files.*

- 3 Drag the file into the main PowerINSPECT graphics window.
- 4 When the cursor changes to , release the mouse button. If no documents are open, PowerINSPECT creates a document and adds the model to it.







# Highlighting objects in CAD models

Previously, when you selected a file, level, or object in the **CAD** tab, it was automatically highlighted in the CAD view to enable you to identify it. The colour of the highlighting was the same as that used for the Surface Selector. In PowerINSPECT 2016, a new **Highlight**

**CAD**  button enables you to choose whether the highlighting occurs when you select an entry.

To highlight objects in CAD models:

- 1 Select the **CAD** tab.
- 2 Select the **Highlight CAD**  button.
- 3 Select the **Summary/Detailed View**  button.
- 4 Click  to expand the **Parts**  and **User Levels**  entries, and then select a file, object, or level. The entry is highlighted in the CAD view using a lighter shade of its original colour, for example:

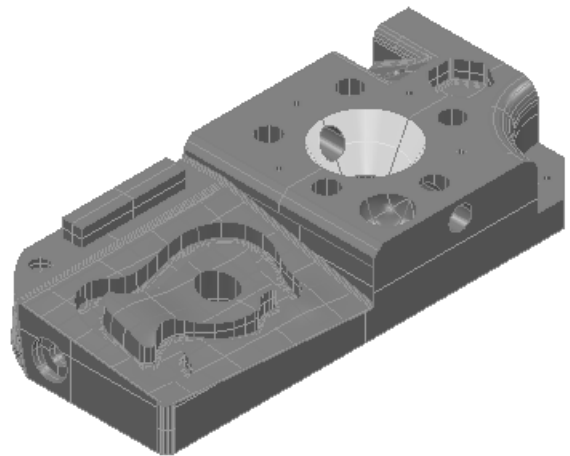
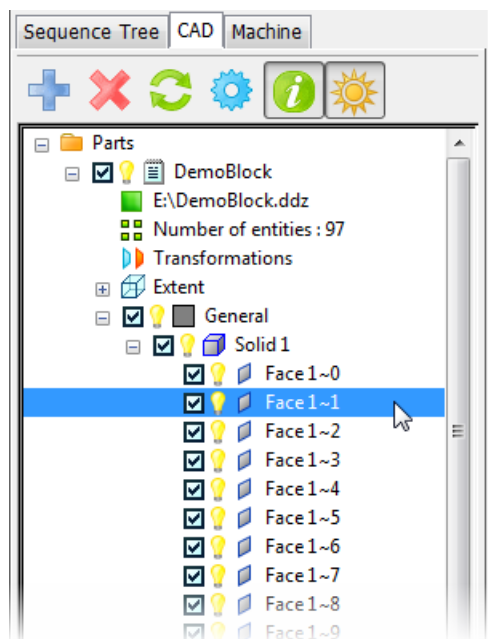













*If the original colour is white or a colour near white, the selected entry is highlighted in pink.*

---

## Identifying CAD objects by type

In PowerINSPECT 2016, the Detailed View of the **CAD** tab, the **CAD Object Visibility** dialog, and the **CAD Object Selection** dialog display an icon next to each constituent part of a model. This makes it easier to identify the type of objects you select and work with.

Icon	Object type
	Face
	Surface
	Wireframe
	Point
	Triangle Block
	GD&T Datum
	GD&T Tolerance
	Text
	Annotation Groups

Similarly, parent objects are now distinguished as Groups  or Solids , instead of being marked by folder  icons.

The following example shows how CAD objects were displayed in the **CAD** tab in the previous version of PowerINSPECT, and how the change has been implemented in the latest release:

### PowerINSPECT 2015 R2

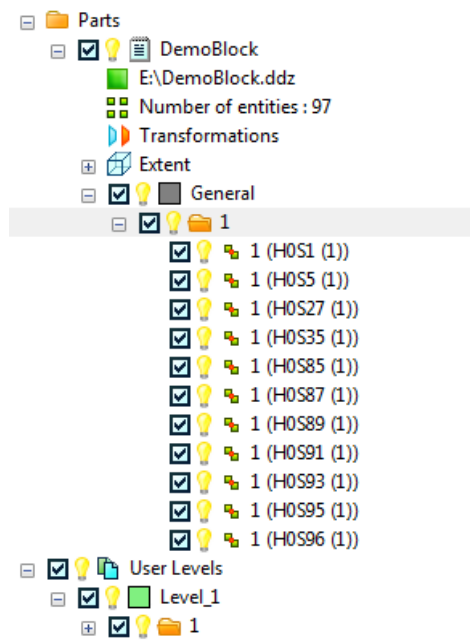

### PowerINSPECT 2016

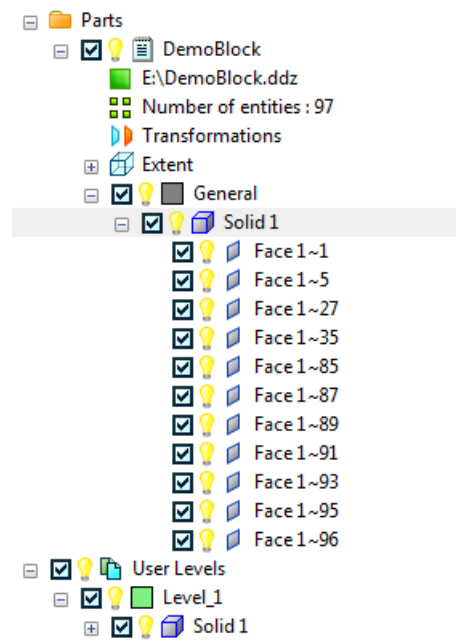



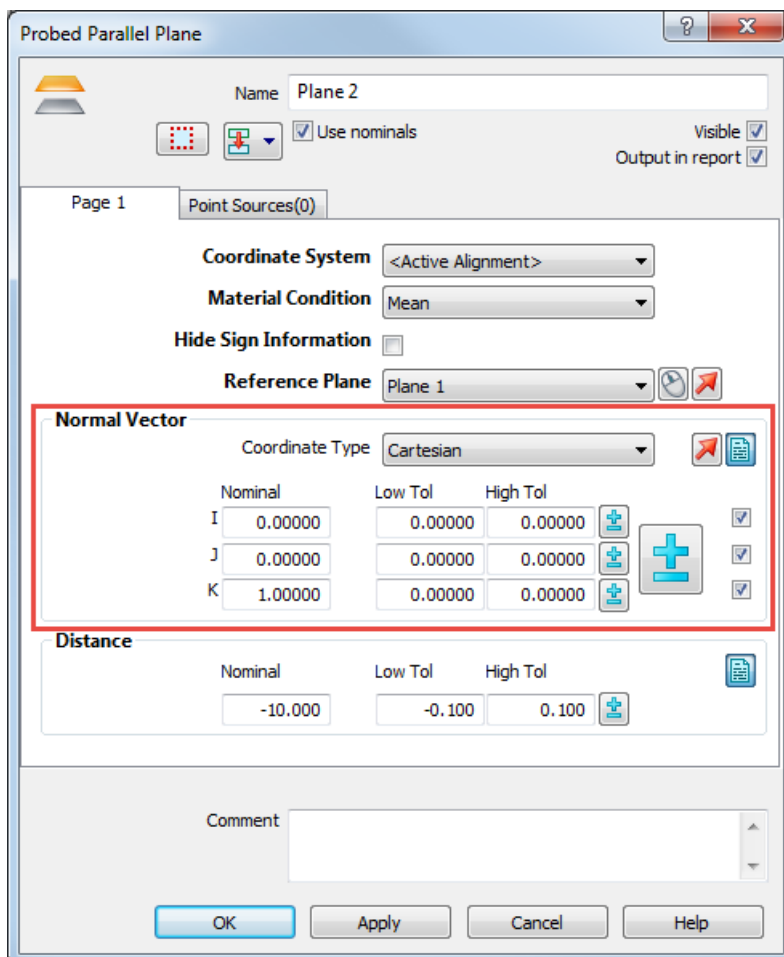

# Specifying nominals

A **Normal Vector** area has been added to the dialogs for Probed Parallel Plane, Plane: Parallel + Distance, Plane: Parallel Through Point, and Plane: Point + Vector items. Use it to specify the nominal vector of the planes' perpendiculars, as with other plane items.

For example, the **Normal Vector** area in the **Probed Parallel Plane** dialog:



To specify the nominals for one of these plane items:

- 1 In the inspection sequence, double-click the item's entry to display its definition dialog. Alternatively, right-click the entry, and then select **Modify Item** from the context menu.
- 2 Select the **Use nominals** check box.
- 3 In the **Normal vector** area, choose an entry from the **Coordinate type** list to specify the nominal format. Select:
  - **Cartesian** to enter the nominal in **IJK** format.
  - **Apparent angles** to enter the nominal in **ABC** degree format.
  - **Spherical** to enter the nominal as an azimuth (**A**) and elevation (**E**).
- 4 Enter the nominals of the item in the **Nominal** boxes. Alternatively, click , and then select **from CAD Entity** to load the nominals from the CAD model, or select **from Active Measure** to load the nominals from the current Measure.
- 5 Enter the tolerance range for the item in the **Low Tol** and **High Tol** boxes. Alternatively, click the  buttons to create a tolerance band to use across items.
- 6 To display the details of each nominal in the report, click , and then select the check box to the right of each nominal value.
- 7 To invert the direction of the vector, click .
- 8 Click **OK** to save your changes and close the dialog. The normal vector details are displayed in the **Info** tab, the **Report** tab, and in the inspection sequence when you click  next to the item's entry.

# Selecting ellipses

You can now select ellipse features from CAD models using the Wireframe Checker's Wireframe and Points picking modes. This enables you to use the **Geometry Explorer** tab to extract and display the nominals for the feature, and to create a geometric item in the inspection sequence.

To create an ellipse item using the Wireframe picking mode:

- 1 Display the model in the CAD view.
- 2 Select the **Geometry Explorer** tab.
- 3 In the **Mouse Context** toolbar, select the **Wireframe Checker**  button.
- 4 Right-click the CAD view, and then select **Wireframe** from the context menu.
- 5 Move the cursor over the model until the ellipse is highlighted yellow.
- 6 Click the wireframe to select the highlighted feature. The ellipse is displayed in red and its nominals are listed in the **Geometry Explorer** tab.

- 7 Check that the item displayed in the Item list is correct. When you select an ellipse, you can create a Probed Ellipse, Compound Ellipse, Point Cloud Ellipse, or Point Cloud Ellipse - Extracted from Clouds item.

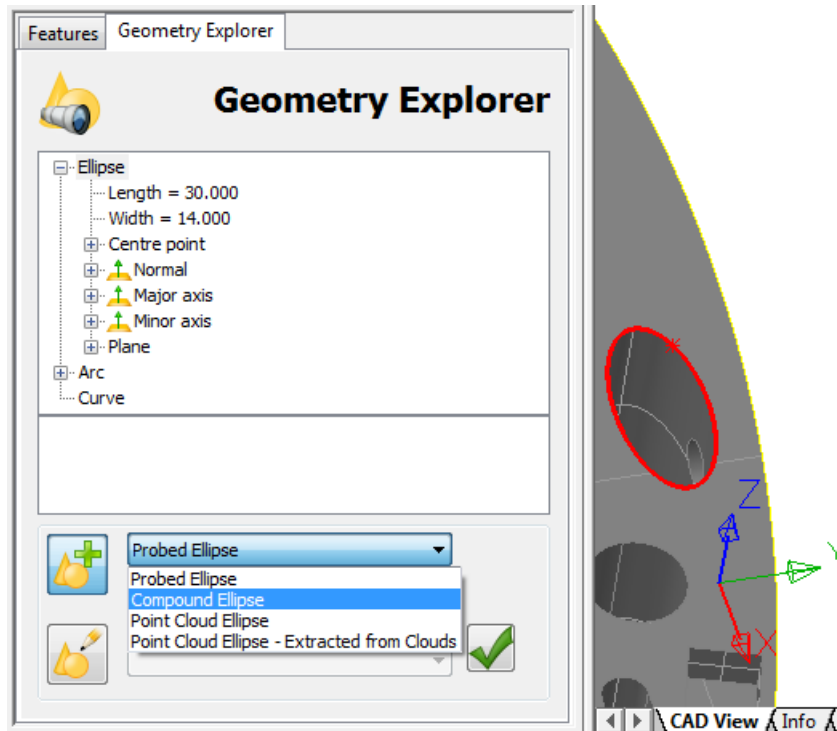

- 8 If you are creating a Probed Ellipse item, select a reference plane in the **Linked to** list.
- 9 Click . PowerINSPECT adds the new item to the inspection sequence.

# Report Note items



A new Report Note item has been added to the **Miscellaneous** toolbar. It works in a similar way to the Comment item, except that it is used to insert extra information and comments in the **Report** tab.

To create a Report Note item:

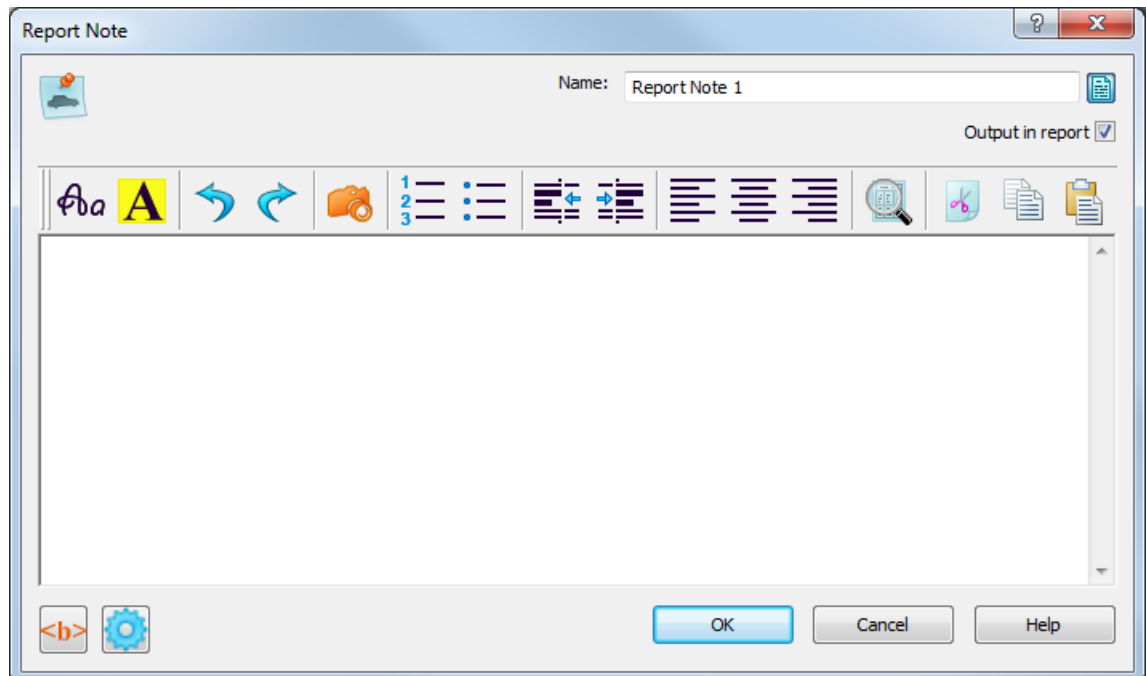
- 1 In the **Miscellaneous** toolbar, click the **Report Note**  button. The **Report Note** dialog is displayed.



- 2 Enter a **Name** for the item.

 *To hide the name in the report, click . Click the button again to reinstate the name.*

- 3 To include the item in the **Report** tab, select the **Output in report** check box.



- 4 In the entry area of the window, enter the text and images you want to display.
- 5 To format the text, use the buttons in the **Report Note** toolbar. Click:



to select a typeface for the current selection. The **Font** dialog is displayed.



to specify the background colour of the text.



to undo the last action.



to redo the last undo action.



to insert an image file. The **Picture** dialog is displayed.



to create a numbered paragraph.



to create a bulleted paragraph.



to outdent the selected paragraphs.



to indent the selected paragraphs.



to left-justify the selected paragraphs.



to centre the text of the selected paragraphs.



to right-justify the selected paragraphs.



to display the comment in the **Print Preview** window.





to remove the selected text or image from the window and copy it to the Windows clipboard.



to copy the selected text or image to the Windows clipboard.



to paste the contents of the Windows clipboard into the dialog.

- 6 To edit the HTML source, click . The button changes to .
- 7 By default, the content of the Report Note item is applied to all Measures. To customize the Report Note item for each Measure, and to specify the action of the item when it is played, click the **Settings**  button to open the **Report Note Settings** dialog (see page 14).
- 8 In the **Report Note** dialog, click **OK** to close the dialog and add the item to the inspection sequence. The contents of the note are displayed in the **Report** tab.

## Customizing Report Note items

Use the **Report Note Settings** dialog to specify how the Report Note item behaves, and to customize the note for each Measure in the inspection document.

To specify the settings for a Report Note item:

- 1 In the **Report Note** dialog, click the **Settings**  button. The **Report Note Settings** dialog is displayed.

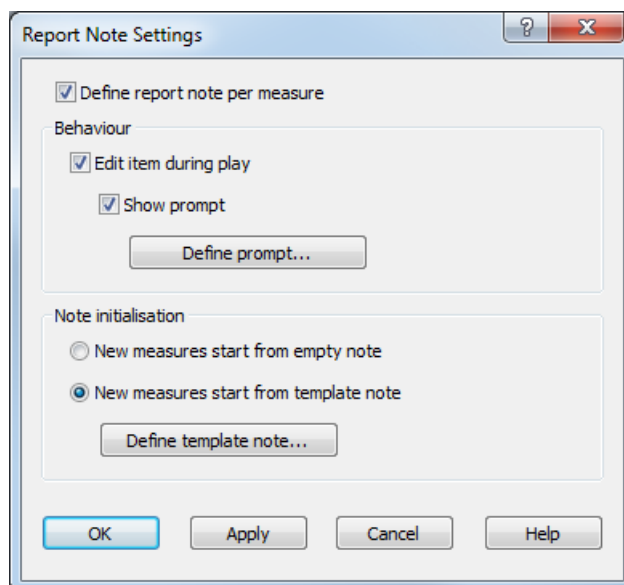

- 2 Select the **Define report note per measure** check box to enable the Report Note item to be customized for each Measure.



*If you deselect the check box for a customized Report Note item, it reverts to the contents you first specified.*

- 3 Choose the initial contents of the **Report Note** dialog in each new Measure. Select:
  - **New measures start from empty note** to leave the note empty.
  - **New measures start from template note** to display the original note. To change the content, click **Define Template Note** and edit the note.
- 4 To display the **Report Note** dialog and edit the note when you play the item, select the **Edit item during play** check box.  
Select the **Show prompt** check box to also display a prompt that cannot be edited. Click **Define Prompt** to specify the non-editable prompt.
- 5 Click **OK** to save your changes and close the dialog.

To customize the Report Note item in a Measure, select the Measure from the **Active Measures** list, and then edit the note.

# Section enhancements

Several changes have been made to how you create sections and view their measured results:

- The **Cut Plane** area of the **Section** dialog now includes a slider when you select a major plane. Use it to change the **Coordinate** of the point through which the major plane must pass, and see the cross-section update in real time in the CAD view.
- A Guided Section group has been created for measuring specific positions on a cross-section, enabling repeatability across Measures (see page 17).
- A new shading mode option enables you to control how models with sections are displayed in the CAD view (see page 20).
- To improve the display of sections, the Section Group view and its toolbars have been redesigned (see page 22).
- A new **Section Measurement Display** pull-out toolbar combines the deviation display options that previously were split across the CAD view and the Section Group view (see page 25).
- Previously, the display of probed points in section groups was controlled using the settings for surface inspection points. Now, a new tab in the **Filter Display** dialog enables you to control their display independently (see page 27).



---

## Creating guided section groups

You can now create Guided Section groups, which enable you to ensure that specific positions on the cross-section on a part are measured. They work in a similar way to Guided Surface Points groups. By specifying guided surface points, you can ensure repeatability across Measures, and use the points as constraining features in RPS alignments.

The buttons to create a Guided Section group and the existing Section group are available in a new **Section** toolbar.

To create a Guided Section group:

- 1 In the **Item** toolbar, select the **Section**  button. The **Section** pull-out toolbar is displayed.
- 2 Click the **Guided Section**  button. The **Section** dialog is displayed.
- 3 Use the **Cut Plane** area of the dialog to specify the location of the cross-section on the part, and use the other settings to specify naming rules for the probed points, and the tolerances and offsets for the section.
- 4 Click **OK** to close the dialog and add the group to the inspection sequence.
- 5 Play the group. PowerINSPECT displays a confirmation message.
- 6 Click **Yes**. PowerINSPECT switches to full-screen mode and displays the **Section Inspection** dialog.

- 7 Probe the points on the section you want to inspect.

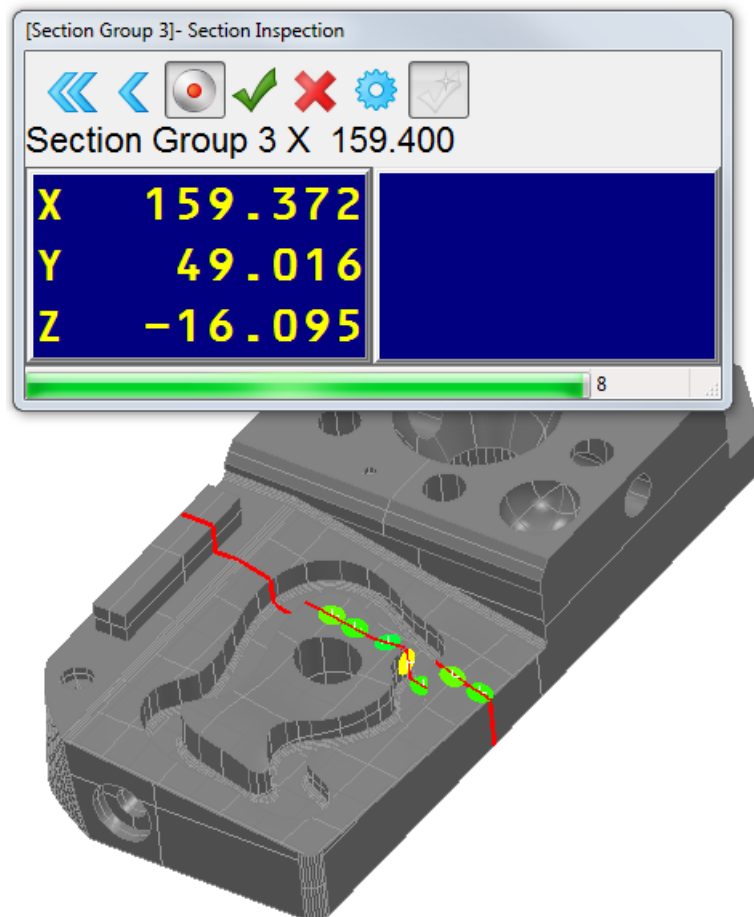

The left of the **Section Inspection** dialog displays the coordinate of the point on the section plane nearest the probed point. The progress bar at the bottom of the dialog shows how close the probed point is to the point on the section. When the probed point is in-tolerance, a coloured disc is displayed on the model, and the right of the dialog shows the distances between the probed point and the point on the section.

- 8 When you have specified the points, click  to close the dialog and return to the CAD view.
- 9 In the inspection sequence, right-click the group, and then select **Reset Item** from the context menu.
- 10 Play the group again. PowerINSPECT switches to full-screen mode and displays the **Guided Points** dialog. The positions of the points to be probed are shown as arrows on the model.

11 Probe the points indicated by the arrows.

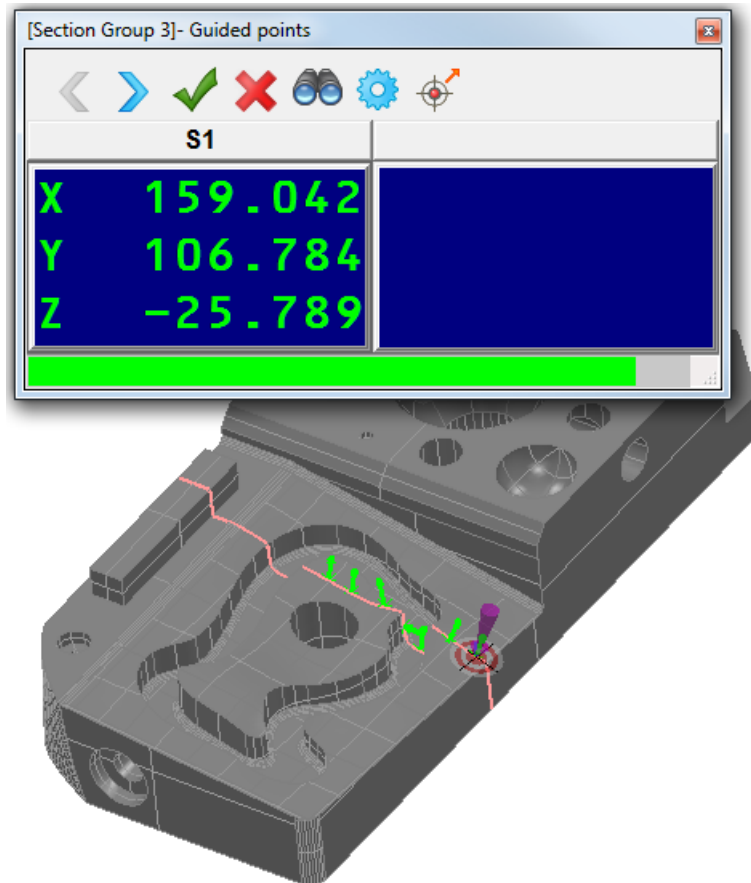

The left of the **Guided Points** dialog displays the coordinate of the current guided point. The progress bar at the bottom of the dialog shows how close the probed point is to the guided point. When the probed point is in-tolerance, a coloured disc is displayed on the model, and the right of the dialog shows the distances between the probed point and the guided point.



12 When you have finished probing, click  to close the dialog.

---

## Section shading mode

A new shading mode option has been added to the **CAD View** toolbar, which enables you to control how models with sections are displayed in the CAD view. Use it to help you identify selected section groups more easily.

To choose a shading mode:

- 1 In the inspection sequence, click  next to the section group you want to work with. The icon changes to .
- 2 Select the section group in the inspection sequence.
- 3 In the **CAD View** toolbar, click  below the **Section Shading**

**Mode**  button. The pull-out toolbar is displayed.

- 4 Click the shading mode you want to use. Click:

 to hide the part of the model that appears nearest.

For example:

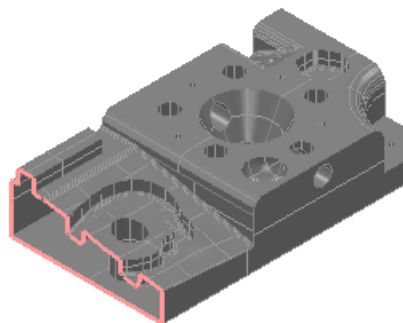





to display a semi-transparent representation of the part of the model that appears nearest.

For example:

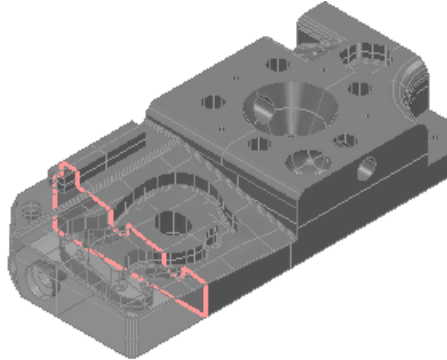

*This only works when you select the **Show Shaded and Wireframe** or **Shaded View** shading mode options for the model.*



to disable the shading mode.

## Section view

To improve the display of sections, the Section Group view has been redesigned. Previously, PowerINSPECT displayed a separate **Section Group** tab at the bottom of the main graphics window for each section group you created. In PowerINSPECT 2016, a single **Section View** tab is displayed, which shows the details of the currently selected section group in the inspection sequence.

When you have probed a section, you can use the updated **Section View** toolbars (see page 23) to choose how the deviations of measured points are displayed, and to manipulate the view.

In addition, you can now use the CAD View Report item to take a snapshot of the Section view.

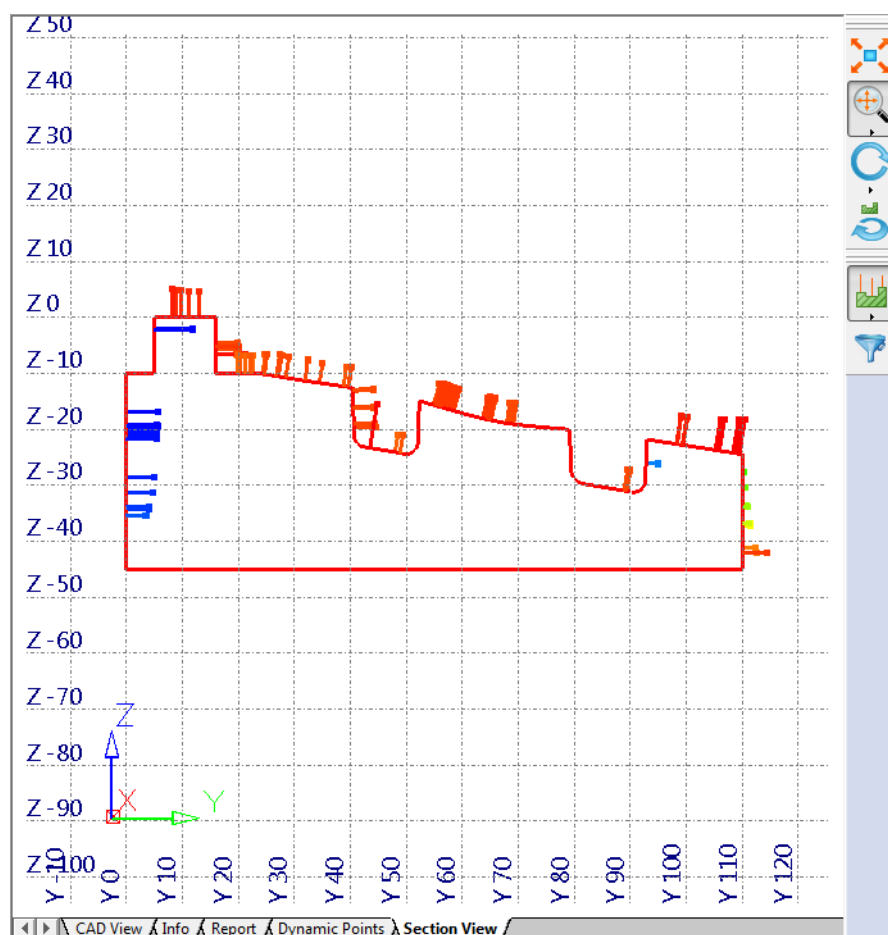













The background colour of the **Section View** tab is controlled using the settings for the **CAD View** tab. To change the colour, use the **Colours > General** page of the **Options** dialog (see page 47).

## Section view toolbars

The **Section View** toolbars are displayed when you select the **Section View** tab. They now include several new buttons, plus others that were previously available only in the **CAD View** and **View Options** toolbars in the **CAD View** tab. These additional buttons provide greater flexibility to manipulate the view of the cross-section through the part, and to control what information is displayed.

The buttons added to the **Section View** toolbars include:



Button	Action
	<p>Click  below the <b>View Mode</b> button to display the pull-out toolbar. Use the buttons in the toolbar to select the way in which the left mouse button manipulates the view.</p> <p> <i>The button is the same as that available in the <b>CAD View</b> toolbar, and replaces the previous <b>Zoom In</b> and <b>Zoom Out</b> buttons.</i></p>
	<p>Click  below the <b>Rotate View Around View Axis</b> button to display the pull-out toolbar.</p> <p>Click:</p> <p> to rotate the view around the normal of the section plane in a clockwise direction.</p> <p> to rotate the view around the normal of the section plane in a counter-clockwise direction.</p>
	<p>Click the <b>Switch Section Front/Back View</b> button to reverse the viewing direction of the section plane.</p>

Button	Action
	<p>Click  below the <b>Section Measurement Display</b> button (see page 25) to display the pull-out toolbar. Use the buttons in the toolbar to control the display of the deviation of probed section points.</p>
	<p>Click the <b>Filter Display</b> button to display the <b>Filter Display</b> dialog. Use the new <b>Section Inspection</b> tab (see page 27) in the dialog to specify which probed points are displayed.</p> <p> <i>The button is the same as that available in the <b>View Options</b> toolbar.</i></p>

## Displaying probed section points

A new **Section Measurement Display** button with pull-out toolbar has been added to the **View Options** toolbar in the CAD view, and to the **Section View Options** toolbar in the Section view. It combines the deviation display options for probed section points that previously were split across the **CAD View** and **Section Group** tabs.

To select the way in which probed section points are displayed:

- 1 In the inspection sequence, click  next to the measured section groups whose probed points you want to display. The icon changes to .
- 2 In the **View Options** toolbar (in the **CAD View** tab) or the **Section View Options** toolbar (in the **Section View** tab), click  below

the **Section Measurement Display**  button. The pull-out toolbar is displayed.

- 3 Choose the display mode you want to use. Click:



to display the deviation of each point as **Spot Confetti**.

For example, in the CAD view:

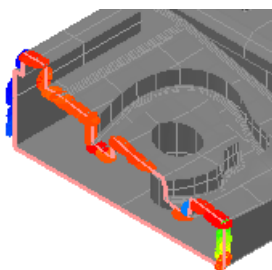

to display the deviation of each point as **Deviation Lines**.

For example, in the CAD view:

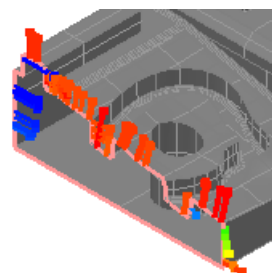



to display the deviation of each point as **Connected Deviation Lines**.

For example, in the CAD view:

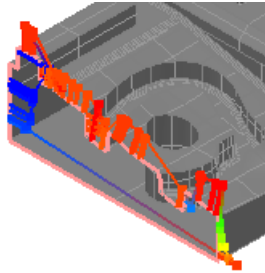

to display the deviation of each point as **Vector Lines**.

For example, in the CAD view:

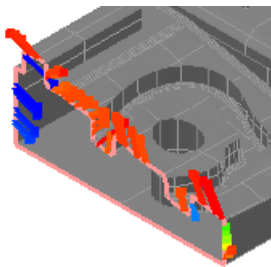

PowerINSPECT compares the measurement results to the CAD data and displays the deviation using colour:

- Green points are within tolerance.
- Red points are above the tolerance band.
- Blue points are below the tolerance band.

To hide the measured points, deselect the **Section Measurement Display** button.





*To show more details for each measurement, select the **Display section deviation text** check box in the **Section Inspection** tab of the **Filter Display** dialog (see page 27).*

# Display settings for probed section points

Previously, the settings in the **Surface Inspection** tab of the **Filter Display** dialog also controlled the display of probed section points. In PowerINSPECT 2016, the dialog has been extended to include a **Section Inspection** tab. Use the new tab to specify which measured points in section groups are displayed in the CAD view and in the Section view when you select a **Section Measurement Display** option.

To specify the settings for the display of probed section points:

- 1 In the inspection sequence, click  next to the measured section groups whose probed points you want to display. The icon changes to .
- 2 Select an option in the **Section Measurement Display** toolbar (see page 25).
- 3 In the **View Options** toolbar (in the **CAD View** tab), or the **Section View Options** toolbar (in the **Section View** tab), click the **Filter**

**Display**  button. The **Filter Display** dialog is displayed.

- 4 Select the **Section Inspection** tab.

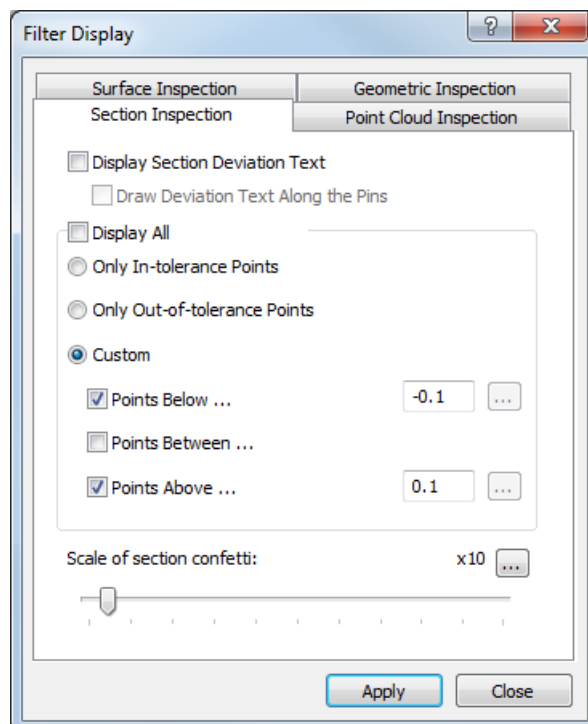

- 5 To show the calculated deviation of each probed point alongside its confetti, deviation line, or vector, select the **Display section deviation text** check box.

For example, in the CAD view:

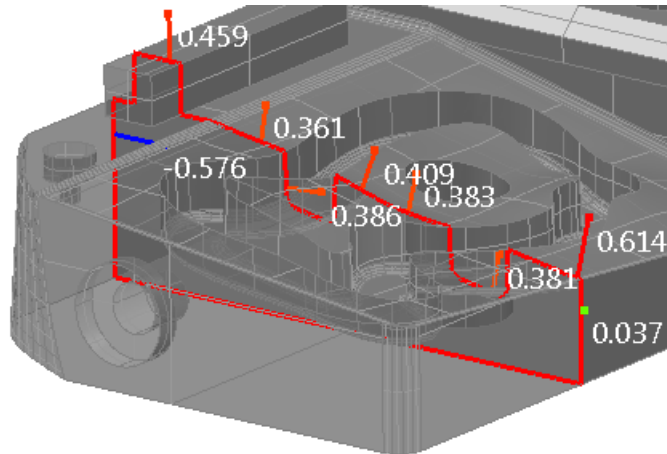

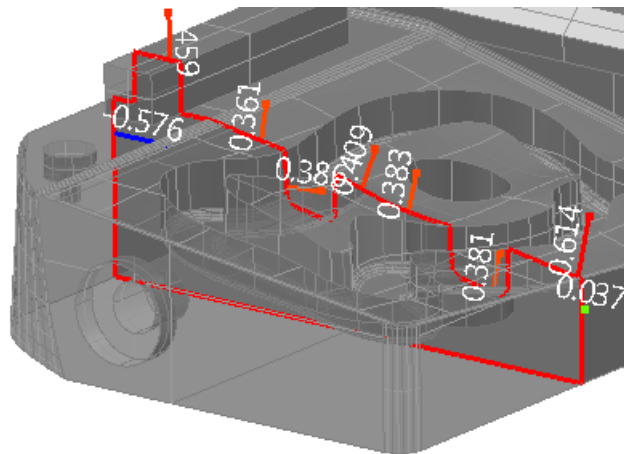

- 6 If the deviation of probed points are displayed as lines or vectors, select the **Draw deviation text along the pins** check box to display the calculated deviation along the length of the line or vector.

For example, in the CAD view:





- 7 By default, PowerINSPECT displays all probed points in the section group. To display only some of the points, deselect the **Display all** check box, and then select:
  - **Only in-tolerance points** to display only points that are within tolerance.
  - **Only out-of-tolerance points** to display only points that are out-of-tolerance.
  - **Custom** to specify the lower and upper tolerance limits of the points to be displayed. Select the **Points below** check box to display points below the specified lower tolerance limit; select the **Points above** check box to display points above the specified upper tolerance limit; select **Points between** to display points between the specified upper and lower tolerance limits.
- 8 To change the magnification of the deviation indicators, move the slider. To change the magnification limit, click , and then enter a new maximum value.

 *This has no effect if the deviation is displayed as **Spot Confetti**.*
- 9 Click **Apply** to save your changes and display them in the CAD view and in the Section view.
- 10 Click **Close** to close the dialog.

# Editing probe databases

A new **Edit Database**  button has been added to the **Feature Probing** dialog, which is displayed when measuring items. Use it to view and change the settings of the measuring device in the **Machine Configuration** dialog.

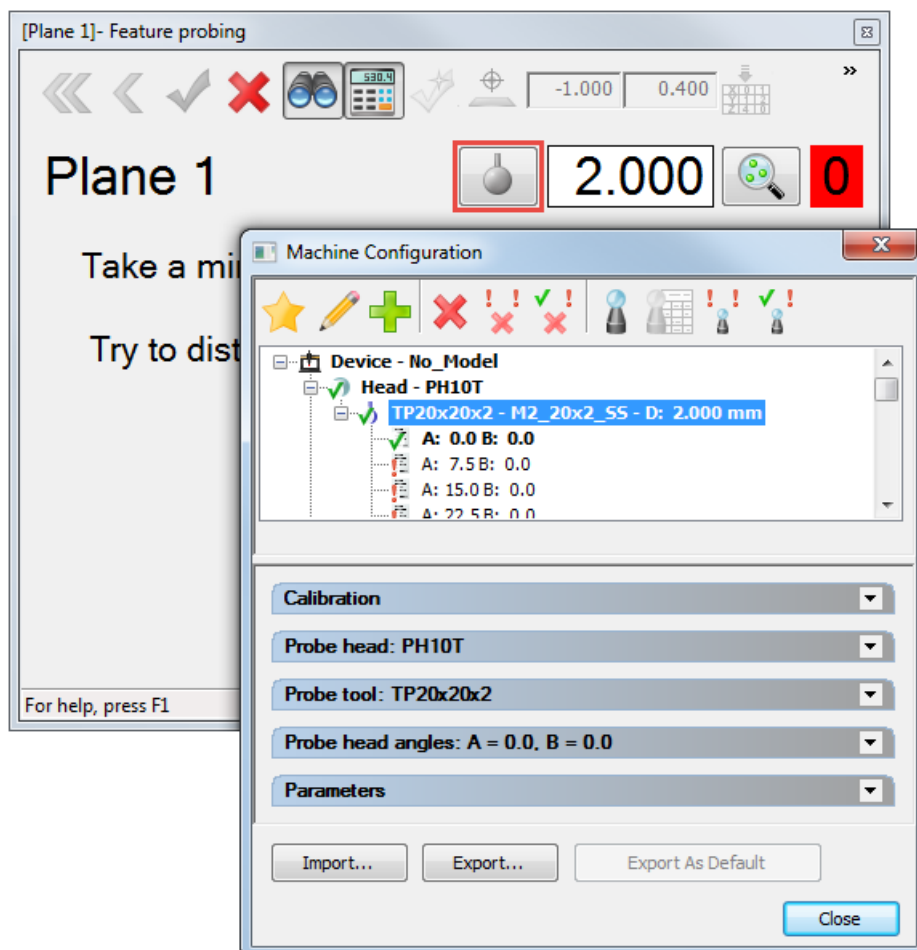

# Label enhancements

Several improvements have been made to PowerINSPECT's label feature:

- Labels can now be displayed in the CAD view for GD&T items (see page 32).
- The **Session Label Settings** dialog includes a new option that enables you to display grid lines on labels (see page 34).
- The form tolerance requirements for a Geometric item can now be displayed on the item's label (see page 35).

---

## Displaying labels for GD&T items

You can now display the details of GD&T items in the CAD view using labels. In addition, new options have been added to the **Session Label Settings** dialog to enable you to further customize what information is included in the label by default.

To display labels for GD&T items:

1 In the inspection sequence, click  next to the GD&T item entries for which you want to display a label. The icon changes to .

2 In the **View Options** toolbar, click  below the **Show/Hide**



**Labels** button. The pull-out toolbar is displayed.

3 Select a label mode. A label is displayed in the CAD view for each visible GD&T item.

4 In the **View Options** toolbar, click the **Show Global Label Settings**



button to specify label settings. The **Session Label Settings** dialog is displayed.

5 Select the **General** tab.

6 Select the settings you want to use. In the **Rows** area, select the:

- **Control frame** check box to display a summary of the tolerancing requirements for a GD&T item in a control frame at the top of the label. For GD&T Datum items, PowerINSPECT displays the **Datum feature symbol**.



*A control frame is not displayed in the label for a GD&T Linear Dimension item.*

- **GD&T status** check box to display the measurement status for a GD&T item.

- 7 Complete the dialog, and then click **OK** to save your changes and close the dialog.

In the CAD view, PowerINSPECT displays a label, and an arrow terminated by an asterisk marker. The arrow links the label to the feature on the model used to specify the GD&T item. If you specify more than one feature for a GD&T True Position item, the marker is displayed on the first specified feature.

The colour of the label's border indicates the result of the item:

- Green indicates the measurement is in-tolerance.
- Red indicates the measurement is out-of-tolerance.
- Gold indicates the measurement has not been calculated.
- Black indicates the item is unmeasured, for example, a GD&T Datum item.

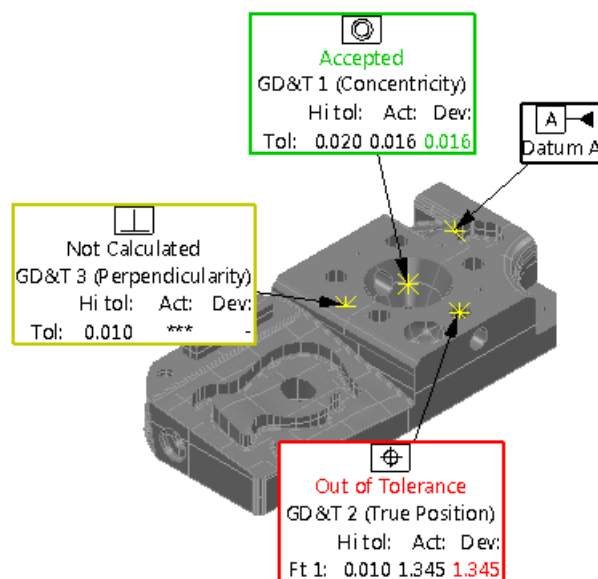

*To change the colour of the asterisk marker, use the **Colours > Entities** page of the **Options** dialog (see page 47).*

## Displaying grid lines on labels

You can now display grid lines on labels. This makes it easier to view the information shown in the labels in the CAD view, and in the report. For example:

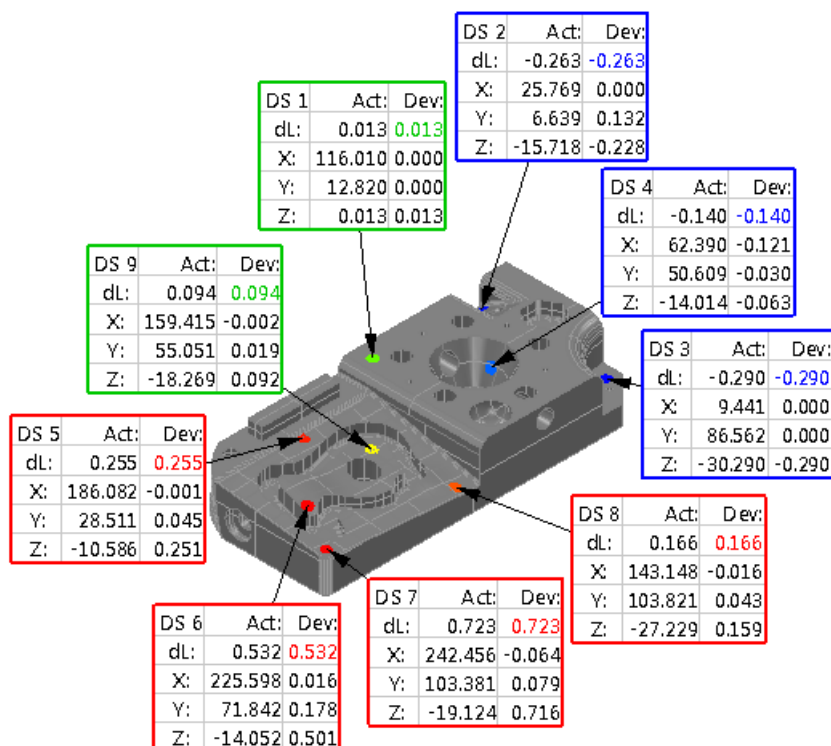

To display grid lines on labels:

- 1 Display the labels in the CAD view.
- 2 In the **View Options** toolbar, click the **Show Global Label Settings**  button. The **Session Label Settings** dialog is displayed.
- 3 Select the **General** tab.
- 4 In the **Appearance** area, select the **Display gridlines** check box.
- 5 Click **OK** to save your changes and close the dialog. The grid lines in the labels are displayed.





To change the grid line colour, use the **Colours > General** page of the **Options** dialog (see page 47).

---

## Displaying form tolerance requirements in labels

With the introduction of the **Control frame** option (see page 32) in the **Session Label Settings** dialog, you can now display a summary of the form tolerance requirements for a Geometric item at the top of its label. Form tolerances include, Circularity, Conicity, Cylindricity, Flatness, Profile, Sphericity, and Straightness.

To display a summary of the form tolerance requirements in the labels of Geometric items:

- 1 Display the labels in the CAD view.
- 2 In the **View Options** toolbar, click the **Show Global Label Settings**  button. The **Session Label Settings** dialog is displayed.
- 3 Select the **General** tab.
- 4 In the **Rows** area, select the:
  - a **Control frame** check box.
  - b **Geom tolerance** check box.
- 5 Click **OK** to save your changes and close the dialog.
- 6 In the CAD view, right-click the label for a Geometric item, and then select **Edit Item** from the context menu. The item's definition dialog is displayed.
- 7 Select the **Output in report** check box.
- 8 Click  next to the form tolerance property. The button changes to .

- Click **OK** to save your changes and close the dialog. PowerINSPECT summarizes the form tolerance requirements for the item in a control frame at the top of the item's label. For example:

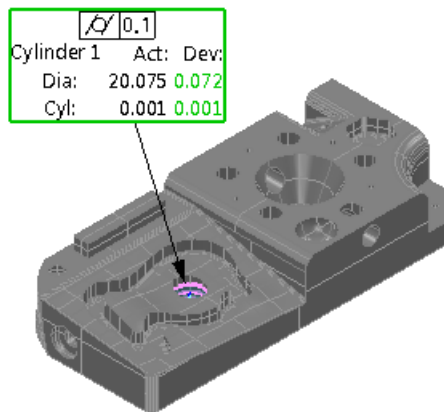

- Repeat steps 6 to 9 to continue displaying form tolerance requirements in the labels for other Geometric items.



# Point cloud enhancements

Several improvements have been made to PowerINSPECT's point cloud support:

- The **Import Points Wizard** now enables you to import point clouds from Triangle STL and DMT Triangle formats.
- The **Point Cloud Tool** dialog includes a new option that allows you to create multiple point cloud items during a single scanning session (see page 38).
- The **Point Cloud Acquisition Options** dialog includes a new parameter that enables you to further control the full-screen mode's zoom function during scanning (see page 40).
- The **Point Cloud Features** toolbar now includes a Point Cloud Ellipse item, which enables you to create and measure an ellipse using point cloud data (see page 41).
- The inspection sequence now displays the number of points and scanlines used to measure a Point Cloud Feature item (see page 44).



*Point clouds are available only as a cost option.*

## Scanning point clouds

Enhancements to the **Point Cloud Tool** dialog mean you can now save points in new point cloud items each time you pause and resume scanning. This allows you to create several point cloud items during one scanning session without having to leave the full-screen view.

To create multiple point cloud items during a single session:

- 1 Create a point cloud group.

- 2 Open the group, and then click the **Point Cloud**  button in the toolbar. The CAD view switches to full-screen mode and the **Point Cloud Tool** dialog is displayed.

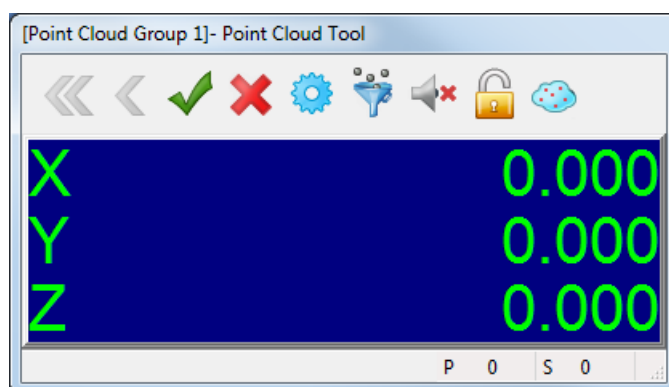

- 3 Use the buttons in the toolbar to specify the **Parameters**, **Acquisition 3D Filter**, **Laser Proximity Sound**, and **Lock View** settings.

- 4 Select the **Turn Committing On Pause**  button to create a new point cloud item each time you pause and resume scanning. The

button changes to .

 *To select the button by default, select the **Commit point clouds on pausing** check box in the **Full Screen Measurement** page of the **Options** dialog (see page 47).*

- 5 Hold the laser probe perpendicular to the feature, project the laser line onto the part, and then press the arm's trigger button.
- 6 Move the probe over the part to record points ensuring the laser line is broken by the feature.

- 7 When you have completed scanning the part, press the trigger button again. The scanned points are added to a point cloud item in the inspection sequence.



To delete the points in the last point cloud, click .

Alternatively, click  to delete all points taken.

- 8 Repeat steps 5 to 7 to create another point cloud item.

- 9 When you have finished, click  to save the points, close the dialog, and return to the CAD view.

---

## Resizing point clouds

A new **Automatic Zooming** option in the **Point Cloud Acquisition Options** dialog enables you to control which points are displayed in the full-screen view as you scan a part.

To specify the zoom parameters:

- 1 In the **Point Cloud Tool** dialog, click the **Parameters**  button. The **Point Cloud Acquisition Options** dialog is displayed.

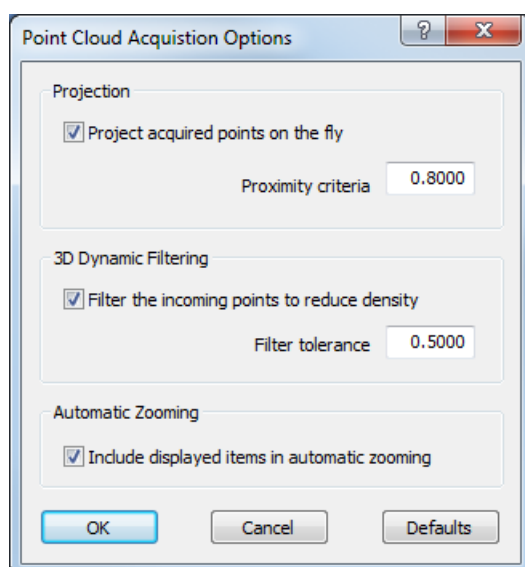

- 2 Specify the **Projection** and **3D Dynamic Filtering** parameters.
- 3 As you scan the part, the full-screen view automatically adjusts to display the acquired points. If you want the full-screen view to also display all visible point clouds, select the **Include displayed items in automatic zooming** check box.
- 4 Click **OK** to save your changes and close the dialog.

# Point Cloud Ellipse items

A new Point Cloud Ellipse item has been added to the **Point Cloud Features** toolbar. Use it to enable you to measure an ellipse within a point cloud.

To create a Point Cloud Ellipse item:

- 1 In the **Point Cloud Features** toolbar, click the **Point Cloud Ellipse**



button. The **Point Cloud Ellipse** dialog is displayed.

A screenshot of the 'Point Cloud Ellipse' dialog box. The dialog has a title bar with a question mark and a close button. Inside, there's a 'Name' field with 'Ellipse 1'. Below it are checkboxes for 'Use nominals', 'Visible', and 'Output in report'. There are tabs for 'Page 1', 'Page 2', and 'Point Sources(0)'. The 'Coordinate System' is set to '<Active Alignment>'. There are fields for 'Evaluate from nominal', 'Depth' (0.000), and 'Search Distance' (5.000). The 'Centre' section has a 'Coordinate Type' dropdown set to 'Cartesian' and a table for X, Y, and Z coordinates with nominal values (0.000 mm) and tolerance ranges (-0.100 to 0.100). Below are sections for 'Major Axis Length' and 'Minor Axis Length', each with nominal values (30.000 and 20.000) and tolerance ranges. At the bottom is a 'Comment' text area and buttons for 'OK', 'OK & Repeat', 'Cancel', and 'Help'.

- 2 Enter a **Name** for the item.
- 3 To display the item in the CAD view, select the **Visible** check box.
- 4 To include the item in the report, select the **Output in report** check box.
- 5 Select the **Coordinate system** relative to which the item's measurements are to be reported.

- 6 To compare the measurements to their nominal values:
  - a Select the **Use nominals** check box.
  - b In the **Centre** area, enter the nominal and tolerances for the position of the ellipse's centre.
  - c In the **Major axis length** area, enter the nominal length and tolerances of the ellipse's longest axis.
  - d In the **Minor axis length** area, enter the nominal length and tolerances of the ellipse's shortest axis.
  - e In the **Main axis** area, enter the nominal and tolerances for the orientation of the major axis.
  - f In the **Normal vector** area, enter the nominal vector and tolerances for the normal of the scanned surface.



*Unlike 2D features created using conventional probes, laser-scanned 2D features are not projected onto a reference plane. Instead, the reference plane is determined by the area around the feature; the **Normal vector** specifies the orientation of this plane.*



*Alternatively, click  and select **from CAD Entity** to load the nominals from the model, or select **from Active Measure** to load them from the current Measure.*

- 7 By default, PowerINSPECT searches the entire point cloud for the feature. To limit the search for the ellipse to the region around its nominal position:
  - a Select the **Evaluate from nominal** check box.
  - b Enter a **Depth** to specify the distance from the feature's plane at which scanlines are considered.
  - c Enter a **Search distance** to specify the maximum distance from the feature's nominal position within which you want PowerINSPECT to search.
- 8 In the **Profile** area, enter the **Maximum** distance from the nominal ellipse at which scanned points remain in-tolerance. If the deviation of a point exceeds this value, it is reported as out-of-tolerance.
- 9 To include any extra information about the item, enter a **Comment**.

- 10 To use the points from other items to measure this item, select the **Point Sources** tab, and then select the items that contain the points you want to use.
- 11 Click **OK** to close the dialog and create the item in the inspection sequence. The details of the feature are displayed in the **Info** tab, the **Report** tab, and in the inspection sequence when you click  next to the item's entry.

To detect the ellipse, you must pass the laser probe over the feature so that the scanlines cover the outline. The number of scanlines required depends on the size of the feature.



*You can create a Point Cloud Ellipse item using the Geometry Explorer when you select an ellipse feature from the CAD model (see page 10).*

---

## Viewing points and scanlines

The number of points and scanlines used to measure a Point Cloud Feature item is now displayed in the inspection sequence.

To view the details of a Point Cloud Feature item, click  next to the item's entry in the inspection sequence. For example:

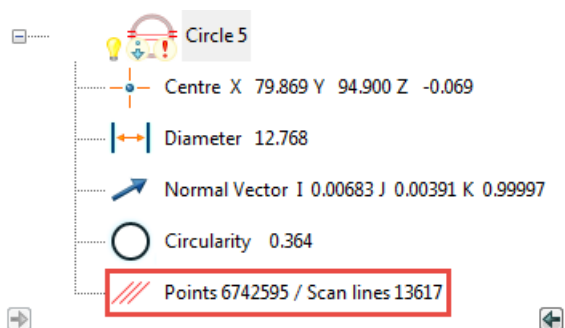



# Displaying dual-column probe details

The **Machine Configuration** dialog now enables you to switch columns when using a dual-column device. In addition, the **Status** display box and **Tracking Box** button have been added to the dialog, giving you the ability to see the connection status and probe position for the selected column.



*Dual-column is available only as a cost option.*

To view the column details during probing:

- 1 Play the inspection sequence. PowerINSPECT switches to full-screen mode and displays the **Feature Probing** dialog for the first item.

- 2 In the **Full Screen Options** toolbar, click the **Edit Database** button. The **Machine Configuration** dialog is displayed, for example:



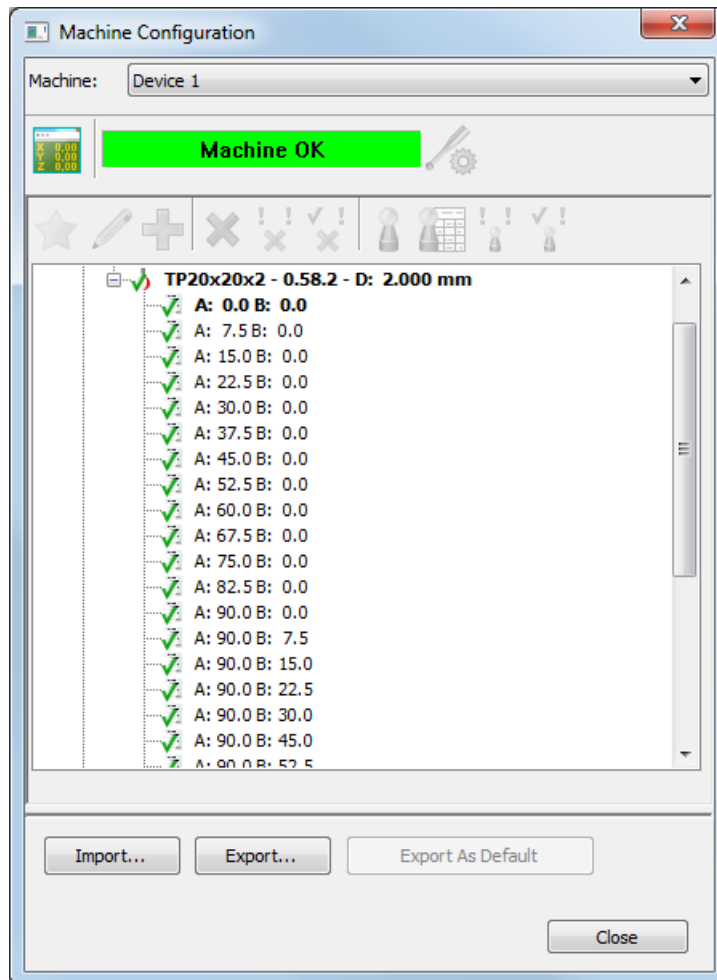

- 3 By default, the dialog displays the details of the probe on the last column you selected. Select the other column in the **Machine** list to switch to its details and to display its probe in the full-screen view.
- 4 To show the position of the probe as it moves, click the **Tracking**  button. The **Coordinate** dialog is displayed.
 

 When the **Coordinate** dialog is displayed and you switch columns, the dialog remains open and continues to display the position of the probe on the previously selected column.
- 5 To return to the original column, select its entry in the **Machine** list.
- 6 When you have finished, click **Close** to close the dialog.

# PowerINSPECT settings

Several changes have been made to the settings in the **Options** dialog. To view and change the settings, select the **Tools > Options** menu option to display the dialog, and then select the page you want to work with.

## Display options page

By default, PowerINSPECT determines if a measured item is within tolerance using the item's exact calculated error value. The new **Use rounded error value to determine measure state** check box enables you to determine the tolerance status using the error value rounded to the specified **Number of decimal places**.



*Using rounded error values is useful when the accuracy of the measuring device is limited to a small number of decimal places.*

## Colours > General page

A new option on the **Colours > General** page enables you to change the colour of the grid lines (see page 34) shown in labels.

To change the colour of the grid lines:

- 1 In the list, select **Label gridline colour**.
- 2 Click the **Main Colour** swatch.
- 3 In the **Color** dialog, select an option, and then click **OK** to save your changes and close the dialog.

## Colours > Entities page

When you display labels for GD&T items (see page 32), an asterisk marker terminates the arrow that links the label to the feature. A new option on the **Colours > Entities** page enables you to change the colour of the marker.

To change the colour of the marker:

- 1 In the list, select **Label anchor**.
- 2 Click the **Main Colour** swatch to specify the colour of the marker.
- 3 In the **Color** dialog, select an option, and then click **OK** to save your changes and close the dialog.
- 4 Click the **Highlight Colour** swatch to specify the highlight colour of the marker when the GD&T item is selected in the inspection sequence, or the GD&T label is selected in the CAD view.
- 5 In the **Color** dialog, select an option, and then click **OK** to save your changes and close the dialog.



*To highlight the marker using the specified **Highlight Colour**, select the **Highlight entities using highlight colour** check box. Deselect the check box to highlight the marker by changing the luminosity of the specified **Main Colour**.*

## Colours > Tolerance band page

A new option on the **Colours > Tolerance band** page enables you to change the colour of the text in the tolerance scale for inspection groups and point clouds when they are displayed in the CAD view and in the report.

To change the colour of the text:

- 1 Click the **Text Colour** swatch.
- 2 In the **Color** dialog, select an option, and then click **OK** to save your changes and close the dialog.



*To revert to the original colour, click **Reset**.*

## Full screen measurement page

A new option on the **Full screen measurement** page enables you to select the **Turn Committing On Pause** button in the **Point Cloud Tool** dialog (see page 38) by default.

To select the button by default, select the **Commit point clouds on pausing** check box.

# Index

## C

CAD • 3, 4, 5, 6, 10  
  Tab • 3, 5, 6  
  View • 3, 4, 5, 20, 22, 25, 27

## D

Decimal places • 47  
Deviation • 16, 25, 27  
DMT file • 37  
Dual-column • 45

## E

Ellipses • 10, 41

## F

Feature probing dialog • 30, 45  
Filter display • 16, 23, 27

## G

GD&T • 32, 47  
Geometric item • 8, 10, 35  
Geometry explorer • 10

## L

Labels • 31, 32, 34, 35, 47

## M

Measure • 12, 14, 17  
Measuring device • 30  
Miscellaneous toolbar • 12  
Mouse context toolbar • 10

## N

Nominals • 8, 41  
Normal vector • 8

## O

Options dialog • 47

## P

Planes • 8  
Point cloud • 37, 38, 40, 44, 47  
  Acquisition parameters • 40  
  Features toolbar • 41  
  Scanning • 38, 40, 41

## R

Report • 12, 14  
Report note item • 12, 14  
RPS alignment • 17

## S

Section • 16, 17, 20, 22, 25, 27  
  Shading • 20  
  View • 22, 23, 25, 27  
STL file • 37

## T

Tolerance • 25, 27, 35, 47  
Toolbar  
  Mouse context • 10  
  Point cloud feature • 41  
  View options • 25, 27, 32, 34, 35  
Tools menu • 47

## V

View options toolbar • 25, 27, 32, 34, 35

## W

Wireframe checker • 10