

Advanced
Manufacturing
Solutions

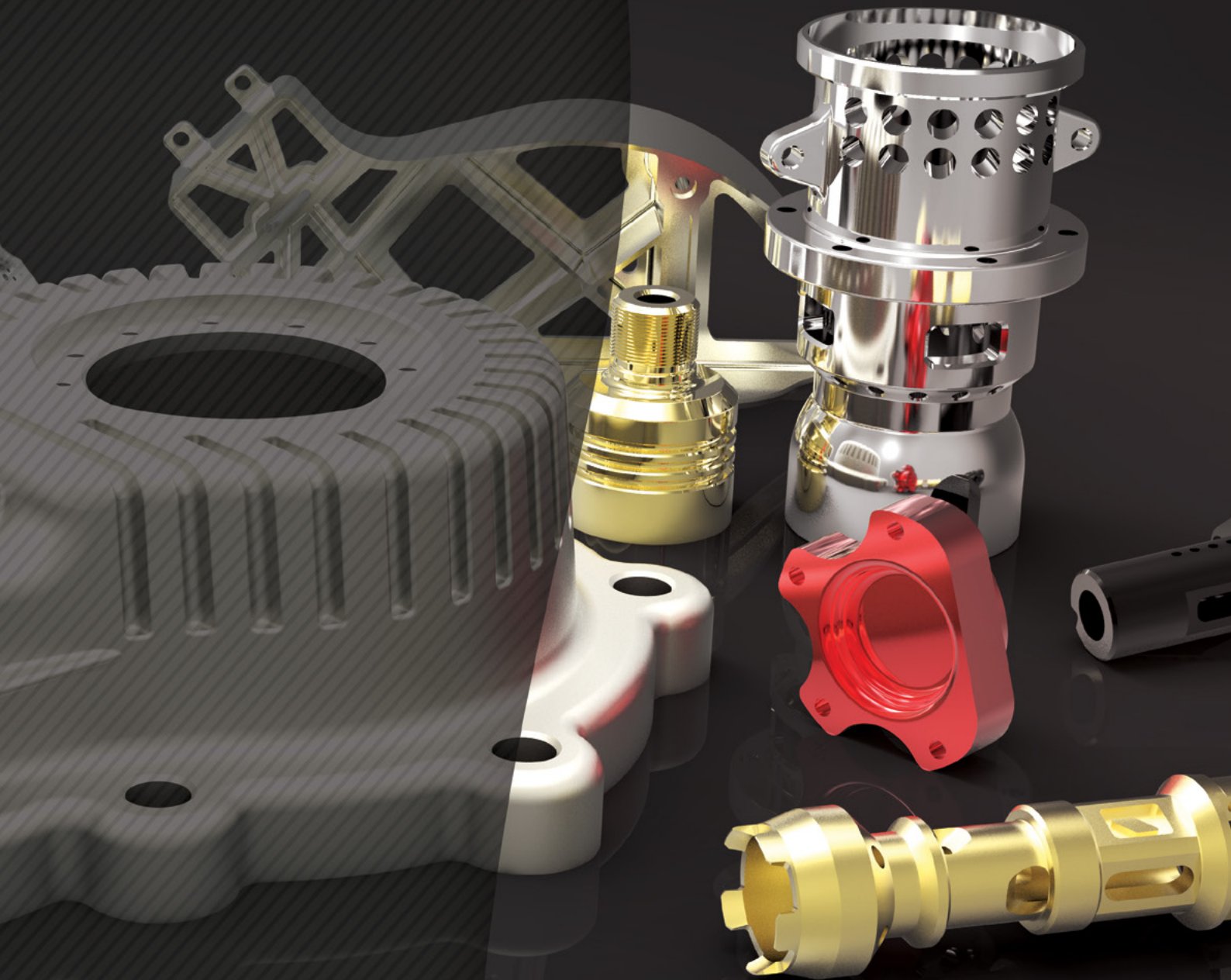

FeatureCAM

Feature-based CAM software for
mills, multi-tasking lathes and wire EDM

www.featurecam.com

- A wholly-owned, independently-operated subsidiary of Autodesk
- 150 offices and partners in over 80 countries
- More than 800 employees
- The world's largest CAM development team*
- 50,000 customers worldwide
- 40 years of experience developing CAD/CAM solutions
- Headquartered in a purpose-built 63,000 sq. ft. facility in Birmingham, UK

DID YOU KNOW ? Delcam develops all its machining code in-house and tests it in its own Advanced Manufacturing Facility.



Powering your productivity

PowerMILL

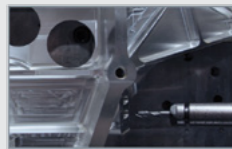

PowerMILL is the world's leading specialist NC CAM software for the manufacture of complex shapes, providing advanced machining strategies to minimise machining time and maximise finish quality.

PowerSHAPE



PowerSHAPE integrates surface, solid and triangle modelling. Design complex 3D models from scratch, or prepare imported data for manufacture, quickly, simply and accurately.

PowerINSPECT

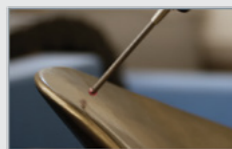

PowerINSPECT delivers a CAD-based inspection solution that can accept data from all types of hardware, including manual and CNC coordinate measuring machines, portable arms, optical measuring devices, and CNC machine tools.

FeatureCAM



FeatureCAM is the unique CAM system that uses feature-based and knowledge-based technologies for automated machining, minimising programming times for mills, multi-tasking lathes, turn/mill, and wire machines.

Delcam for SolidWorks



Delcam for SolidWorks is an integrated CAM system for SolidWorks for programming milling machines, turning and turn/mill centres, and wire EDMs.

PartMaker



PartMaker applies a Patented Visual Programming approach to automate the programming of multi-axis Swiss-type lathes and Turn-Mill Centres.

Connect with Delcam

www.delcam.com | www.delcam.tv | www.delcam.tv/lz | www.youtube.com/delcamams
www.facebook.com/delcamams | www.twitter.com/delcamams

*According to CIMdata

FeatureCAM

Feature-based CAM software for mills, multi-tasking lathes and wire EDM



Which of these is most important to you when choosing an automated CAM system?

- Ease-of-Use
- Speed
- Flexibility
- Scalability
- Reliability
- All of the above?

FeatureCAM automates the creation of reliable NC code for a wide variety of machine tools including mills, routers, multi-tasking lathes and wire EDMs. Minimise errors and reduce training costs by using a single CAM system to program all your machine tools.

Easy-to-use

FeatureCAM's intuitive interface, feature-based approach, and automation make it easy to use and fast to learn, reducing your training costs.

Fast

FeatureCAM generates toolpaths using multiple-cores, 64-bit processing, and high-performance algorithms, shortening your lead times and getting your machines cutting metal sooner.

Flexible

FeatureCAM provides a wide range of machining technologies, enabling you to program any type of machine, from mills to multi-tasking lathes and wire EDMs, quickly and efficiently.

Scalable

FeatureCAM's modular structure lets you grow your CAM system as you grow your business.

Reliable

FeatureCAM is based on over 30 years of continuous development and shares technology with other Delcam products, resulting in some of the most thoroughly tested toolpaths available in any CAM system.

DID YOU KNOW ? Feature-based CAM is up to 5 times faster than conventional programming.

FEATURECAM 2.5D MILLING

Do you need to program 2.5D parts faster and more simply, with automation and control?

In a busy production environment every second counts, and it is essential that you produce parts as quickly and cost-effectively as possible. Whether you start with a print, imported 2D data, or 3D CAD model, FeatureMILL 2.5D will create reliable NC code fast, helping you produce more parts faster.

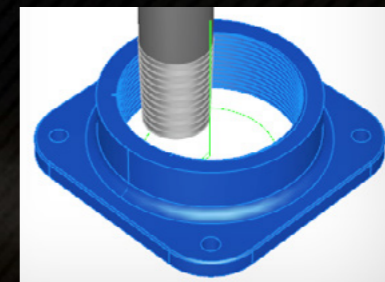
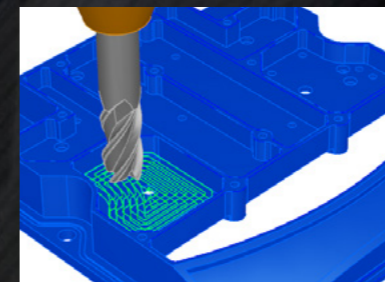

FeatureMILL 2.5D includes:

- 2D features - holes, pockets, faces, slots, sides, chamfers and bosses
- Feature patterns
- Engraving
- 4th axis indexing and feature wrapping

FeatureCAM uses patented High Speed Machining technologies in all modules, so that your machine tools run at optimum efficiency. In combination with FeatureCAM's simple-to-use automation, this minimises the time between starting a project and holding a finished part in your hand.

BENEFITS

Comprehensive libraries of materials and tools to automate selection of all appropriate machining parameters

User-defined tool 'cribs' that only use tools available on your machine

Large library of proven post-processors so you can get your machine running sooner

Advanced machine simulation that shows you precisely how your machine will perform, eliminating costly errors

Automatic re-ordering of machining operations, to reduce tool-changes

Steps and Wizards to guide you through unfamiliar processes, reducing learning times

DID YOU
KNOW



Knowledge-based
machining reduces
programming
times, as well as
eliminating costly
errors.

“FeatureCAM has really cut programming times in half. It's helped us to get our products out more quickly.”

Steve King, Virginia Panel Corp

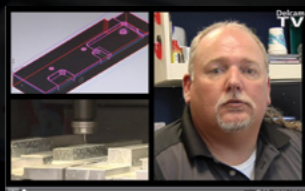

www.delcam.tv/virginia_panel

FEATURECAM 3D MILLING

Do you need to make complex parts?

Complex aerospace components, moulds, dies and automotive parts often require a combination of 2D and 3D machining strategies. FeatureMILL 3D adds a range of 3-axis milling capabilities, enabling you to broaden the range of work you can take on. With the same interface as all other FeatureCAM modules, FeatureMILL 3D is fast, powerful, flexible and easy-to-use. FeatureMILL 3D is modular, so you can grow your software as you grow your business.

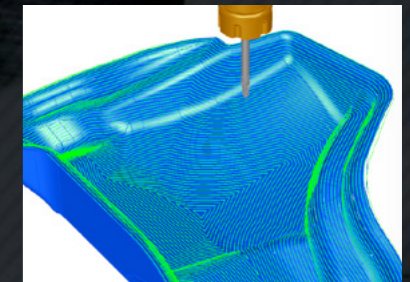
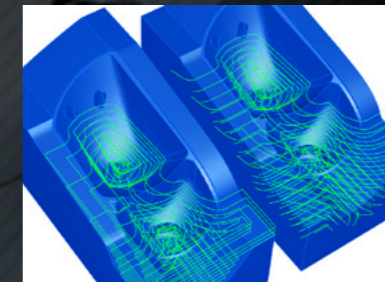
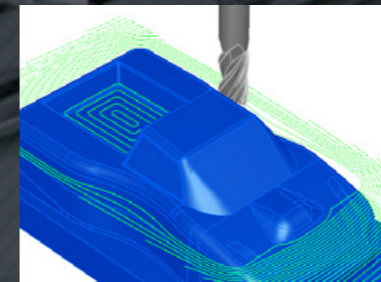

FeatureMILL 3D Lite

FeatureMILL 3D Lite adds the ability to machine complex free-form single surfaces. For parts that are mainly prismatic, but have a few 3D faces as well, FeatureMILL 3D Lite provides a cost-effective solution. Select the surface to machine, and then choose the tools and strategies you need. FeatureMILL 3D Lite will also recognise all sharp edges in the 3D model, and chamfer them automatically.

FeatureMILL 3D MX

FeatureMILL 3D MX provides the ability to machine multiple surfaces. The wide range of strategies available in FeatureMILL 3D MX enable you to tackle more complex jobs, simply and efficiently.

FeatureMILL 3D HSM

FeatureMILL 3D HSM is the complete 2 and 3D machining solution enabling you to take on the most challenging of programming tasks. FeatureMILL 3D HSM provides unrivalled power and flexibility, and includes all of FeatureCAM's powerful milling strategies and many shared with Delcam PowerMILL, including Vortex - Delcam's latest high speed roughing technology.

BENEFITS

Uses the same interface as all FeatureCAM modules, so is easy-to-use and quick to learn

Fully scalable allowing for steady growth of your business

Knowledge-based programming gives consistent results, independent of user experience level

Wide range of powerful machining strategies, enabling you to make very complex parts quickly and simply

“We don't have time to play with programming. Here we need it to work first time out. FeatureCAM helps us reach that goal.”

Paul Johnson, Robinson Helicopters
www.delcam.tv/robinsonhelicopters

Vortex

Revolutionising High Speed Roughing

Vortex* is Delcam's latest high-speed area clearance technology. Deeper cuts use the full flute length as the cutting surface, allowing you to gain the maximum benefit from solid carbide tooling and reduce machining times by up to 60%. It can be used for 2 and 3-axis roughing, positional 5-axis area clearance and for rest machining based on stock models or reference toolpaths.

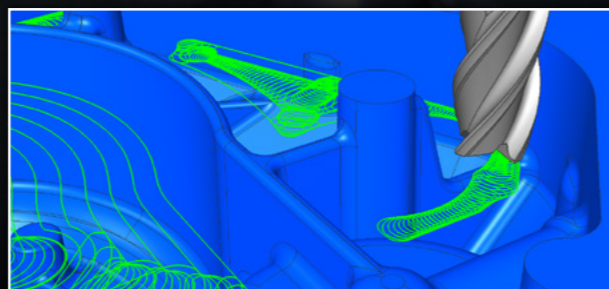

*Patent pending

5-AXIS MILLING

FEATURECAM

Do you want to reduce setup times while improving part quality?

5-axis machining enables you to machine complex parts with shorter cutters, reducing vibration and improving surface finish. You can machine the whole part in a single setup, saving you time, and eliminating errors.

FeatureCAM 5-axis provides both positional and continuous 5-axis control, offering a wide range of strategies to make programming your multi-axis machines simple. Powerful collision avoidance and gouge protection ensure that the tool axis is re-aligned automatically if any part of the tool or tool-holder assembly interferes with the part. Tool motion is kept as smooth as possible, eliminating dwell marks and tool chatter, giving you the best quality parts quickly and efficiently.

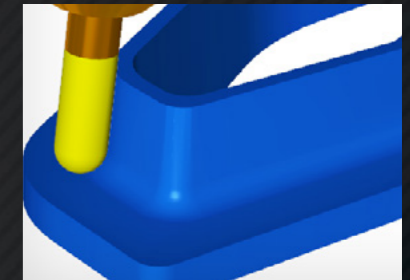
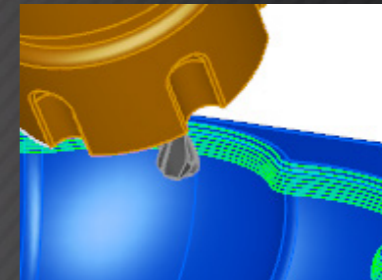
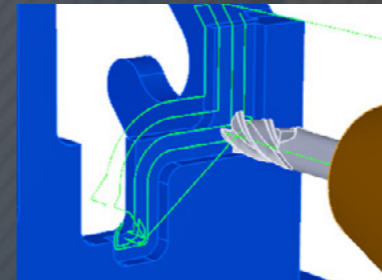

BENEFITS

OF POSITIONAL 5-AXIS

- Can be used on horizontal or vertical machine centres
- Simplifies machining of deep cores and cavities
- Enables you to use shorter cutters, improving surface finish
- Reduces setups, saving you time and money, while eliminating setting errors
- Allows easy access to undercut regions

BENEFITS

OF CONTINUOUS 5-AXIS

- Enables you to machine very complex parts, using a wide range of strategies
- Produces high quality parts through collision avoidance with smooth tool motion
- Uses any type of tool geometry for greater flexibility
- Provides full gouge prevention for reliable production
- Machines all types of 3D model, including STL

FeatureCAM is an enormous competitive advantage. It cuts down on our programming times and our setup times for any type of new part.

Matt Watts, SFI

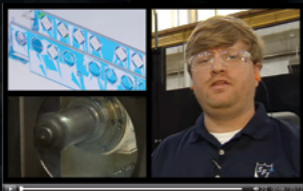

www.delcam.tv/sfi

DID YOU KNOW



You can change the machine tool at any time, and FeatureCAM will re-create all the G-code automatically.

WHAT MAKES FEATURECAM UNIQUE?

FeatureRECOGNITION

Do you want to put your CAD data to work, for everything from the simplest parts to the most complex?

Programming basic features such as holes, pockets and bosses manually is not only tedious but wastes valuable machining time and is prone to error. FeatureCAM's powerful FeatureRECOGNITION recognises a wide variety of features, either interactively or fully automatically, and then creates the NC code needed for your machine tools using its knowledge-based rules. FeatureCAM's built-in, fully customisable FeatureRECOGNITION finds and machines:

- 2D features such as holes, pockets, faces, slots, sides, chamfers and bosses
- 3D features such as angled holes and indexed features
- Turn features such as grooves, bores and turned profiles
- Turn/mill features such as indexed holes and pockets

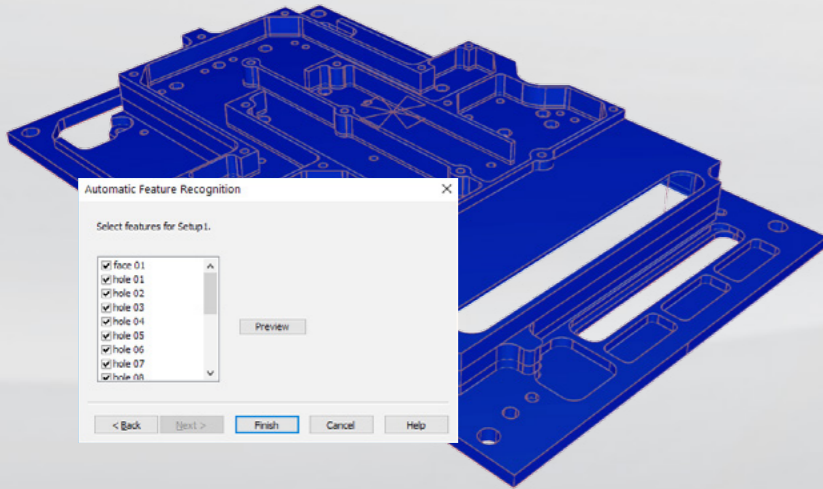

BENEFITS

Machining of basic features is automatic, but totally controllable and easy to configure

Features and NC code are associative; if the feature design changes, the NC code updates automatically

Features will be found, even if they overlap or intersect

Leaves you more time to concentrate on more challenging issues

BENEFITS

Easy-to-use and simple to set up, with built-in knowledge and carefully selected default parameters so you can start machining straight away

Large tool database installed and ready-to-use

Automates your processes using your own knowledge and experience

Guarantees consistent results for all users in your organisation

Automation

Do you want the best of both worlds – automation and control?

FeatureCAM's knowledge-based technology gives you a powerful CAM system that combines automation with complete control. FeatureCAM generates toolpaths based on the features of the part and selects appropriate tools, strategies, and machining parameters automatically. This machining know-how is built-in but fully configurable; you can edit it to suit your own company standards or individual preferences.

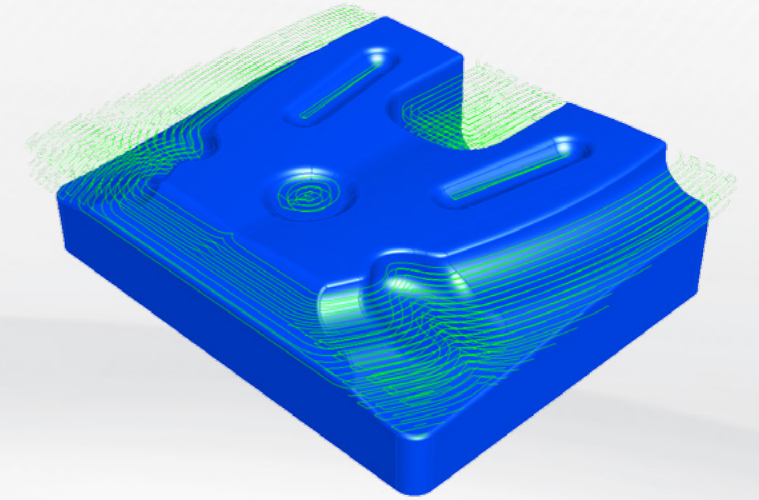

Ease-of-Use

Do you want a CAM system that learns how you like to program?

FeatureCAM has been designed to be easy-to-use while retaining the power you need to produce parts quickly. With its obvious and clear interface and step-by-step Wizards to guide you through more complex tasks, FeatureCAM is easy-to-use for casual users while retaining the power needed by experts. To shorten learning times further FeatureCAM dialogs have built-in help illustrations and animations, helping you to learn as you work.

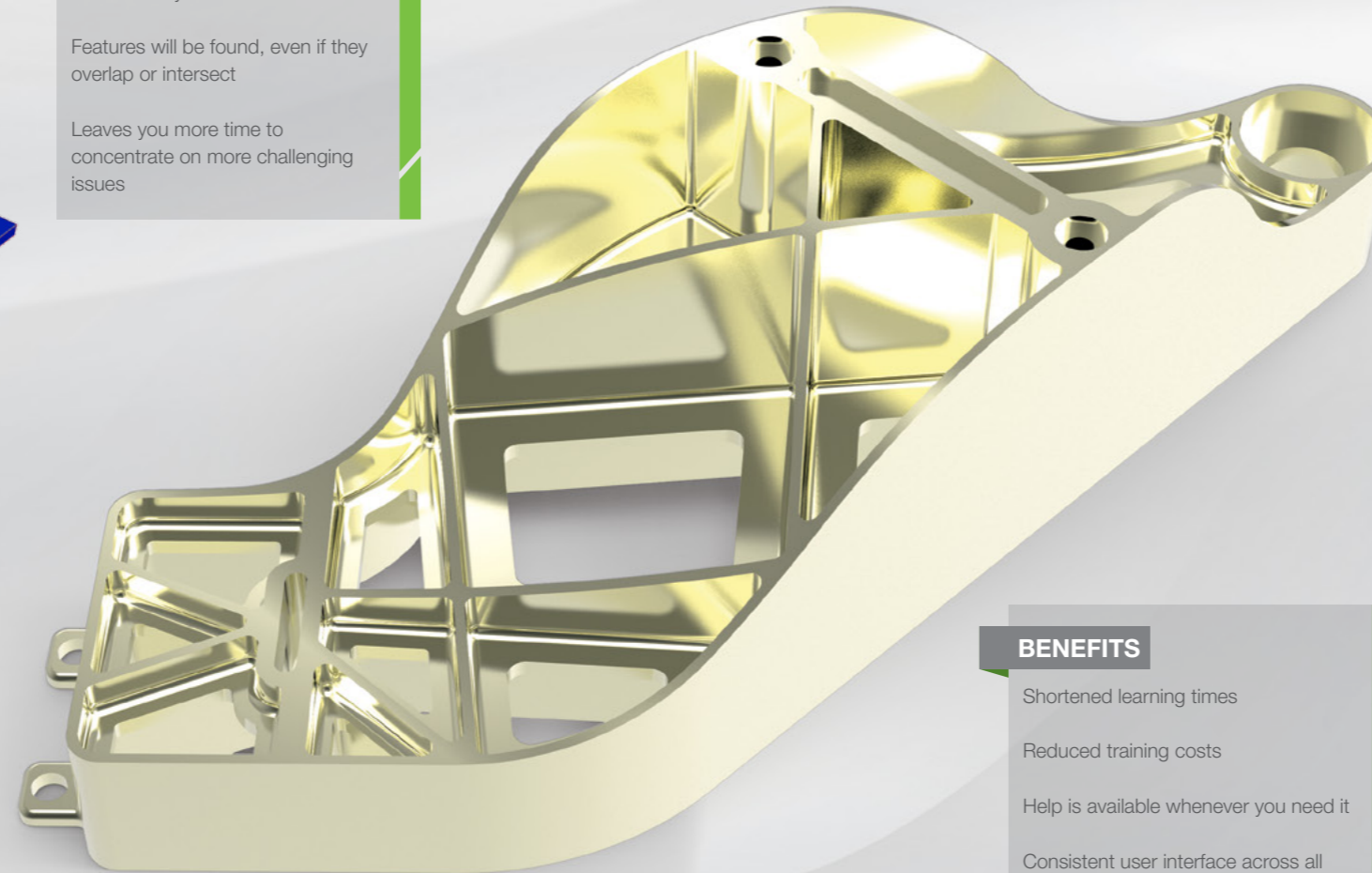
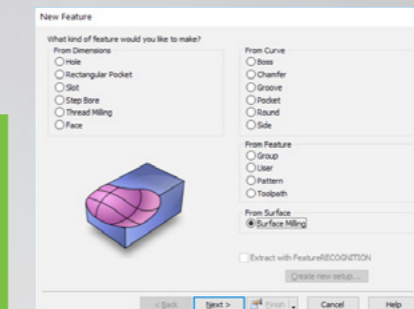

BENEFITS

Shortened learning times

Reduced training costs

Help is available whenever you need it

Consistent user interface across all product modules

Customisable toolbars and interface

“ I like the fact that it's feature-based. FeatureCAM looks through the tool and material library, grabs the tools you need and does it all for you. ”

Jason Oakes, Oakes Manufacturing
www.delcam.tv/oakes

DID YOU KNOW



Feature-based operations can be edited manually for full control of any tool move.

FEATURECAM TURNING

Do you need to produce high quality turned parts quicker?

FeatureTURN lets you take full advantage of your NC turning centre to produce turned parts quickly and efficiently. Powerful but easy-to-use, FeatureTURN uses FeatureCAM's FeatureRECOGNITION to accelerate programming by choosing appropriate tools and settings automatically, based on the part's geometry. Parts can be designed quickly and intuitively or imported from any other CAD system. Toolpaths are fully associative with the part, so if any feature changes, all affected G-code is recreated automatically.

FeatureTURN has a comprehensive library of standard thread forms, both Metric and Inch, making programming even simpler. Turning operations can be ordered intelligently to prevent scarring from swarf being dragged along the part. FeatureTURN takes full advantage of your machine's canned cycles, reducing program size and giving shorter machining times.

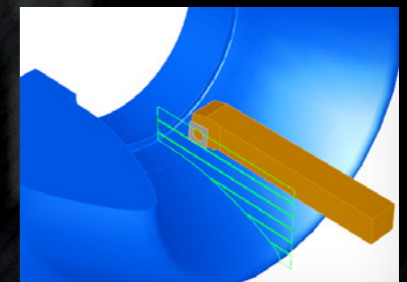
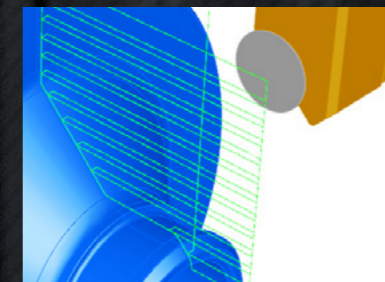

BENEFITS

Produce more parts faster by reducing programming times

Gain consistent results through fully customisable knowledge-based programming

Check programs quickly and accurately, preventing scrap using built-in graphical simulation

Avoid damage caused by swarf build-up, using No-Drag turning

Use continuous material feed utilising bar-feeding and pull-feeding, or utilise the sub-spindle for even greater flexibility

DID YOU
KNOW



You can add your own routines for any feature at any time, for ultimate customisation.

“FeatureCAM allows us to make the best products, at the best price and get it to the consumer in the quickest time possible.”

Aaron Jensen, Silencerco



www.delcam.tv/silencerco

FEATURECAM TURN/MILL

Do you want reliable production of precision parts on everything from the simplest turn/mill equipment to the most complex?

Modern turn/mill machines can produce high-quality precision parts quickly. The challenge is to create the most efficient toolpaths possible, so you can make parts faster, and maximise your profitability. FeatureTURN/MILL combines FeatureTURN with FeatureMILL 2.5D enabling you to program any combination of milled or turned features in a single setup, and make full use of multi-tasking machines.

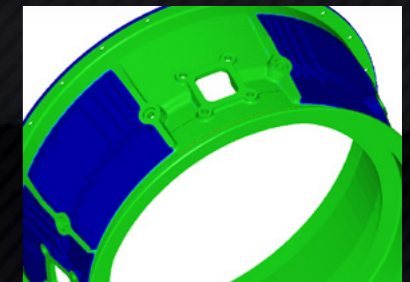
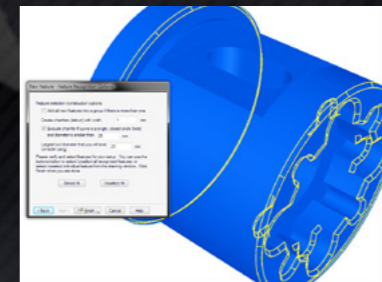
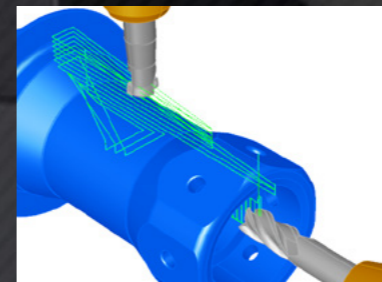

FeatureTURN/MILL adopts the same knowledge-based philosophy as all FeatureCAM modules. Lead times are shortened through the automatic selection of all tools, strategies and settings based on the geometry of the part. Turning and milling operations are re-ordered automatically to provide the shortest possible cycle time.

For dual spindle, multi-turret machines with B-axis control, FeatureCAM Multi-Turret Turning (MTT) enables you to carry out 5-axis machining operations on your turn/mill machine. With efficient part transfer between spindles, and the ability to turn with live tools on 4 separate turrets, FeatureCAM MTT enables you to make complex parts in the shortest possible time.

BENEFITS

- Maximise your return-on-investment by using fully proven post-processors to shorten machine commissioning times
- Machine parts faster with Multi-Turret technology for turning and turn/mill
- Better handling of interrupted cuts and improved chip breakage for significantly higher part quality
- Use any common configuration of machine, including those with C or Y-axis milling, and sub-spindles
- Reduce your manufacturing costs by machining complex parts in a single setup
- Increase programming speed through knowledge-based automation

DID YOU
KNOW



FeatureCAM's
knowledge base
is stored centrally,
so any changes
you make are
instantly available
to all users.



Some of the jobs we were programming used to take a day. With FeatureCAM we can knock it down to a couple of hours.

Gary Skraga, Coventry Engineering Group

FEATURECAM FOR WIRE EDM

Do you need fast, accurate control of wire EDMs?

FeatureWIRE uses the same knowledge-based approach as all other FeatureCAM modules, enabling you to program 2 and 4-axis wire EDMs with ease. Based on the geometry of the part, FeatureWIRE selects all appropriate settings automatically, generating ready-to-use toolpaths in seconds. Suitable for all types of wire EDM applications and machines, FeatureWIRE will reduce your programming times and help you produce high accuracy parts quickly and simply.

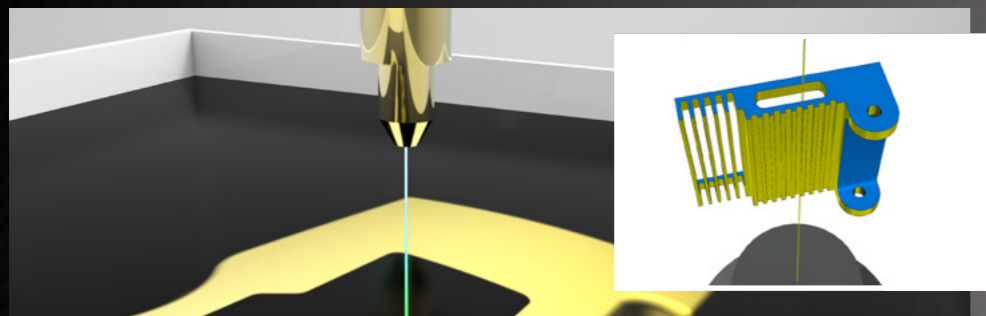

BENEFITS

Reduce programming time through fully customisable knowledge-based automation

Avoid wire breakage and subsequent down-time by using the cutting conditions database to choose all appropriate settings automatically

Reduce machine commissioning times through proven post-processors for all industry-leading machines, including AgieCharmilles, Fanuc, Mitsubishi and Sodick

Increase the range of parts you can offer to your customers through FeatureWIRE's wide range of feature types, including dies, punches and sides

FEATURECAM FOR CNC PROBING

Do you want to make perfect parts on completely unattended machines?

FeatureCAM provides powerful probing routines that can check each feature as it is machined, and then decide automatically if the part is correct or needs further machining. This in-process verification solution enables automated 'lights out' machining of feature-rich parts, with support for multiple probing feature types. FeatureCAM CNC Probing lets your machines get on with their job while you get on with yours.

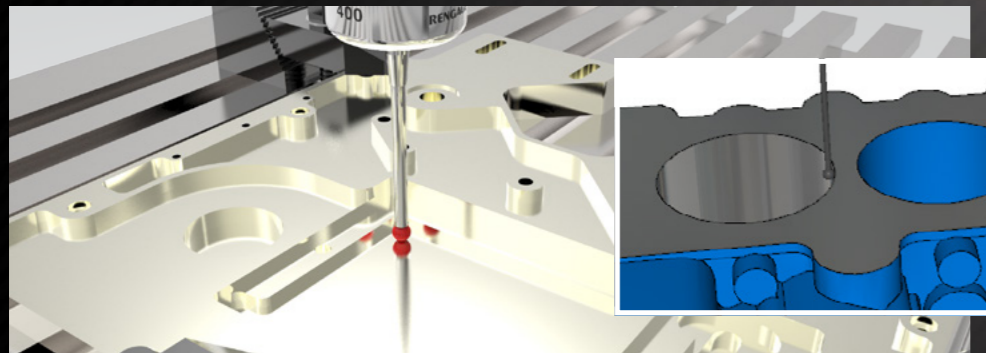

BENEFITS

Reduce wastage by checking for the presence of correct part or fixture

Optimise toolpaths for the exact amount of material being machined

Save time by minimising unnecessary re-cutting operations

Maximise machine usage by aborting cutting when required

Support for probing multiple feature types

BENEFITS

Reduce programming times by selecting orientations and coordinate systems automatically

Shorten production time by eliminating unnecessary tool changes

Eliminate scrap through full gouge avoidance of all parts of the tool assembly

Provide lean manufacture through maximised machine usage and reduced setup times

TOMBSTONE MACHINING

Do you want to machine the most parts possible on your horizontal mill?

FeatureCAM enables easy programming of machines with a tombstone table. Create the toolpaths for one part, and FeatureCAM will produce all necessary translations and rotations for all the rest automatically. Tombstone machining is available for both horizontal and vertical machining centres, giving you the flexibility to machine complex castings or production parts efficiently.

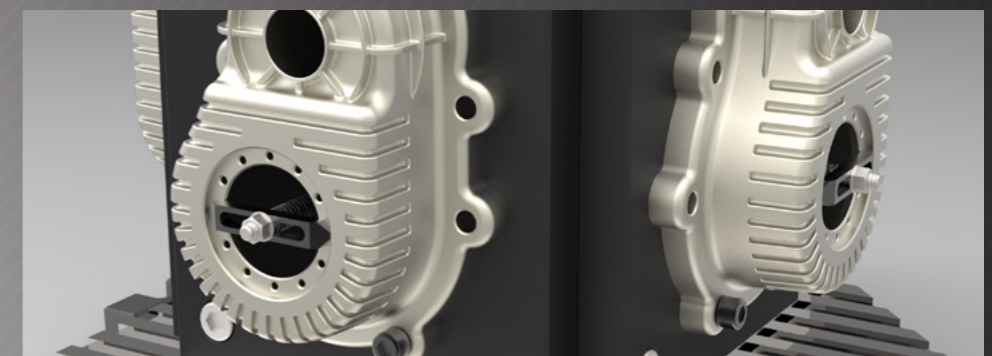

MACHINE SIMULATION

Do you want peace of mind that your toolpaths are always right?

FeatureCAM offers comprehensive machine simulation. Accurate, on-screen animations of your whole machine, tool assembly, stock and finished part, give you the peace of mind that you can run your programs safely. Machine simulation is fully customisable, so you can add your own machine tool if it is not already available. You can simulate the same set of toolpaths on a variety of machines, to help you decide which machine in your facility will be most appropriate.



FeatureCAM also provides interfaces to Vericut™, NCSIMUL™ and CAMplete™ for even greater flexibility.

TECHNICAL PARTNERSHIPS

With the largest development team in the CAM industry*, Delcam holds regular meetings with technical partners to make them aware of our latest innovations. In return, Delcam learns about new machine tool and cutting tool technologies. This assists with the development of new software features and enhancements to enable you to take maximum advantage of the latest industry equipment.



Technical Collaboration

Delcam has developed strong relationships with a wide range of key stakeholders in the CAD/CAM industry, helping you to take advantage of the latest generation of machine tools and cutting strategies.



Post Processors

With machines of all types becoming more sophisticated and complex, close relationships are also important in the development of post processors to ensure a smooth transfer of CAM programs to any new machines.

Research and Development

Delcam works with technical partners from enterprises, universities and R&D centres to jointly research, develop and implement cutting edge CAD/CAM technologies. Projects are jointly funded by partners and funding agencies such as the European Commission and the UK Technology Strategy Board. This enables Delcam to develop the latest technologies to benefit your production requirements both now and in the future.



SUPPORT & MAINTENANCE

Everyone knows that business costs must be kept as low as possible but some cost-cutting measures could actually cost you more in the long term. Software maintenance safeguards your business, letting you get the best possible return on your investment and helping you stay one step ahead of your competitors.

Protect Your Investment

Your machine tools are an expensive investment and it is essential that they perform as efficiently as possible. The CAD/CAM software that helps you run those machines is under continuous development, becoming ever more efficient and cost-effective. Software maintenance ensures you are always at the forefront, using the best technology available and maximising your return.



Avoid Costly Re-training

Software development moves rapidly with new features and functions added to every release. With two major releases a year, as well as intermediate patches, it does not take long to become out-of-date and to need complete re-training.

Get Help and Support

What happens when you hit a problem? With a maintenance contract, help is just a phone call or email away, in your own language, from your local Delcam Sales Partner. Delcam's support engineers are located at more than 300 offices worldwide and have thousands of man-years of experience between them. This knowledge and experience not only covers Delcam's products but also the specific manufacturing technologies and processes used within the market sectors that Delcam serves. The combination of all these resources ensures that whenever a problem occurs, your downtime is kept to a minimum by getting the help you need, when you need it.



Quickly Learn New Features

With every major release you receive a DVD kit containing a detailed "What's New" booklet to keep you fully up-to-date with all the latest tools and how to use them. You can also view tutorial videos on the new features and improvements from the Learning Zone at www.delcam.tv/lz, available in many different languages.



www.delcam.tv/dmg

“We've been working with Delcam for quite a number of years now. We find their software extremely flexible and very easy to use. A lot of our customers use Delcam; it's probably one of the most preferred systems on the market.”

Neil Stuart, DMG UK



www.delcam.tv/apn

“Delcam's technical support is great. We get upgrades and new software versions fast and implement them quickly. We can keep using 100% of our machines, be more efficient and make more money.”

Vincent Cote, APN

*According to CIMdata

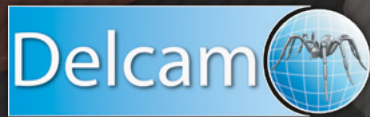

Advanced
Manufacturing
Solutions

Powering your productivity

Delcam
Small Heath Business Park | Birmingham | B10 0HJ | United Kingdom
Tel: +44 (0)121 766 5544

Delcam
3280 Electricity Drive | Windsor | ON N8W 5J1 | Canada
Tel: +1 877 335 2261

Delcam
275 E. South Temple | Suite 305 | Salt Lake City | UT 84111 | USA
Tel: +1 877 335 2261

www.delcam-ams.com | marketing@delcam.com

© Copyright Delcam Ltd 2016. All trademarks are the property of their respective owners.

