PowerSHAPE 2016

Reference Help

Mesh modelling



PowerSHAPE

Copyright © 1982 - 2015 Delcam Ltd. All rights reserved. Delcam Ltd. All rights reserved.

Delcam Ltd has no control over the use made of the software described in this manual and cannot accept responsibility for any loss or damage howsoever caused as a result of using the software. Users are advised that all the results from the software should be checked by a competent person, in accordance with good quality control procedures.

The functionality and user interface in this manual is subject to change without notice in future revisions of the software.

The software described in this manual is furnished under licence agreement and may be used or copied solely in accordance with the terms of such licence.

Delcam Ltd grants permission for licensed users to print copies of this manual or portions of this manual for personal use only. Schools, colleges and universities that are licensed to use the software may make copies of this manual or portions of this manual for students currently registered for classes where the software is used.

Acknowledgements

This documentation references a number of registered trademarks and these are the property of their respective owners. For example, Microsoft and Windows are either registered trademarks or trademarks of Microsoft Corporation in the United States.

Patent Information

Emboss functionality is subject to patent number GB 2389764 and patent applications US 10/174524 and GB 2410351.

Morphing functionality is subject to patent application GB 2401213.

Contents

Mesh modelling 3

Licensing of cloud and mesh modelling functionality	4
Importing a mesh	6
Selecting meshes	6
Selecting meshes using filters	7
Editing a mesh using the Mesh Edit toolbar	9
Picking method.....	10
Picking visibility	14
Select triangles.....	17
Create draft wall	20
Thicken mesh	21
Reduce the number of triangles	22
Refine mesh	23
Smooth mesh	26
Paint triangles.....	27
Morph mesh	28
Segment mesh	46
Shrink-wrap a surface onto a mesh.....	58
Dividing a mesh.....	61
Reverse a mesh	65
Fixing faults in a mesh.....	66
Fill holes	73
Stitch mesh.....	76
Resolve overlapping triangles	77
Z-compensation tool.....	78
Masking triangles on a mesh.....	79
Add triangle	82
Delete triangles	83
Sculpt meshes	85
Sculpting triangles - Add material.....	86
Sculpting triangles - Remove material.....	87
Sculpting triangles - Smooth.....	88
Sculpting triangles - Erase.....	89
Sculpting triangles - Show deviations	90
Combining selected meshes.....	92
Shading meshes	93
Renaming a mesh.....	96
Smooth shading of meshes	97
Smooth Normals dialog	98
Offsetting a mesh.....	100
Converting meshes.....	100

Converting to meshes	100
Converting a mesh to a solid	102
Creating curves.....	103
Create curve snapped to mesh	103
Creating a curve at discontinuities in a mesh	105
Create curves from mesh boundary	106
Surface from triangles.....	109
Boolean operations	110

Mesh modelling

A mesh comprises a set of triangles (typically in three dimensions) that are connected by their common edges. You can manipulate and edit the individual triangles.

The mesh functionality that is available is controlled by the product licence.

- **PowerSHAPE** provides basic triangle modelling functionality.
- **PowerSHAPE Pro** provides the following:
 - PowerSHAPE.
 - additional triangle modelling features.
 - reverse engineering features.
 - re-engineering features.

Use the licencing table (see page 4) to identify the functionality that is available with different licences.

Licencing of cloud and mesh modelling functionality

Use the following table and legend to see the triangle modelling functionality that is available with each licence.

	Not available
	Available

Tool	PS	Designer	PS Pro
Mesh Edit toolbar			
Add triangles (see page 82)			
Draft mesh (see page 20)			
Thicken mesh (see page 21)			
Reduce (see page 22)			
Refine (see page 23)			
Smooth (see page 26)			
Divide (see page 61) ☆			
Reverse (see page 65)			
Hole filling (see page 73)			
Mesh Doctor (see page 66)			
Stitch (see page 76)			
Remove overlaps (see page 77)			
Z-compensation (see page 78)			
Mask (see page 79)			
Delete (see page 83)			
Paint (see page 27)			
Morph (see page 28)			
Pick (lasso (see page 10)/select (see page 17))			
Cloud toolbar			
Generate mesh			

Tool	PS	Designer	PS Pro
Delete points			
General Edits toolbar			
Mesh/point cloud alignment			
Mesh limiting			
Cloud limiting			
Align items			
Sculpt (see page 85)			
Mesh offset			
Curve toolbar			
Oblique mesh			
Draft/horizon mesh			
Curves from intersections with meshes			
Curve from discontinuities (see page 105)			
Curve from boundaries (see page 106)			
Fit curves to mesh			
Surface/Solid/Solid Feature toolbar			
Fit surface to mesh			
Convert surfaces/solid to mesh (see page 100)			
Import mesh as solid (see page 6)			
Convert mesh to solid (see page 102)			
Booleans with meshes (see page 110)			
Combine (<i>Object > Mesh menu</i>) (see page 92)			
Triangle/edge shading options (<i>Views toolbar</i>) (see page 93)			
Error analysis (<i>Model analysis toolbar</i>)			

Tool	PS	Designer	PS Pro
Splitting using painted regions			
Import Point Cloud			
Import CCAD session			

★ Divide by selection is available only in PowerSHAPE Pro.

Importing a mesh

To import a mesh (.stl or .dmt file type):

- 1 Click the **Import**  button to display the **Select a File To Import** dialog.
- 2 Select a file and click **Open**.

Selecting meshes

Use one of the following methods to select a mesh:

- Filters (see page 7)
- Context menu

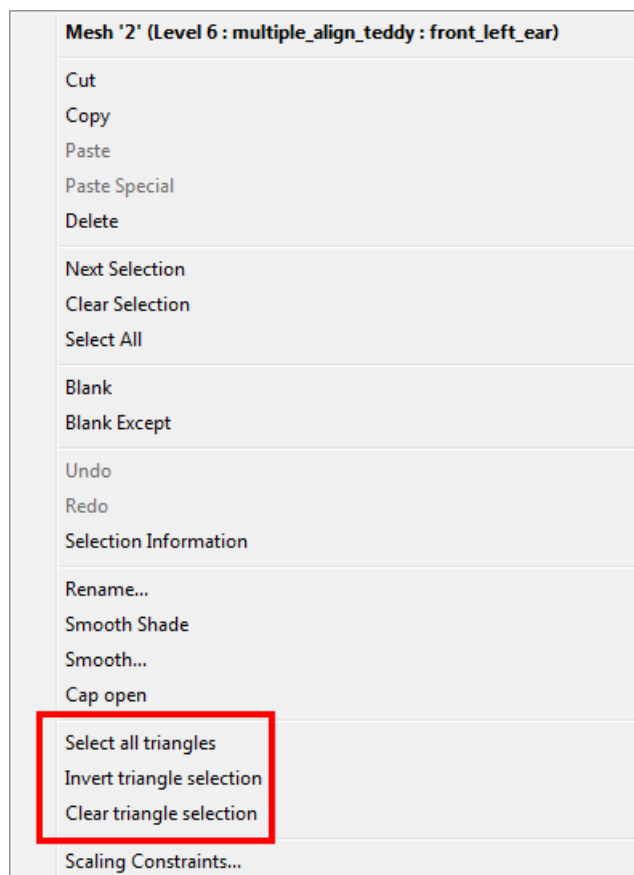

Select all triangles — Select this menu option to select all triangles.

Invert selection — Select this menu option to invert the triangle selection.

Clear selection — Select this menu option to clear the triangle selection.



Select a specific area of a mesh using the **Mesh edit** toolbar.

Selecting meshes using filters

Use the filters to select meshes in one of the following ways:

- Use **Quick select all meshes**  from the **Select** flyout to select all the meshes in a model.



Alternatively, select **Edit > Select > Quick Select > Meshes** from the menu.

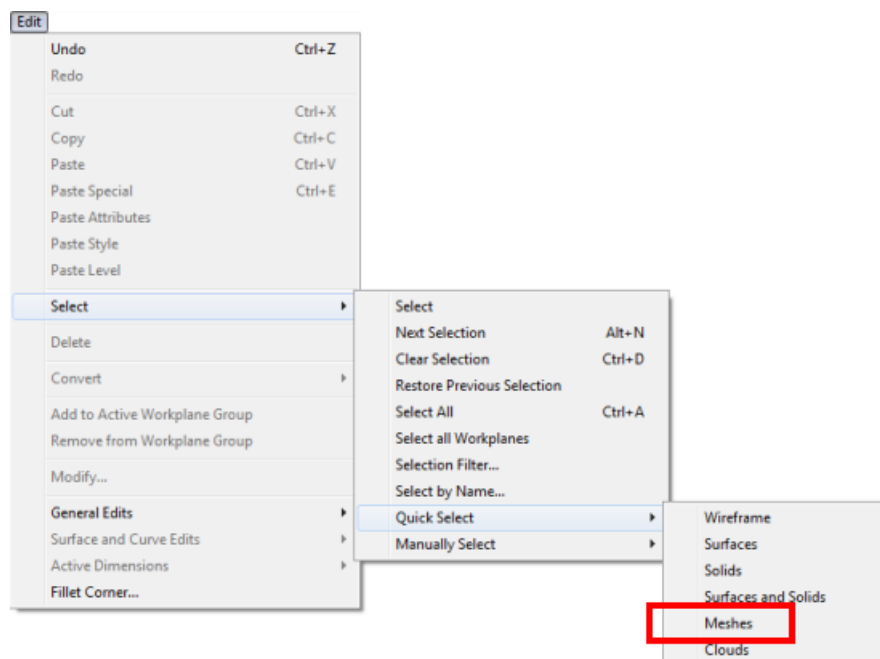

- Use the **Selection Filter** or **Manually Select** options on the **Edit > Select** menu.

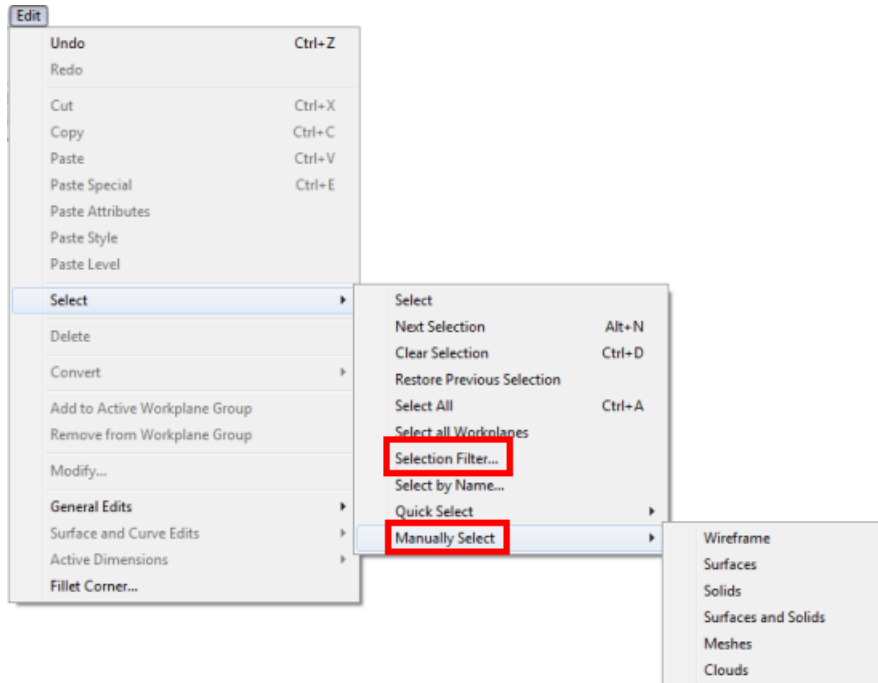

Editing a mesh using the Mesh Edit toolbar

Use the **Mesh Editing** options to modify your meshes.

- 1 Select one or more meshes to display the **Mesh Edit** toolbar.

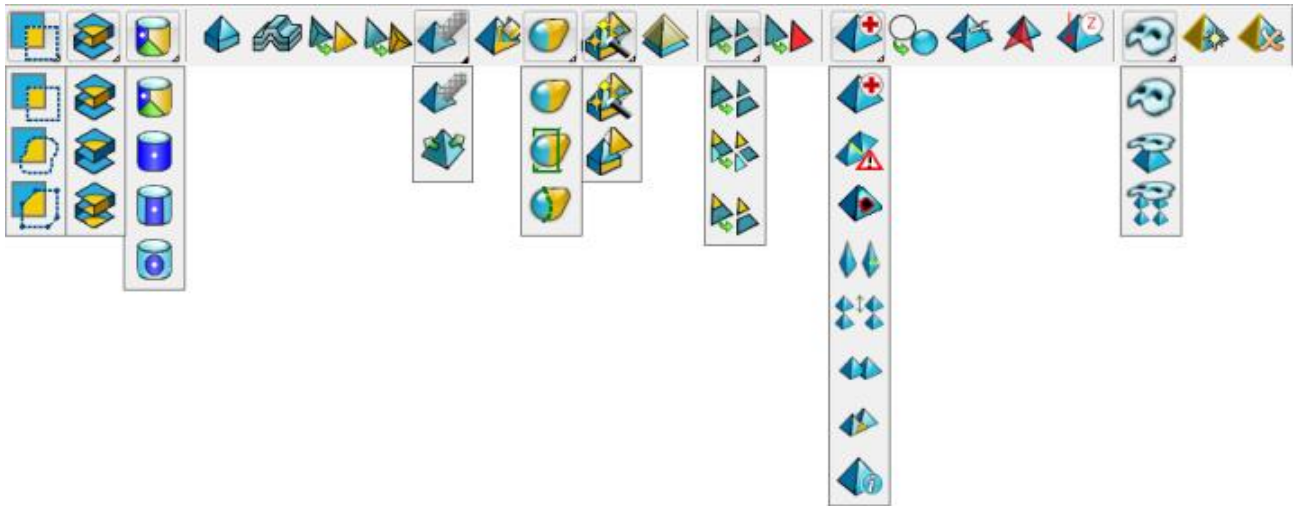

- 2 Click one of the following to edit the selected meshes:



Lasso (see page 10)



Picking visibility (see page 14)



Select triangles (see page 17)



Draft wall (see page 20)



Thicken mesh (see page 21)



Reduce the number of triangles. (see page 22)



Refine mesh (see page 23)



Smooth mesh (see page 26)















Smooth normals (see page 97)



Paint triangles (see page 27)



Morph mesh (see page 28)

-  Segment mesh (see page 46)
-  Shrink-wrap a surface onto a mesh (see page 58)
-  Divide a mesh into multiple meshes (see page 61).
-  Reverse triangles in the selected meshes (see page 65).
-  Open the Mesh Doctor to fix faults in the mesh (see page 66).
-  Fill Holes (see page 73).
-  Stitch the selected meshes (see page 76).
-  Resolve overlapping triangles in the selected meshes (see page 77).
-  Z compensation tool (see page 78).
-  Mask triangles (see page 79).
-  Add triangles (see page 82).
-  Delete triangles (see page 83).

The options can also be selected from the **Object > Mesh** menu.

Picking method

Use this flyout to define the boundary of the area of triangles to be picked.

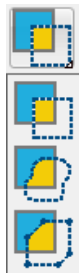

- 1 Select the required picking method from the flyout.



Select by
box



Continuous lasso (see page 11)



Discrete lasso (see page 12)

- 2 Use the selected method to pick the triangles on the mesh.
- 3 Deselect the picking method by clicking the button on the toolbar. Alternatively, click the **Select** button on the left-hand toolbar.

Modifier keys

Use the following modifier keys with box, continuous lasso, and discrete lasso triangle picking modes:

<i>No modifier</i>	Replace
	Add
	Invert
and	Remove

Continuous lasso

Use the **Continuous Lasso** to select individual triangles on the model.

- 1 Select the **Lasso Picking** button.
- 2 Click the start point on the model.

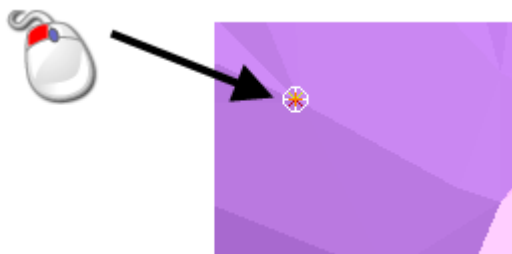

- 3 Click the model to create points to anchor the lasso. The lasso links the anchor points with straight lines.

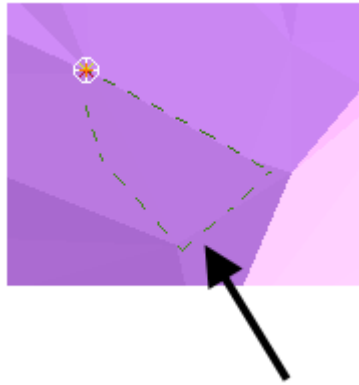

*To delete the last anchor point from the lasso, press **Ctrl** as you click anywhere on the model.*

- 4 When the lasso line encloses the entities you want to select, click on the starting point to create a closed selection polygon. The selection polygon is projected down the current view to select all the entities under the polygon.



When using the lasso to select triangles, only part of the triangle needs to be under the polygon in order to be selected.

Discrete lasso

Use  to pick triangles on a mesh using discrete lasso:

- 1 With an active mesh, select the **Discrete Lasso**  button from the lasso flyout.
- 2 Click the mesh to define the points on the boundary of the picking area.



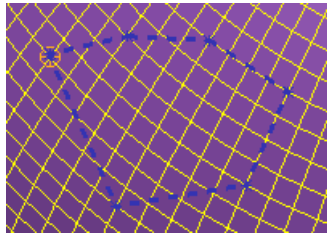

Undo your most recent point by hovering over it. When the cursor changes to , click on the point to remove it.

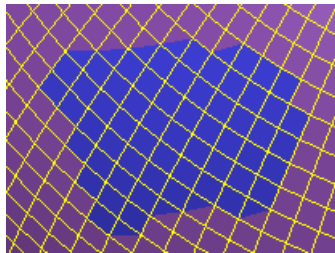

- 3** Move the cursor over the first point you entered. The cursor changes to .
- 4** Click the first point to complete the lasso, selecting the triangles within the polyline.

All the triangles that lie within picking area are selected.



*Press and hold **Ctrl** and click , or press and hold **Shift** and*

click  away from the model to deselect the selected triangles, but leave the mesh selected.

*Use **Ctrl+D** to deselect the selected triangles and the model.*

Picking visibility

Use **Picking visibility** flyout to specify the triangles that are visible.



The following example shows the effect of using the options on the **Picking visibility** flyout:

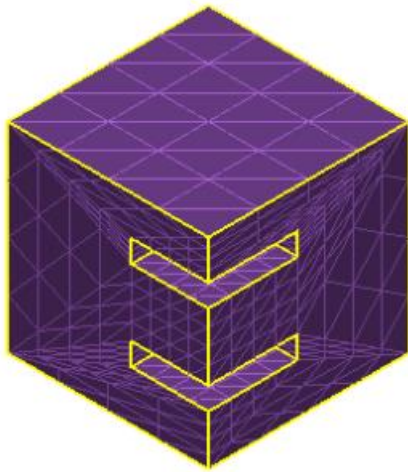

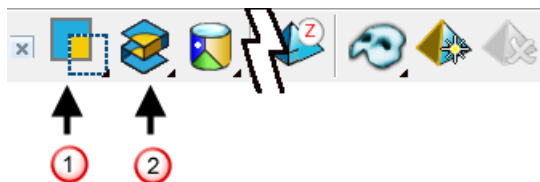

1 Select the mesh to display the **Mesh Edit** toolbar.

2 Click  option from the **Picking** flyout ①.



3 Select one of the following options from the **Picking visibility** flyout ②.

-  **Select all triangles on top** — Select this button to pick the triangles (visible and invisible) in the top part of the mesh.
-  **Select visible triangles on top** — Select this button to pick the visible triangles in the top part of the mesh.

-  **Select all triangles** — Select this button to pick all the triangles (visible and invisible) in the selected part of the mesh.

4 Box-select an area of the model.

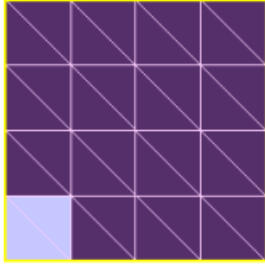

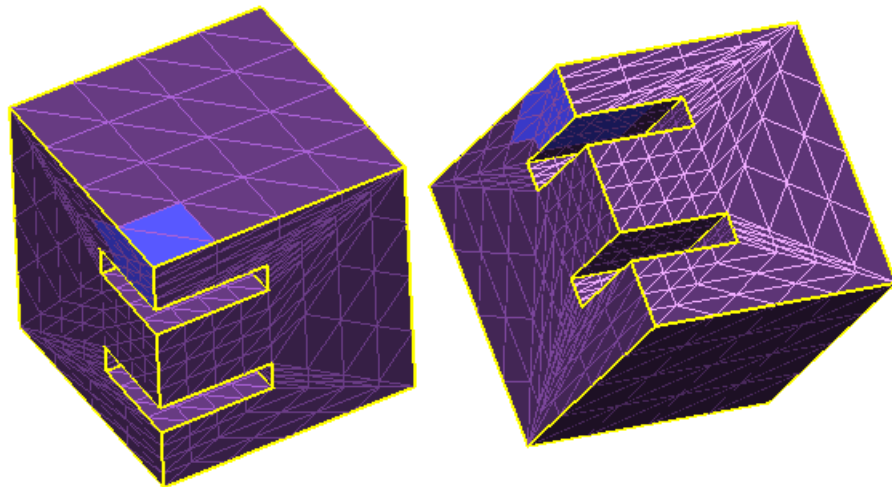

5 Rotate the model to see the selected triangles:

- Using the **Select all triangles on top**  button, the resulting selection is:

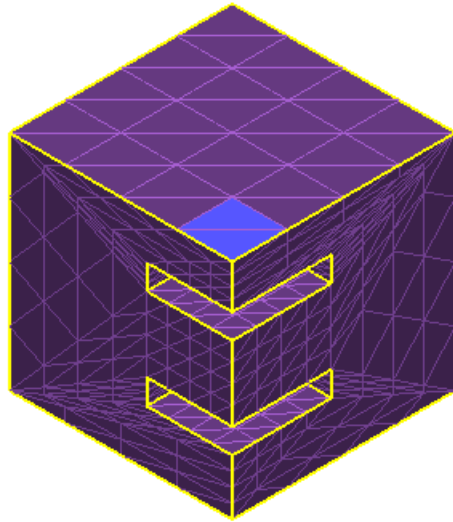

- Using the **Select visible triangles on top**  button, the resulting selection is:



- Using the **Select all triangles**  button, the resulting selection is:

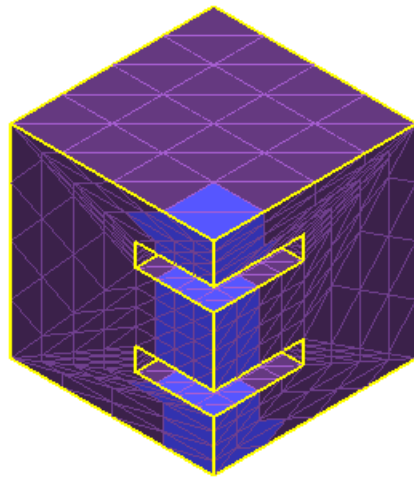

Select triangles

Use the **Select triangles** flyout to select triangles on a mesh.

- 1 With a mesh active, click  to display the buttons on the **Select triangles** flyout.



- 2 Select one of the following options from the **Select triangles** flyout:



Select triangles with the same colour



Select triangle area to discontinuity angle (see page 18)



Select triangle area to local horizon angle (see page 18)



Select triangle area to distance (see page 20)

Select triangle area to discontinuity angle

- 1 Select a mesh and click  to display the **Select Triangles** flyout.
- 2 Click the **Discontinuity Angle**  button to display the **Set angle** dialog.

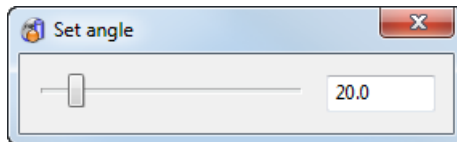

- 3 Click the model. Triangles are selected that lie within the discontinuity angle defined by the slider. Use the slider to increase or decrease the triangles that are selected. The example shows a cone with a 15° angle.

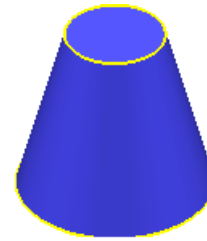
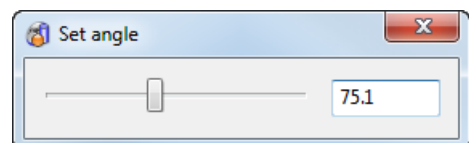
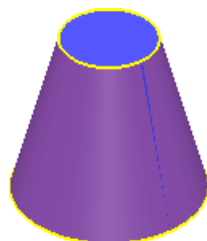
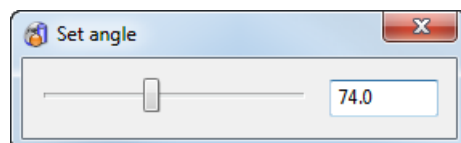
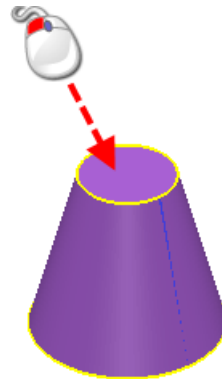

Select triangle area to local horizon angle

- 1 Select a mesh and click  to display the **Select Triangles** flyout.

- 2 Click the **Local Horizon Angle**  button to display the **Set angle** dialog.

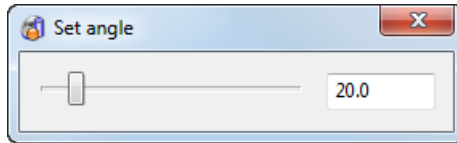

- 3 Click the model.



Triangles are selected that lie within the angle defined by the slider in the **Set angle** dialog.

- 4 Use the slider to increase or decrease the triangles that are selected.

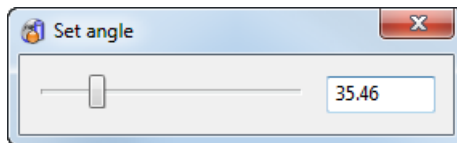

Select triangle area to distance

- 1 Select a mesh and click  to display the **Select Triangles** flyout.
- 2 Select the **Area to Distance**  button to display the **Set Distance** dialog.



- 3 Click the model.



Triangles are selected that lie within the distance defined by the slider in the **Set distance** dialog.

- 4 Use the slider to increase or decrease the triangles that are selected.

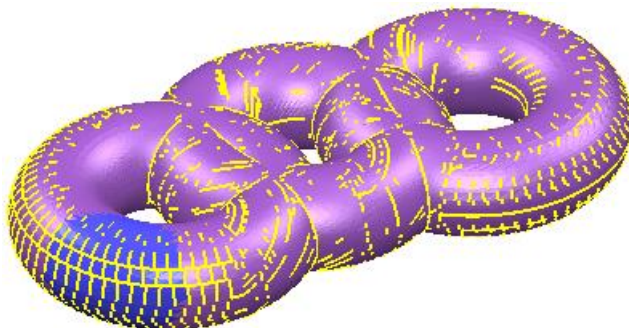
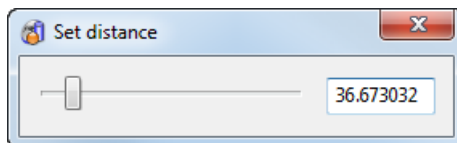

Create draft wall

This option is available only when using Delcam Designer or PowerSHAPE Pro.

- 1 Select one or more meshes to display the **Mesh Edit** toolbar.

- 2 Click the **Draft**  button to display the **Create Draft** dialog.

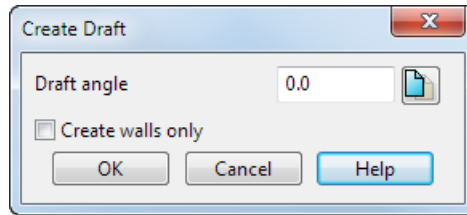

- 3 Enter a value for the **Draft angle**.
- 4 Select **Create walls only** to create the draft walls and remove the original triangles.
- 5 Click **OK**.

Thicken mesh

This option is available only when using Delcam Designer or PowerSHAPE Pro.

You can thicken meshes inwards, outwards, or in both directions. The default setting is to thicken in both directions, so that the original item is in the middle.

To thicken a mesh:

- 1 Select one or more meshes to display the **Mesh Edit** toolbar.

- 2 Click the **Thicken**  button to display the **Thicken Mesh** dialog.

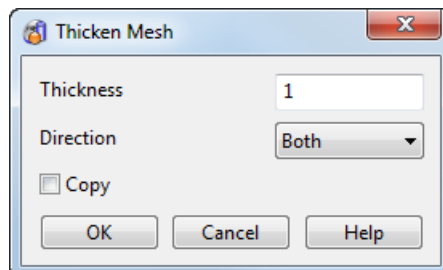

- 3 Enter a **Thickness** to set the thickness required for the mesh.
- 4 Select the **Direction**:
 - **Inward** — Select this option to apply the whole thickness in the inward direction.
 - **Both** — Select this option to apply half the thickness in each direction.
 - **Outward** — Select this option to apply the whole thickness in the outward direction.
- 5 Select the **Copy** option to thicken a copy of the mesh and keep the original unchanged.
- 6 Click **OK** to thicken the mesh and close the dialog.

Reduce the number of triangles

This option is available only when using Delcam Designer or PowerSHAPE Pro.

Use this option to reduce the number of triangles in the model.

1 Select one or more meshes to display the **Mesh Edit** toolbar.

2 Click the **Reduce Mesh**  button to display the **Reduce Mesh** dialog.

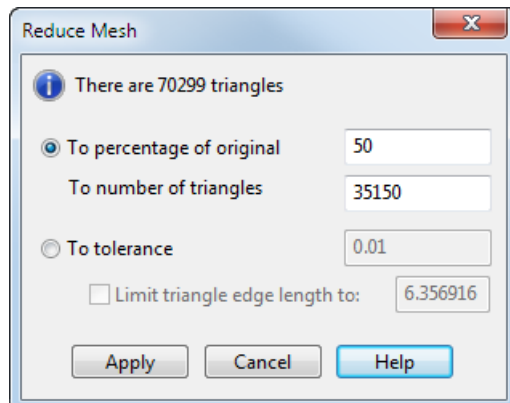

3 Specify the reduction parameters using one of the following methods:

- **To percentage of original** — Enter the percentage of the original number of triangles to be in the mesh.

For example, enter **75**. The number of triangles in the mesh is reduced by 25%, resulting in a less smooth mesh.

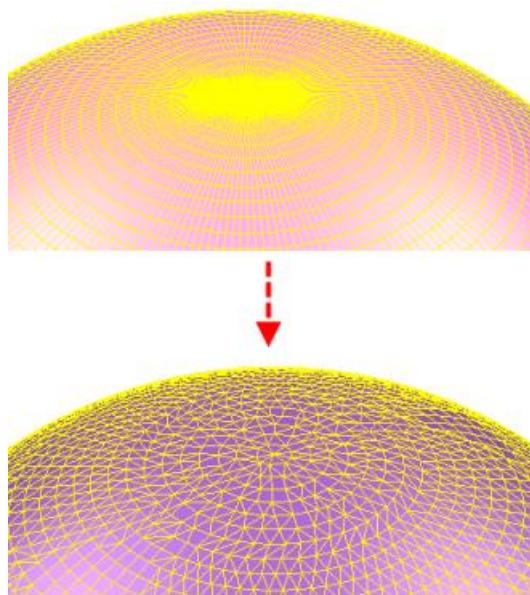

- **To number of triangles** — Enter the target number of triangles for the resulting mesh.

- **To tolerance** — Select this option and enter a tolerance to reduce the number of triangles. Optionally select **Limit triangle edge length** to specify the maximum edge length of triangles in the reduced mesh.
- 4 Click **Apply** to reduce the number of triangles in the mesh. The dialog remains open; you can change the values in the dialog to reduce the number of triangle again.
 - 5 Click **Cancel** to close the dialog.

Refine mesh

This option is available only when using Delcam Designer or PowerSHAPE Pro.

Use **Refine Mesh** to increase the density of triangles in the mesh by dividing each triangle into four new triangles.

The triangles are refined by curving the original triangles to create a smooth mesh. You can refine the mesh using a selected area or the whole mesh. This is useful for improving the smoothness of the mesh and can also be useful for subsequent operations (wrapping for example) that give better quality results on a higher density mesh.

- 1 Select a mesh.

- 2 Click the **Refine Mesh**  button to display the **Refine Mesh** dialog. The number of triangles in the selection or whole mesh is displayed, and you can change your selection while the dialog is open. Use this dialog to specify the method used to refine the triangles in a mesh.

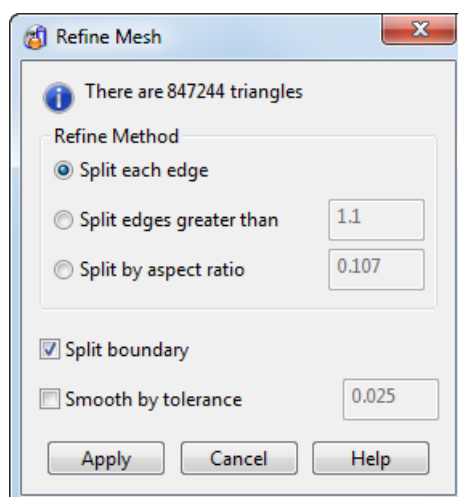

- 3 Choose the **Refine Method** to be used to calculate the vertices of the new triangles:

- Select **Split each edge** to subdivide each triangle into four new triangles by inserting new vertices in the middle of each edge.
 - Select **Split edges greater than** to subdivide triangles by inserting a new vertex in the middle of an edge when the length of the edge is greater than the specified value.
 - Select **Split by aspect ratio** to subdivide triangles with an aspect ratio of less than the specified value. The aspect ratio is the ratio of the height of the triangle divided by the length of the edge.
- 4 Select **Split boundary** to indicate that the triangles on the boundary edge are to be changed. The examples below show the effect of using this option.

Split boundary deselected:

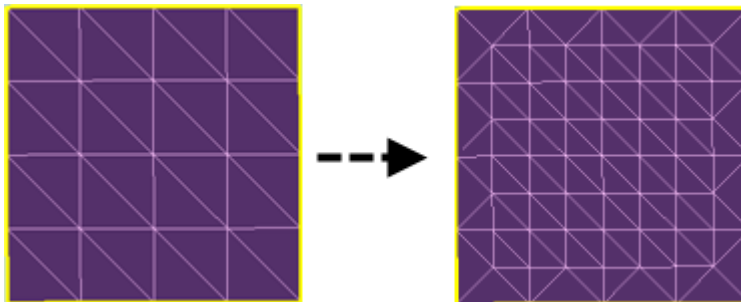

Split boundary selected:

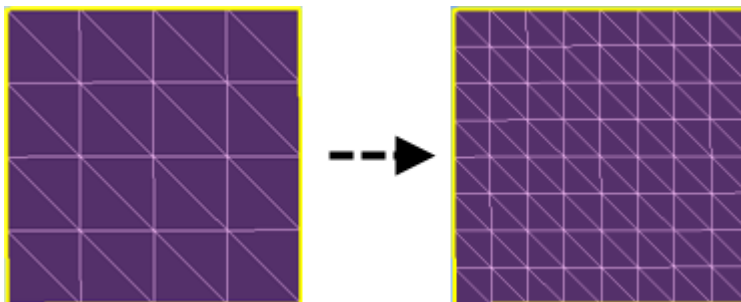

- 5 Select **Smooth by tolerance** to smooth the refined mesh by curving the triangles. Enter a value for the tolerance. The higher the tolerance, the more curved refinement will be possible, resulting in a less faceted model. The vertices of the triangles are calculated on the curved triangle if the deviation between the curved and the flat triangle is less than the tolerance you specified.

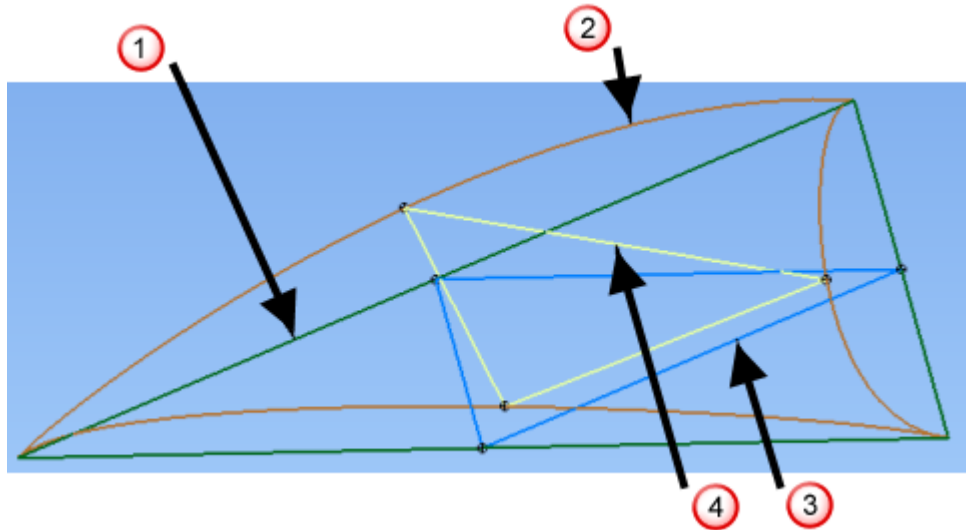

- ① Original triangle
- ② Curved triangle
- ③ New triangle calculated on original triangle
- ④ New triangle calculated on curved triangle

- 6 Click one of the following:
- **Apply** to refine the mesh without closing the dialog box. If required, you can refine the mesh further.
 - **Cancel** to close the dialog.

Smooth mesh

This option is available only when using Delcam Designer or PowerSHAPE Pro.

Use **Smooth mesh** to smooth the triangles in the mesh.

- 1 With a mesh selected, click the **Smooth Mesh**  button to display the **Smooth Mesh** dialog.

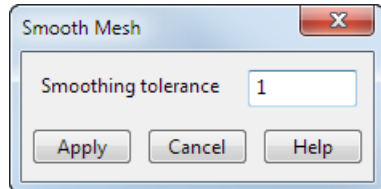

Use this dialog to filter out noise in a mesh.

- 2 Enter a **Smoothing tolerance**. This distance is used to determine the nodes that are affected by the smoothing process.



*If required, right-click **Smoothing tolerance** to display the calculator.*

In this example, a **Smoothing Tolerance** of **20** is used so that the results of smoothing are clearly visible. Normally a much lower figure is used.

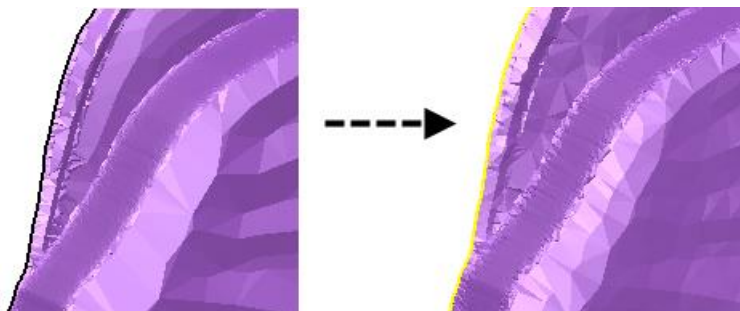

- 3 Click **Apply** to smooth the mesh and continue with smoothing.
- 4 When smoothing is complete, click **Cancel** to close the dialog.

Paint triangles

This option is available only when using Delcam Designer or PowerSHAPE Pro.

- 1 Click the **Paint Triangles**  button to display the **Paint Triangles** dialog.

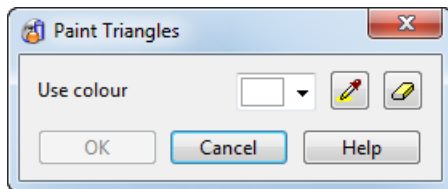

- 2 Select the colour to paint the triangles, using one of the following methods:

- Click the arrow  to display the colour palette



and select the colour you want to use. If the colour you want is not displayed in the palette, click the **Other** button to display the **Colour** dialog. Create a custom colour by specifying the values for **Hue**, **Sat** (saturation), **Lum** (Luminosity), **Red**, **Green**, and **Blue**.

- To use a colour that is already used in the mesh, click the **Pick Colour**  button and then pick colour on the mesh. The picked colour is displayed in the **Use colour** box.
- 3 Choose the method of triangle selection (see page 17):



Select triangles with the same colour



Select triangle area to discontinuity angle (see page 18)





Select triangle area to local horizon angle (see page 18)



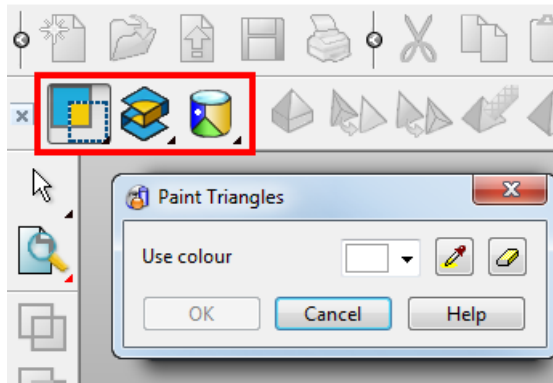

Select triangle area to distance (see page 20)

- 4 Pick the triangles using your chosen method. The triangles are painted in the colour indicated in the dialog.



- 5 If required, use  to remove the colour from the selected triangles in the mesh.

 *Selecting triangles and colouring them in this way is useful for dividing the mesh. Once the triangles are painted, use  to divide the mesh by colour.*



Morph mesh

This option is available only when using Delcam Designer or PowerSHAPE Pro.

Use the **Morph** flyout to change the shape of the mesh.



Use the following buttons on the flyout to change the shape of the selected mesh:

-  Use morph techniques to change the shape of the mesh (see page 29).
-  Morph triangle regions that are defined by planes (see page 30).
-  Morph triangle regions that are defined by curves (see page 38).

General morphing

- 1 Click the **General Morph**  button from the morphing flyout to display the **Morphing** dialog. This is the same as the dialog used with solid morphing.

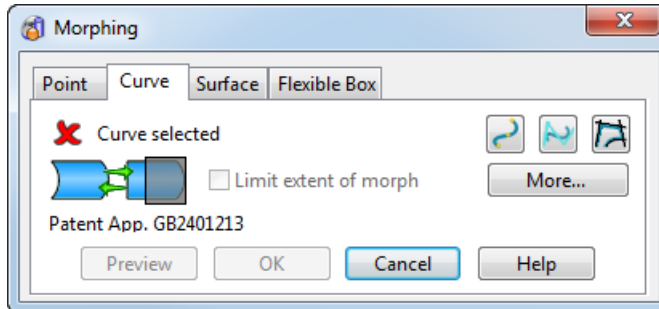

- 2 Use the tabs on the dialog to deform the active mesh into a different shape.

Morphing triangle regions defined by planes

You can transform one or more regions of the model. The regions are defined by planes.



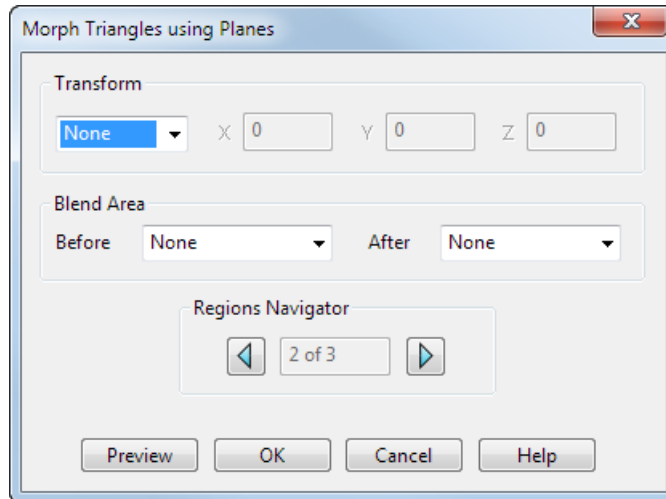

- 1 Click the **Morph using planes**  button from the morphing flyout to display the **Morph Triangles using Planes** dialog. The options that are displayed on the dialog reflect the **Transform** region that is selected.

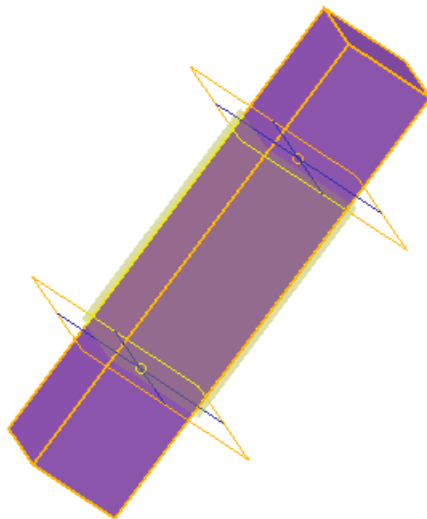

Two planes are used to define the regions of the model.



- 2 Adjust the position of a plane by double-clicking the plane and modifying the coordinates using the **Plane** dialog.
- 3 Select an option from the **Transform** list:
 - **None** — Select this option to have no blending between the central region and the outer regions. This is the default option.

- **Move** — Select this option to move the region between the two planes. Enter **X**, **Y**, and **Z** values to indicate the amount to move along the axes.
- **Rotate** — Select this option to rotate the region between the two planes. Enter a rotation **Angle**. Click the **Reposition**  button to define a new rotation origin.
- **Scale** — Select this option to increase or decrease the size of the region by entering a scale **Factor**. For example, to increase the size of the region by 20% enter a **Factor** of **1.2**. By default, **Factor** is applied in all directions. Use the **Lock**    buttons to suppress scaling in a specific axis.

Click the **Reposition**  to define a new position for the scale origin.

- **Offset** — Select this option to define the offset for the region. Enter an offset **Distance**.
- 4 Specify the **Blend Area** to be used **Before** and **After** the transform region. Additional planes are added to the model that define the blend region.

The following blend types are available:

- **None** is the default setting. No blend is created between the transformed region and the adjoining regions .

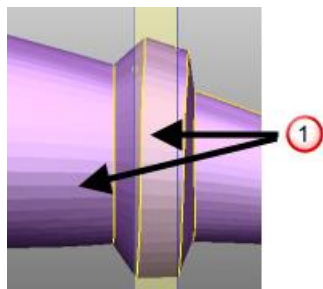

- **Smooth** creates a smooth curve between adjoining transform regions. The curve is tangential at both edges of the blend region.

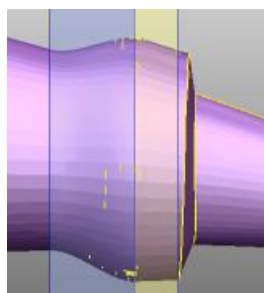

- **Linear** creates a straight-line blend between the two transform regions.

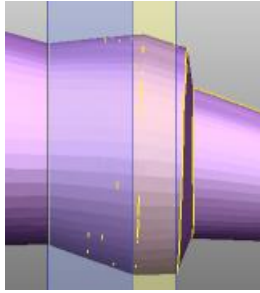

- **Smooth to Sharp** creates a smooth to sharp blend between the previous region and the current region. This creates a transition that uses a tangential curve next to the first transform region ②, and a linear blend next to the second transform region ③.

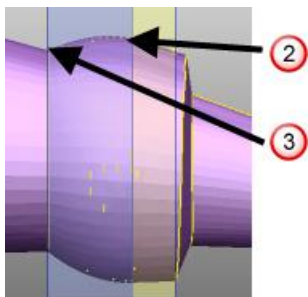

- **Sharp to Smooth** creates a sharp to smooth blend between the previous region and the current region. This creates a transition that uses a linear blend next to the first transform region ④, and a tangential curve next to the second transform region ⑤.

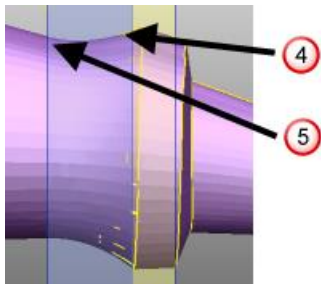

- 5 Use the buttons on the **Regions Navigator** to specify the region to be morphed.
- 6 Click **Preview** to view the morph.
- 7 Adjust the options as required.
- 8 Click **OK** to morph the region.

Example of morphing triangles using planar regions

- 1 Select the mesh.
- 2 Click the **Morph Using Planes**  button to display the **Morph Triangles by Planar Regions** dialog. Planes are used to indicate the different regions on the model.

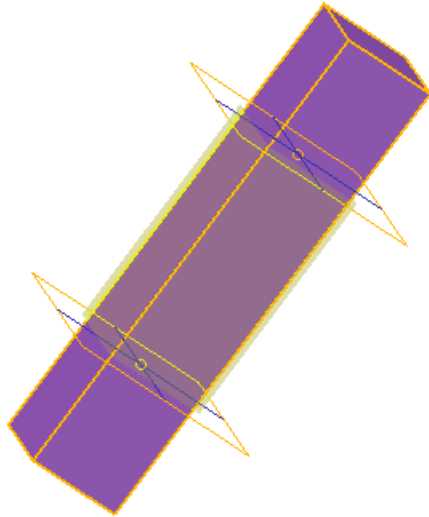

- 3 Double-click the top plane to display the **Plane** dialog.
- 4 Define the top plane as follows:
 - a Set **Z** to **30**.
 - b Click **OK** to move the plane.
- 5 Double-click the bottom plane to display the **Plane** dialog.
- 6 Define the bottom plane as follows:
 - a Set **Z** to **15**.

- b** Click **OK** to move the plane. The top and bottom planes now look like this:

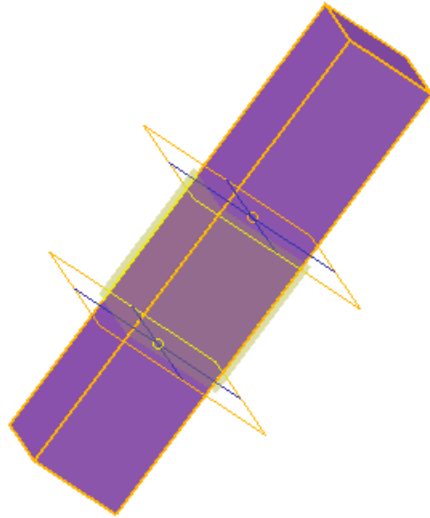

- 7** Define the **Transform** region as follows:

- a** Select **Rotate** from the list.
- b** Set the **Angle** to **10**.
- c** Click **Preview**.

The region between the two planes is rotated by 10°.

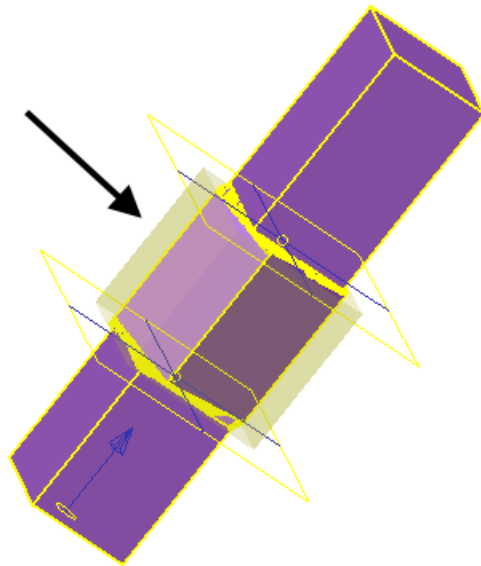



- 8** Specify the **Blend Area** as follows:

- a** Select **Smooth** from the **Before** list.
- b** Select **Linear** from the **After** list.
- c** Click **Preview**.

The bottom blend between **3** and **4** is created using the smooth algorithm

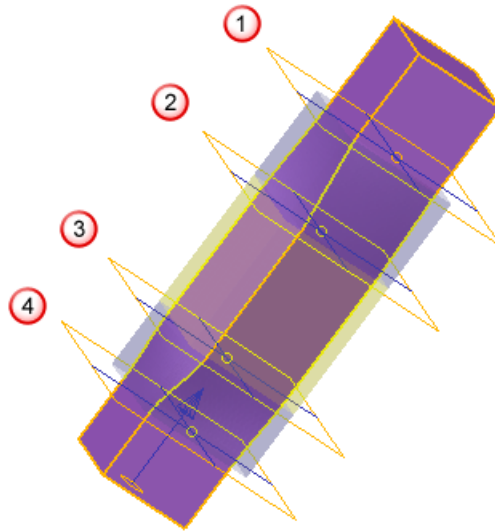
The top blend, between ① and ② is created using the linear algorithm.



9 Click the **Previous Region**  button to move to the bottom region, ⑤.

10 Create an offset region as follows:

- a Select **Offset** from the **Transform Region** list.
- b Set **Distance** to **1**.
- c Click **Preview**.

Region ⑤ is offset by 1.

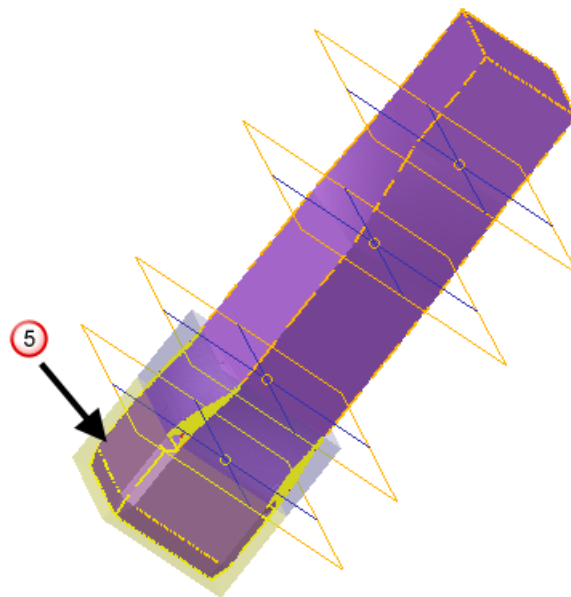

11 Press **Next Region**  button twice to move to the top region ⑥.

12 Create an offset region as follows:

- a Select **Offset** from the **Transform** list.

b Set **Distance** to **2**.

c Click **Preview**.

Region ⑥ is offset by 2.

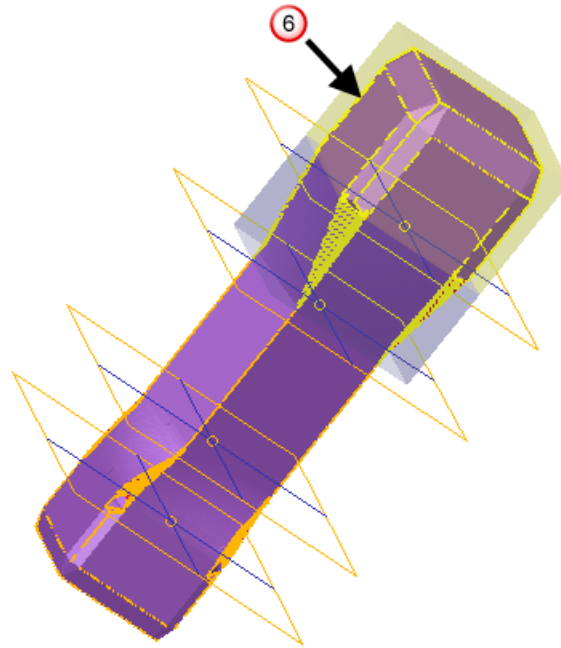

13 Click **OK** to modify the model as follows:

- Region ⑨ is rotated by 10° .
- Bottom blend ⑧ uses the smooth algorithm.
- Top blend ⑦ uses the linear algorithm.
- Bottom region ⑤ is offset by 1.

- Top region ⑥ is offset by 2.

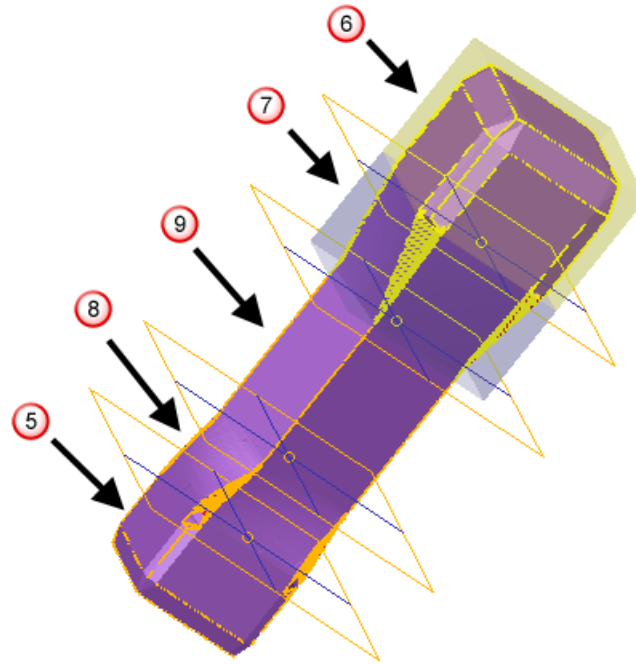

14 Complete further morphing as required.

Morphing triangle regions defined by curves

Morph regions on a model, using polygons to define the areas. Using polygons enables you to reshape up to three regions:

- within an inner curve
- outside an outer curve
- between the two curves

Using polygon regions

- 1 Create the inner and outer polygons (see page 39).
- 2 Use the following example to identify the regions and the curves on a mesh:

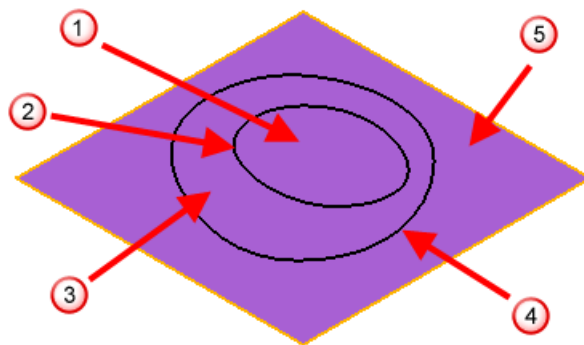

- ① Inner transform region.
- ② Inner curve.
- ③ Blend region.
- ④ Outer curve.
- ⑤ Outer transform region.

Using this method, you can move a single point and blend the move into the rest of the model. This technique is useful to counteract the sagging of the centre of a part after manufacture.

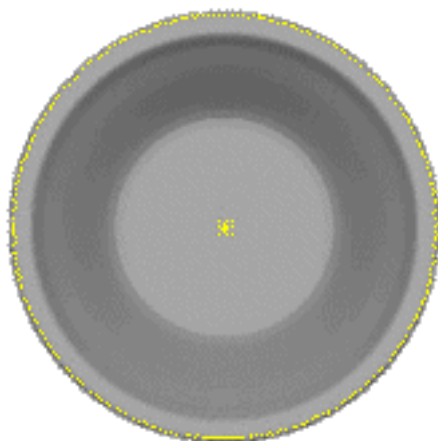

The example uses the centre of gravity to compensate for sag that occurs at the centre of a plate after it has been made. In this case the centre of the plate is moved by 2.0 and a smooth blend applied to the outer curve around the edge of the plate.

- 3 Morph the regions using the **Morph Triangles using Curves** dialog (see page 40).

Creating the inner and outer curves

Use one of the following methods to create the inner and outer curves:

- Sketch a curve on the model, using as many points as needed and click on the first point to close the curve.
- Select an open model; the boundary is used as the curve. You can use triangle or closed polyline models.





Use this option for the outer polygon, to create a curve around the boundary of the model. If you use this method, you can define an inner curve and blend from this to the edge of the model.



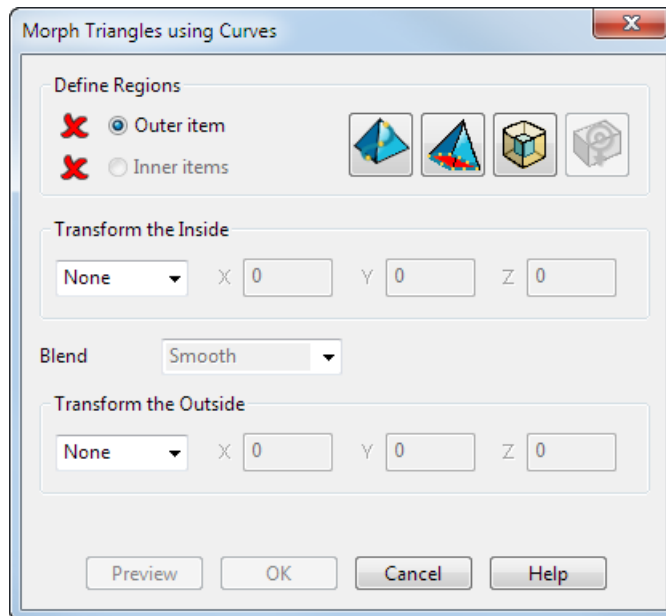

- Select a single point for the inner curve. This has the effect of creating a blend region from the model's centre of gravity to the outer curve.
- Use one of the options on the **Morph triangles using Curves** dialog (see page 40).

Morph Triangles using Curves dialog

- 1 Select a mesh.
- 2 Click the **Morph Using Curves**  button from the morphing flyout to display the **Morph Triangles using Curves** dialog.



- 3 If necessary, use the following buttons to create the inner and outer regions.
 - Click the **Snap to Mesh**  button to create a curve that is snapped to the mesh (see page 103).
 - Click the **Mesh Boundary**  button to create a curve at the mesh boundary (see page 106).
 - With a curve selected, click the **Offset**  button to offset the selected curve.
 - Click the **Centre of Gravity**  button to add a point at the centre of gravity.
- 4 Use **Ctrl + click** to select:
 - the **Outer Item**.
 - the **Inner Items**.The **X** changes to a **✓** for both options.
- 5 Select an option from the **Transform the Inside** list:
 - **None** — Select this option for no morphing of the inside region. This is the default.

- **Move** — Select this option to move the inside region. Enter **X**, **Y**, and **Z** values to indicate the amount to move along the axes.
- **Rotate** — Select this option to rotate the inner region. Enter a rotation **Angle**. Click the **Reposition**  button to define a new rotation origin.
- **Scale** — Select this option to increase or decrease the size of the region by entering a scale **Factor**. For example, to increase the size of the region by 20% enter a **Factor** of **1.2**. By default, **Factor** is be applied in all directions. Use the **Lock**    buttons to suppress scaling in a specific axis.
Click the **Reposition**  to define a new position for the scale origin.
- **Offset** — Select this option to define the offset for the region. Enter an offset **Distance**.

6 Select the type of blend.

The following blend types are available:

- **None** is the default setting. No blend is created between the transformed region and the adjoining regions .

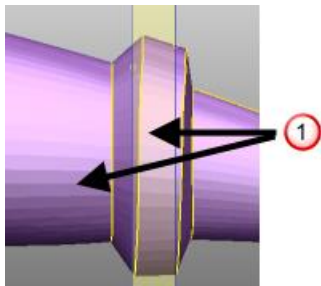

- **Smooth** creates a smooth curve between adjoining transform regions. The curve is tangential at both edges of the blend region.

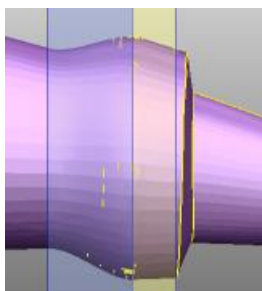

- **Linear** creates a straight-line blend between the two transform regions.

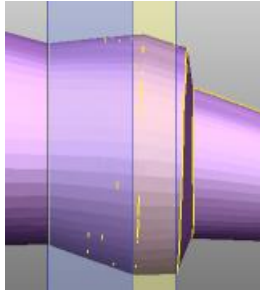

- **Smooth to Sharp** creates a smooth to sharp blend between the previous region and the current region. This creates a transition that uses a tangential curve next to the first transform region **2**, and a linear blend next to the second transform region **3**.

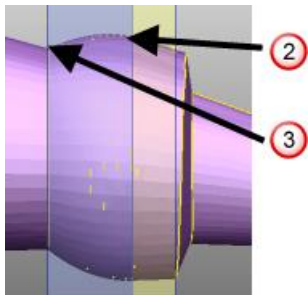



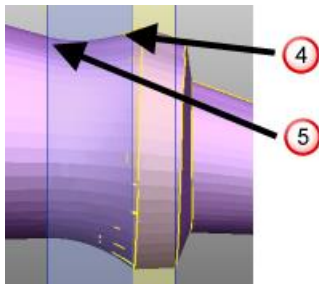

- **Sharp to Smooth** creates a sharp to smooth blend between the previous region and the current region. This creates a transition that uses a linear blend next to the first transform region **4**, and a tangential curve next to the second transform region **5**.



7 Select an option from the **Transform the Outside** list:

- **None** — Select this option for no morphing of the outside region. This is the default.
- **Move** — Select this option to move the outside region. Enter **X**, **Y**, and **Z** values to indicate the amount to move along the axes.
- **Rotate** — Select this option to rotate the outside region. Enter a rotation **Angle**. Click the **Reposition**  button to define a new rotation origin.

- **Scale** — Select this option to increase or decrease the size of the region by entering a scale **Factor**. For example, to increase the size of the region by 20% enter a **Factor** of **1.2**. By default, **Factor** is be applied in all directions. Use the **Lock**    buttons to suppress scaling in a specific axis.

Click the **Reposition**  to define a new position for the scale origin.

- **Offset** — Select this option to define the offset for the region. Enter an offset **Distance**.
- 8 Click **Preview** to view the morph.
 - 9 Click **OK** to morph the region.

Example of morphing triangle regions defined by curves



To see the effect of morphing, there must be sufficient triangles to allow the transform. The plane in the example below has been refined to increase the number of triangles.

- 1 Select the mesh.

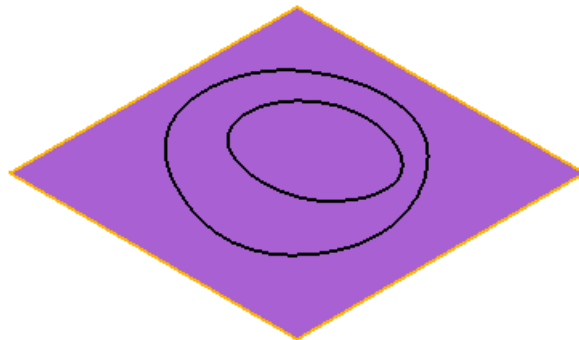

- 2 Click the **Morph Using Curves**  button to display the **Morph Triangle using Curves** dialog (see page 40).

- 3 Click  to select:

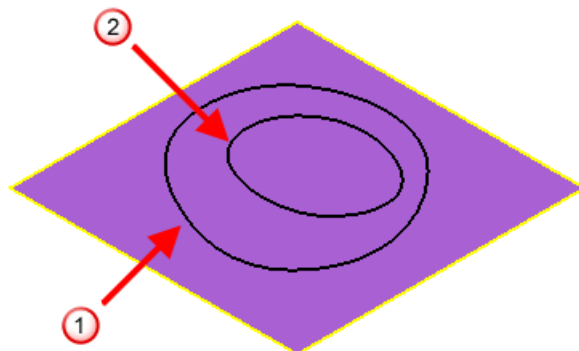

- ① Outer item
- ② Inner item
- 4 Select **Move** from the **Transform the inside** list.
- 5 Enter a **Z** value of **5**.
- 6 Select **Smooth** as the **Blend** type.
- 7 Click **Preview**.

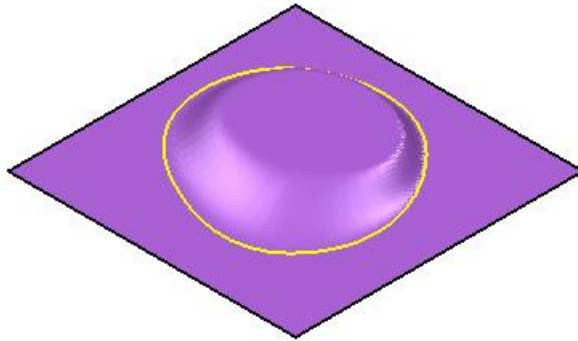

This shows the following changes:

- The inner region is moved upwards by 5.
 - Blend area (between the two contours) is created using the smoothing algorithm.
- 8 Select **Scale** from the **Transform the outside** list.
 - 9 Enter **1.5** as the scale **Factor**.
 - 10 Click the **Lock X**  button to lock the X axis.
 - 11 Click **Preview**.

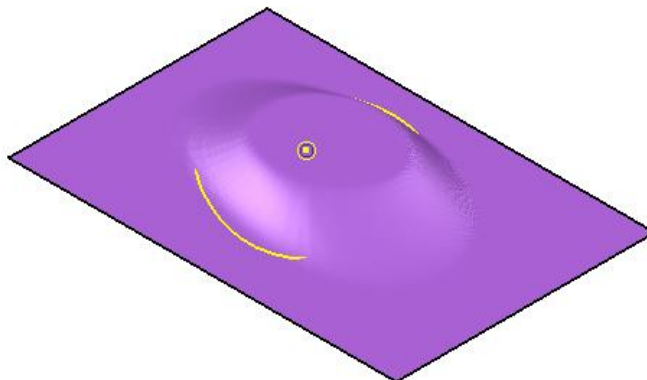

This shows that:

- The outer region is scaled by 1.5.
- The region is not scaled in the X direction.

Example of morphing triangle regions - contour and point



To see the effect of morphing, there must be sufficient triangles to allow the transform. The plane in the example below has been refined to increase the number of triangles.

- 1 Select the mesh.

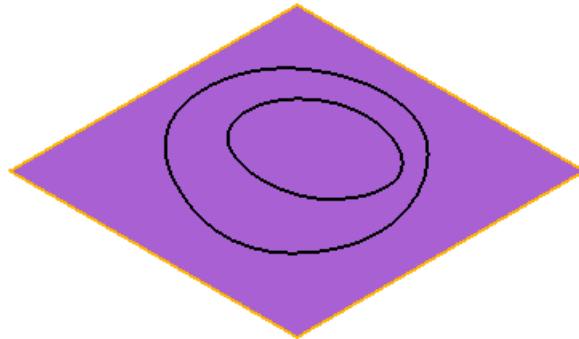

- 2 Click the **Morph Using Curves**  button to display the **Morph Triangle using Curves** dialog (see page 40).

- 3 Click the **Centre of Gravity**  button to highlight the centre of gravity.

The point is highlighted in blue **1**.

- 4 Use **Ctrl** + click to select:

- point **1**.
- outer contour **2**.

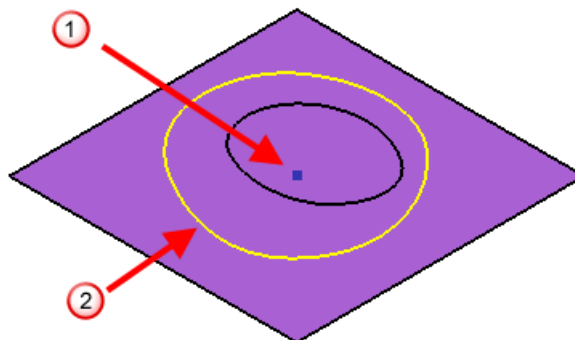

- 5 Select **Linear** from the **Blend** list.
- 6 Select **Move** from the **Transform the outside** list.
- 7 Enter a **Z** value of **10**.

- 8 Click **Preview** to display the model.

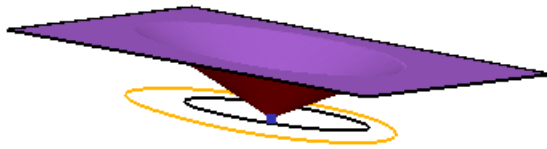



This shows that:

- The inner region (the point) does not move.
- The outer region is raised by 10.
- The blend area is created using a linear blend.

Segment mesh

Use the segmentation functionality to identify the different regions of a mesh, and then create primitive or general surfaces to fit those regions.

- Select an option from the **Segmentation**  flyout to segment and fit surfaces to a mesh. Use the following buttons to segment the mesh:
 -  **Automatically Segment** (see page 47)
 -  **Manually Segment** (see page 54)
- Segmentation options are specified using the **Mesh** page of the **Options** dialog.

Automatically segment meshes

Use automatic segmentation to quickly segment and fit multiple surfaces to a mesh.

- 1 Select the mesh.



- 2 Select **Automatic segmentation**  from the segmentation flyout













- 3 Use the following options of the **Segment Mesh** dialog to control the segmentation process:

- Use the slider **1** or enter a value **2** to edit the **Similarity angle**.



Lower similarity angles are useful to separate regions of high curvature on smooth meshes. Higher similarity angles are suited for coarser meshes with stronger discontinuities.

- Enter a value for the surface matching tolerance **3**.
- Select which primitive geometries to use for segmentation, from the **Primitive Types** list **4**.
- Click  to display the **Edit Extension** dialog (see page 51).

- Click  followed by preview to **Reclaim regions** which have had primitives fitted to them.
- Click  to display the **Segmentation Settings** dialog (see page 51).
- Click  to toggle between generating surfaces or solids.
- Use the Fit flyout  to select the fit direction:
 -  **Fit inside** — Select this option so that the primitive surface is fitted to lie just below the inside of the mesh.
 -  **Fit through middle** — Select this option so that the primitive surface is fitted as close as possible to the centre of the mesh.
 -  **Fit outside** — Select this option so that the primitive surface is fitted to lie just above the outside of the mesh.
- Click  to display the **Manually segment mesh** toolbar (see page 54).
- Select **Blank applied items**  to automatically blank any applied surfaces or solids.

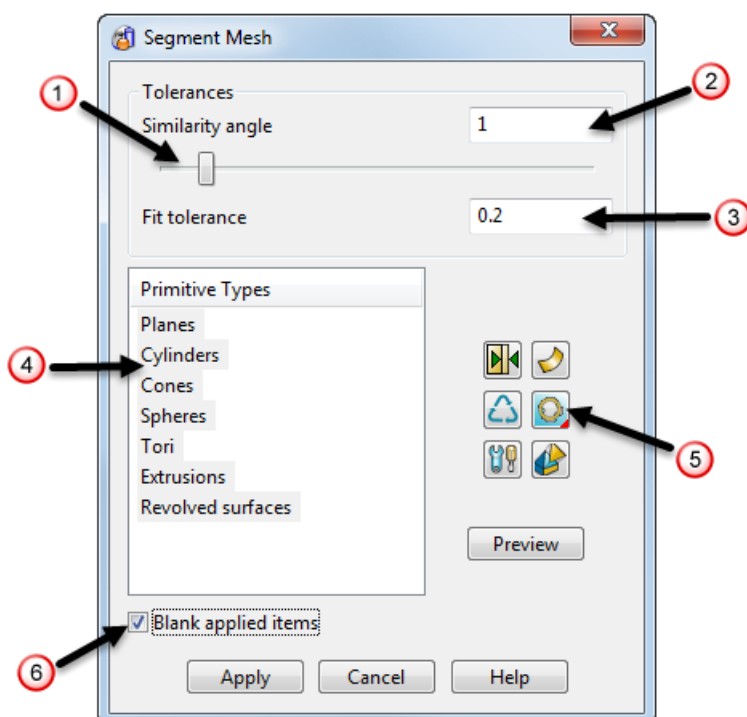

- 4 Click **Preview** to display a preview of the generated items.

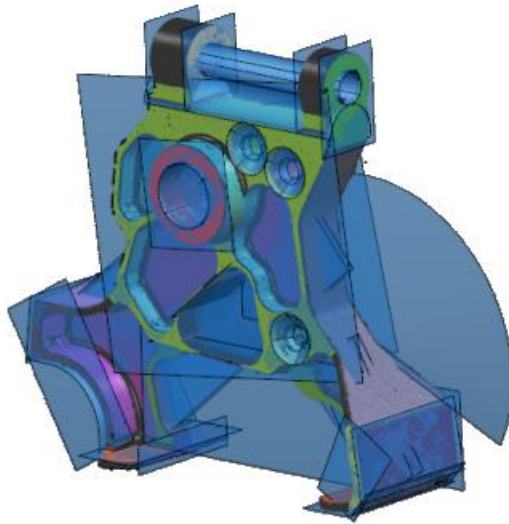

Move the mouse over the generated item to display the fit tolerance.



*If you change any of the options in the dialog you must click **Preview** again to update the preview.*

- 5 Select the generated items you want to keep using , and click **Apply** to create the items.

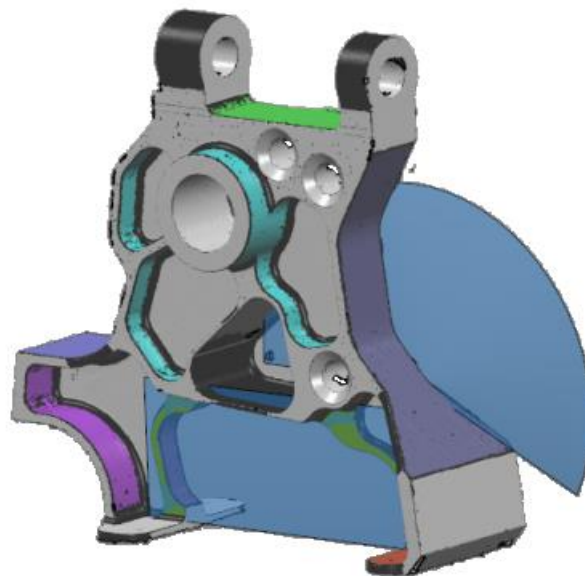

*Using  on the item performs the same action as clicking **Apply**.*

- 6 To create additional items that were not previously detected:
 - a Change the **Similarity angle** from the **Segment mesh** dialog.

- b** Click **Preview**.
 - c** Select the items and click **Apply**.
- 7** Close the dialog and blank the mesh, leaving the newly created items.

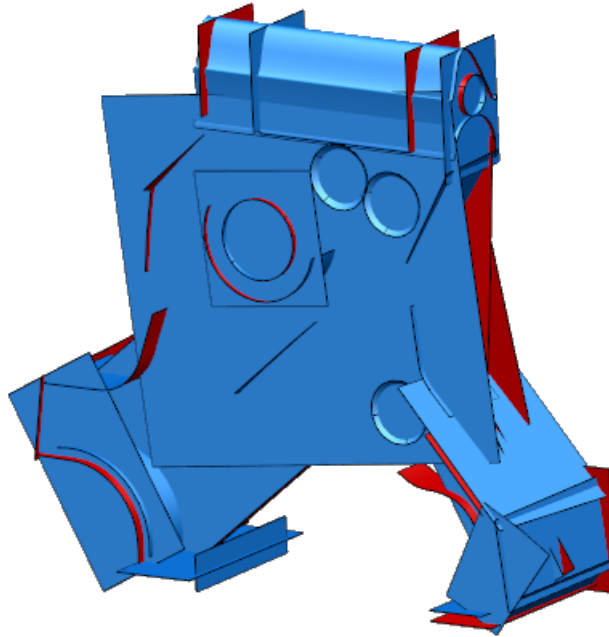

Previously selected surfaces are remembered if you exit and then re-enter the segmenter for the same mesh.

If any of the surfaces are deleted before returning to the segmenter, their regions are freed.

If you undo, redo, or modify the mesh in any way, the persisted data will most likely be lost. For these circumstances the segmenter won't be able to remember which surfaces it produced.

Edit Extension dialog

The **Edit Extension** dialog enables you to edit extension distances of surfaces fitted to mesh models.

To edit the extension distances of fit surfaces:

- 1 Click the **Edit extension distances**  button on the **Segment Mesh** dialog. The **Edit Extension** dialog is displayed:

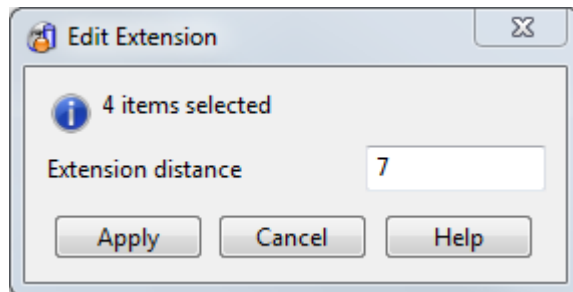

- 2 Select the surfaces you want to edit. Left-click to select a single surface. Hold down the **Shift** key and left-click to select multiple surfaces or drag a box over your selection.
- 3 Enter a new **Extension distance** value to define the distance by which the surfaces are extended beyond the edge of the regions.
- 4 Click **Apply** to update the extension distance of the selected surfaces.
- 5 Click **Cancel** to close the dialog. This discards any unapplied changes.



*This is in contrast to editing extension distances using the options on the **Segmentation Settings** dialog (see page 51), which applies the edit to all surfaces or solids in your model.*

Segmentation Settings dialog

The **Segmentation Settings** dialog enables you to control common segmentation settings for manual and automatic segmentation operations.

To change the settings for manual and automatic segmentation operations:

- 1 Click the **Segmentation settings**  button on the **Segment Mesh** dialog. The **Segmentation Settings** dialog is displayed.

2 Use the **General** tab to:

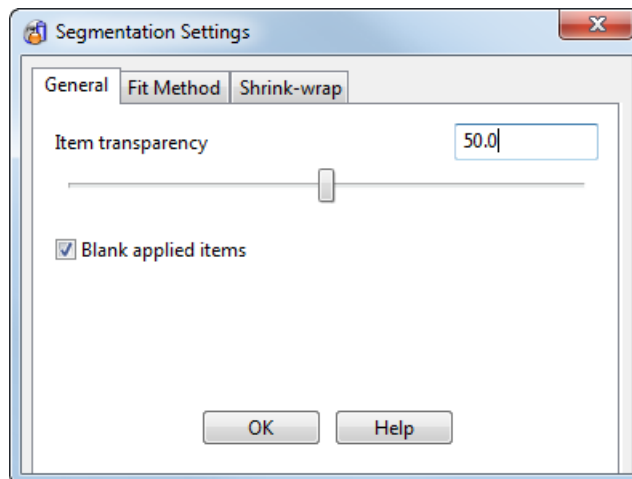

- Click and drag the **Item transparency** slider to change the transparency of the fit surfaces when previewed.
- Select **Blank applied items** to automatically blank any applied surfaces. If deselected, the transparency setting chosen above will determine the appearance of applied surfaces.



*This check box is also available on the **Segment Mesh** dialog.*

3 Use the **Fit Method** tab to:

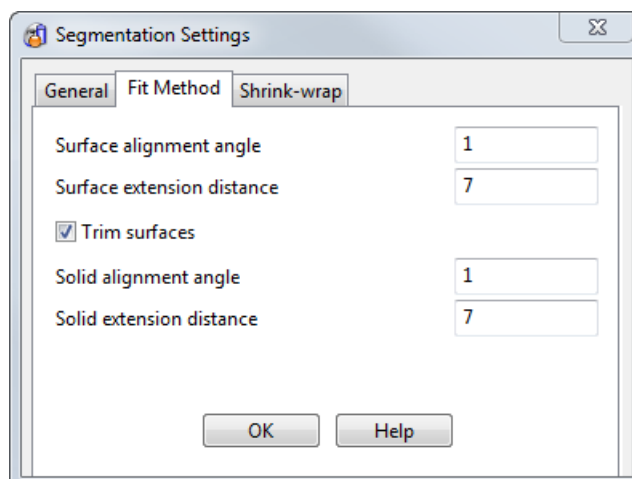

- Edit the **Surface alignment angle** to define the tolerance for aligning primitive surfaces with a principal plane.
- Edit the **Surface extension distance** to define the distance by which a primitive surface is extended beyond the edge of its region.



*This is applied to all surfaces in the model, in contrast to the **Edit Extension** dialog (see page 51) which requires a selection of surfaces.*

- Select the **Trim surfaces** option to create trimmed surfaces when segmenting.
- Repeat for **Solid alignment angle** and **Solid extension distance** as required.



*These options are also found in **Tools > Options > Object > Mesh** and can now be changed independently for surfaces and solids.*

4 To use the **Shrink-wrap** tab:

- Click the **Manually segment mesh**  button to display the options:

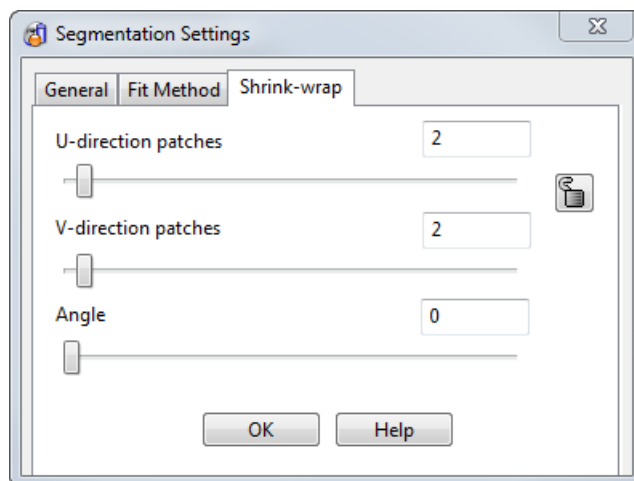

- Click and drag the **U-direction patches** slider, or enter an exact value, to define the number of U direction control points used to generate the surface curves in 2D space.
- Click and drag the **V-direction patches** slider, or enter an exact value, to define the number of V direction control points used to generate the surface curves in 2D space.
- Click  to edit the number of control points in both directions equally.
- Click and drag the **Angle** slider to manually orientate the shrink-wrap surface.



*These options are the same as those on the **Shrink-wrap mesh** dialog, accessed on the **Mesh Edit** toolbar.*



*The **Segmentation settings**  button is now common to the **Automatic** and **Manual** segmentation options.*

Manually segment meshes

Use manual segmentation to individually segment and fit surfaces to a mesh.

- 1 Select the mesh.



- 2 Select **Manual segmentation**  from the segmentation flyout .



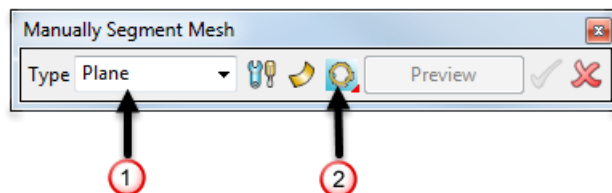

- 3 Use the following options of the **Manually Segment Mesh** toolbar to control the segmentation:



- Use the **Type** drop-down list **1** to select the item type to fit.
 - Plane** — surface only
 - Cylinder**
 - Cone**
 - Sphere**
 - Torus**
 - Extrusion**

Revolution — surface only

Shrink-wrap — surface only

- Click  to display the **Segmentation Settings** dialog (see page 51).
- Click  to toggle between generating surfaces or solids.
- Use the Fit flyout  to select the fit direction:

 **Fit inside** — Select this option so that the primitive surface is fitted to lie just below the inside of the mesh.

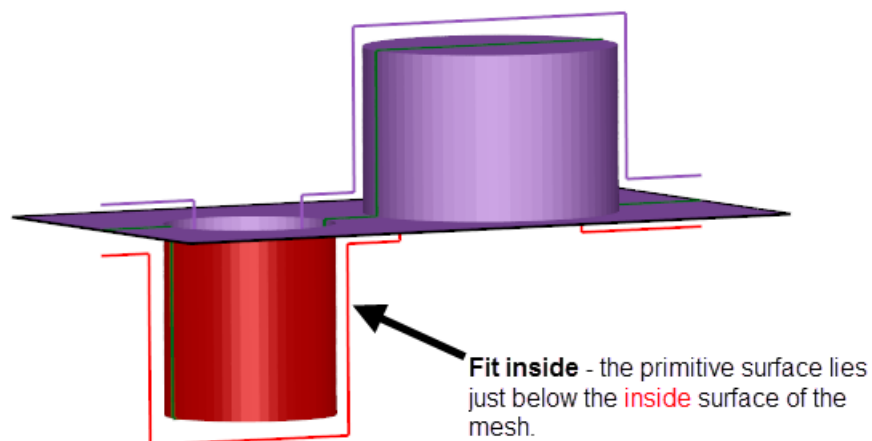

This example is exaggerated to highlight the effects of different fit directions.

 **Fit through middle** — Select this option so that the primitive surface is fitted as close as possible to the centre of the mesh.

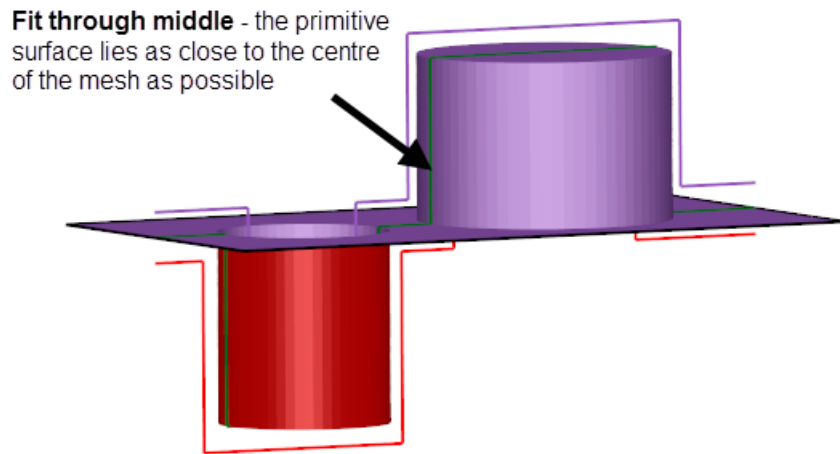

This example is exaggerated to highlight the effects of different fit directions.

 **Fit outside** — Select this option so that the primitive surface is fitted to lie just above the outside of the mesh.

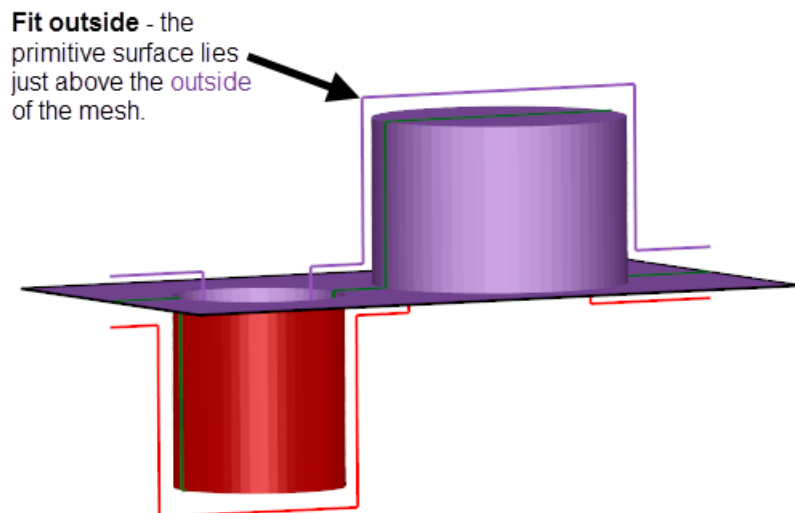

This example is exaggerated to highlight the effects of different fit directions.

- 1 Select an area of triangles on the mesh using the triangle selection tools.

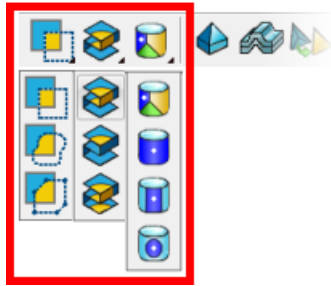



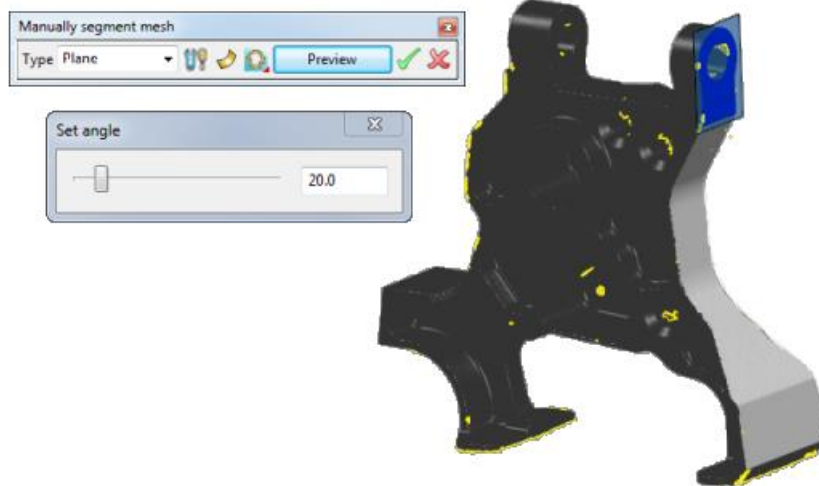

- 2 Click **Preview** to display a preview of the generated items on the model.

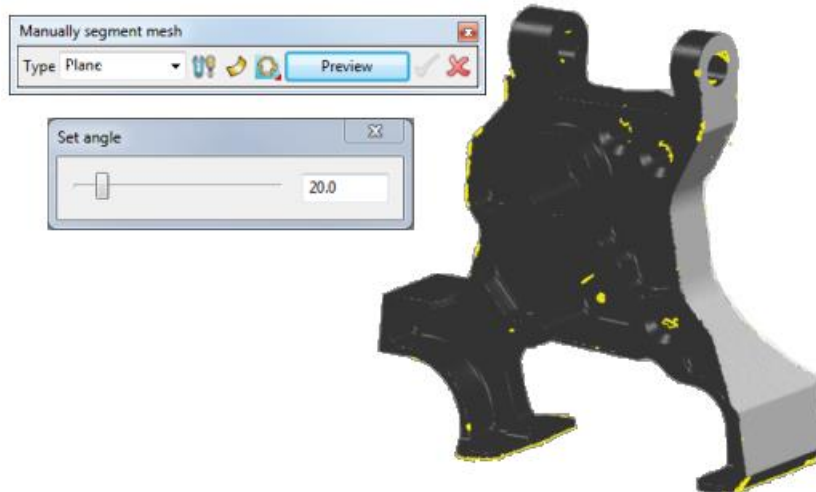

Move the mouse over the generated item to display the fit tolerance.

- 3 Click to accept and blank the item. Alternatively click to cancel the preview, and close the dialog.



 Using  on the item performs the same action as clicking .

- 4 Close the dialog to view the newly created items.



 *Previously selected surfaces are remembered if you exit and then re-enter the segmenter for the same mesh.*

If any of the surfaces are deleted before returning to the segmenter, their regions are freed.

If you undo, redo, or modify the mesh in any way, the persisted data will most likely be lost. For these circumstances the segmenter won't be able to remember which surfaces it produced.

Shrink-wrap a surface onto a mesh

You can generate a non-primitive surface and automatically trim it to fit a mesh using **Shrink-wrap**.

- 1 Select the mesh to display the **Mesh Edit** toolbar.
- 2 Use one of the selection tools to select the triangles to be shrink-wrapped.

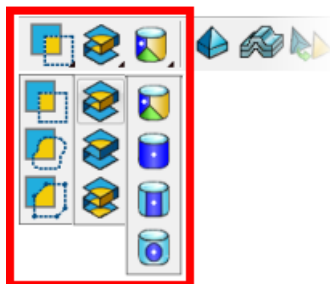

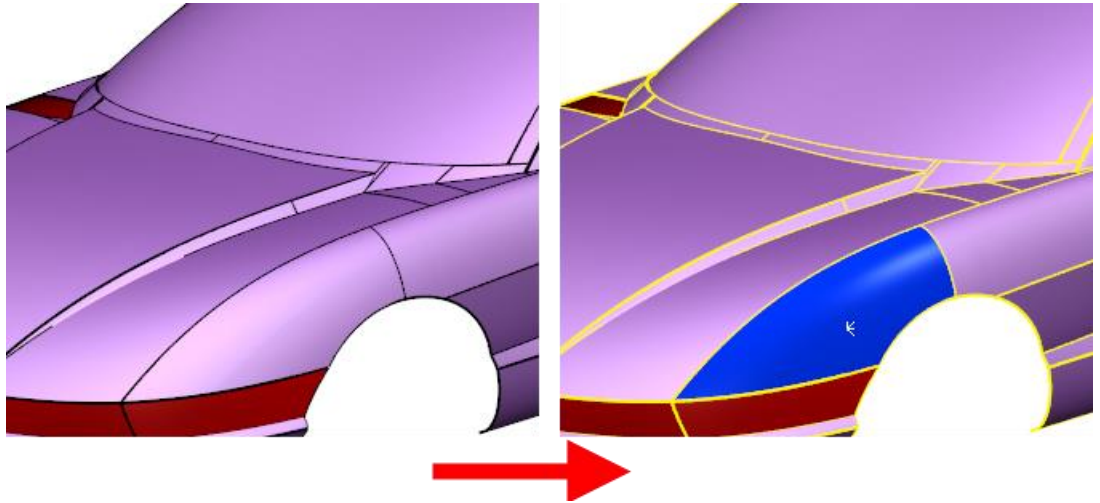

3 Select the triangles to shrink wrap



4 Click **Shrink-wrap a surface onto the selected mesh** on the **Mesh Edit** toolbar.



5 Use the following options on the **Shrink-wrap Mesh** dialog:

- **U-direction patches** — use the slider, or enter an exact value to define the number of U direction control points used to generate the surface curves in 2D space.
- **V-direction patches** — use the slider, or enter an exact value to define the number of V direction control points used to generate the surface curves in 2D space.
- Click  to edit the number of control points in both parametric directions symmetrically **3**.
-  *For trivial meshes with simple curvature, fewer control points are needed. For non-trivial meshes with complex curvature, more control points are needed.*
- **Angle** — use the slider to manually orientate the shrink-wrap surface.

Before alignment

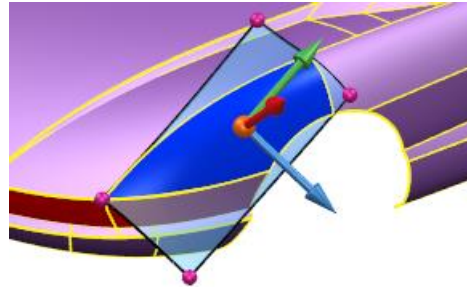

After alignment

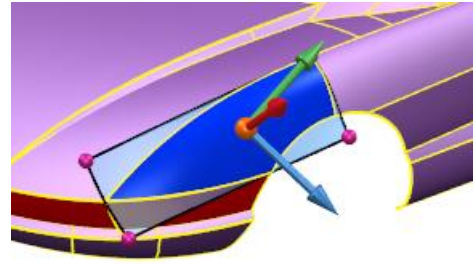

- You can also click and drag the graphic handles **1** to rotate the surface around the temporary workplane **2**.

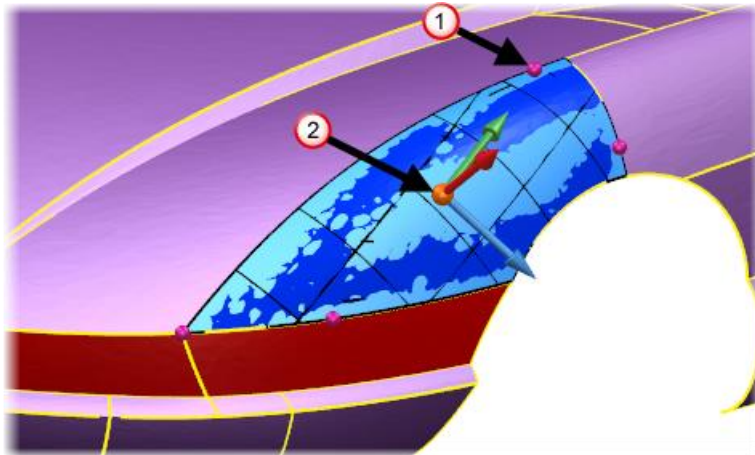

- A preview **3** is displayed that shows the lateral and longitudinal directions for the re-aligned surface.

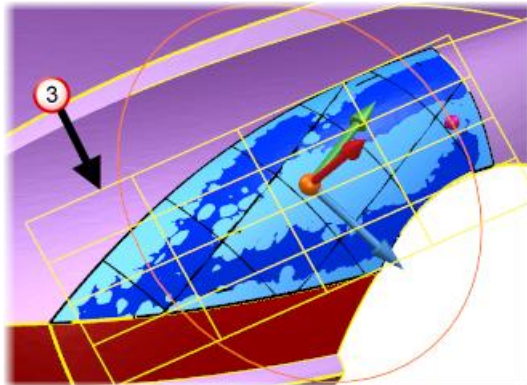

- **Preview** — click to get a preview of the surface.
- **OK** — click to create the surface and close the dialog.

- **Cancel** — click to close the dialog with no changes.

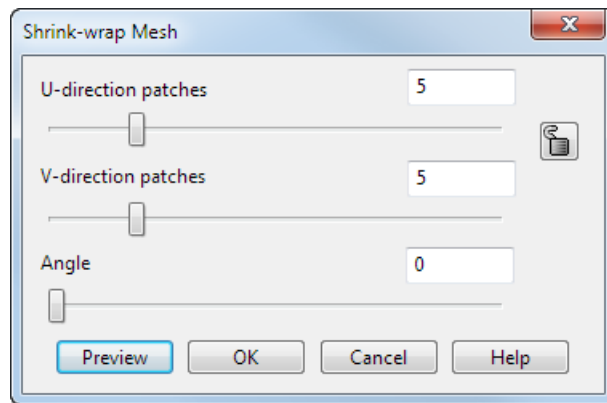

- 1 Click **OK** to create the surface.

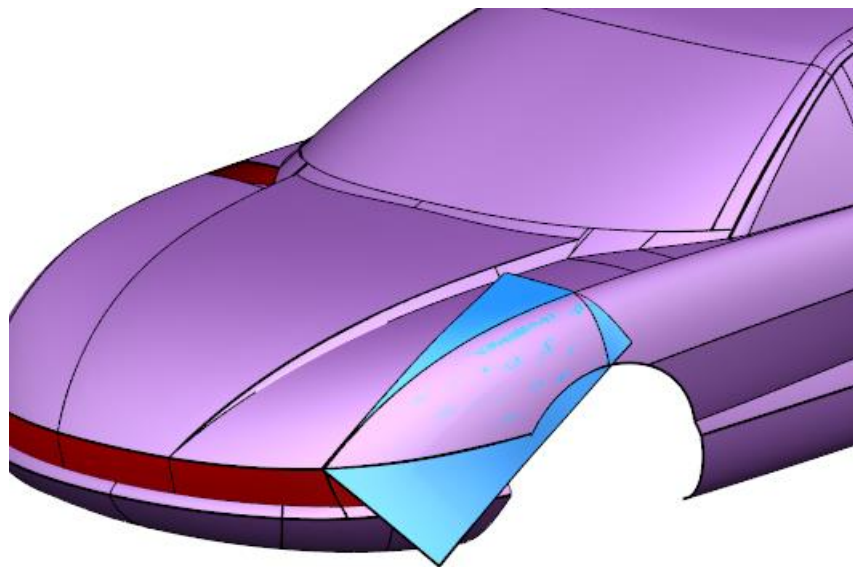

Dividing a mesh

Use the options on the **Divide mesh** flyout to divide the mesh:

- Divide mesh
- Divide mesh by colour
- Divide mesh by selection

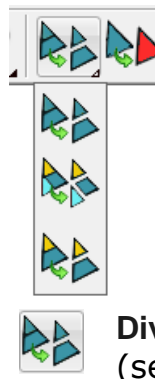

Divide mesh
(see page 62)



Divide mesh by colour (see page 62)



Divide mesh by selection (see page 64)

Divide mesh

Use this option to separate meshes.

- 1 Select a mesh to display the **Mesh Editing** toolbar.

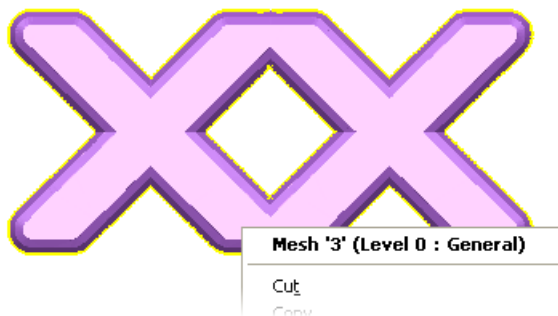

- 2 Click the **Divide Mesh**  button on the **Mesh Edit** toolbar. The mesh is divided to create multiple meshes.

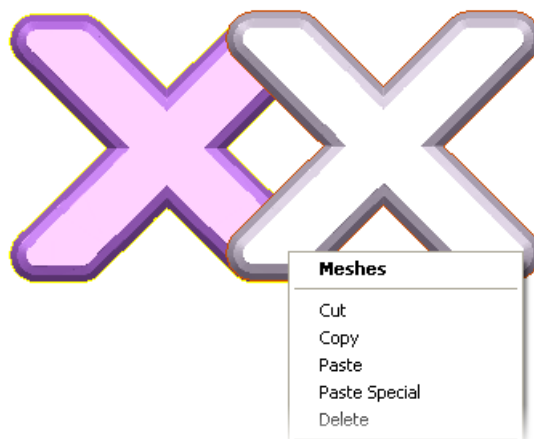

***Divide Mesh** asks for confirmation before dividing a mesh that consists of more than ten unconnected regions.*

Divide mesh by colour

Use this option to separate meshes by colour.

- 1 Select a mesh to display the **Mesh Editing** toolbar.

- Use **Paint Triangles** to paint the area of the mesh that you wish to separate.



- With the mesh selected, click the **Divide by Colour**  button. The mesh is divided into three separate, selected meshes.

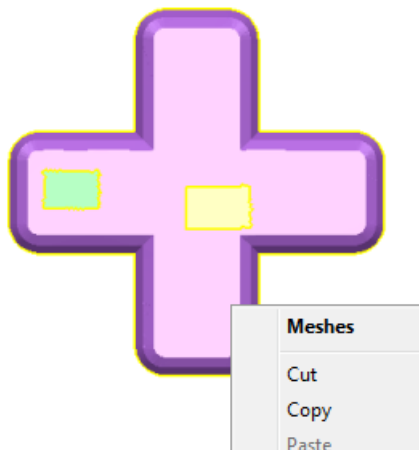

- Click away from the model. The boundary on the coloured areas changes to black.
- Right click each coloured area to check that the mesh has been separated.

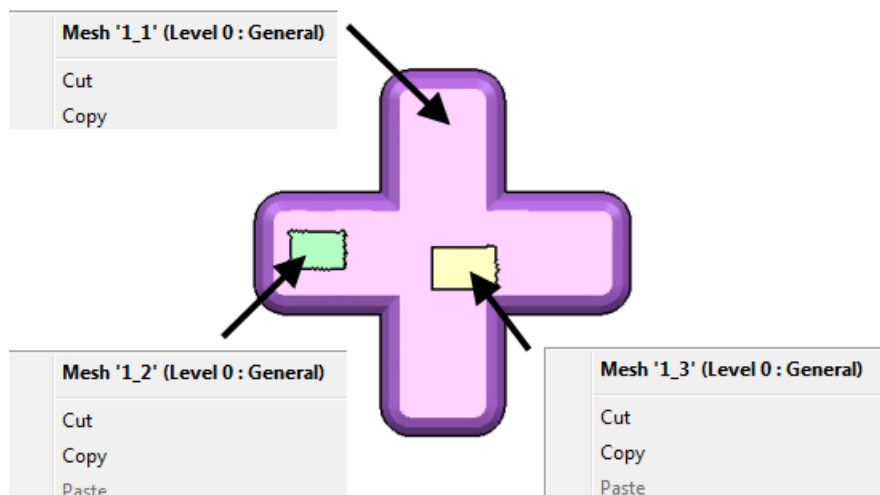



Divide mesh by selection

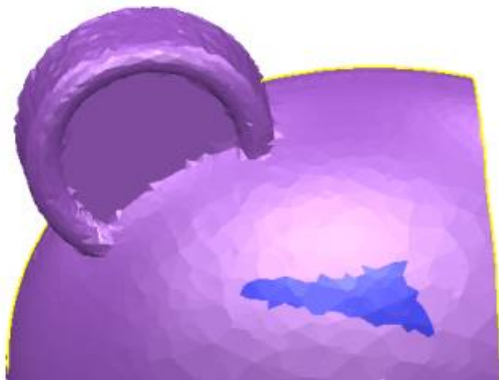

This functionality is available only in PowerSHAPE Pro.

- 1 Select a mesh to display the **Mesh Editing** toolbar.
- 2 Use one of the selection methods to select the area of the mesh that you wish to separate.



- 3 Click the **Divide by Selection**  button. The mesh is divided into two separate, selected meshes.

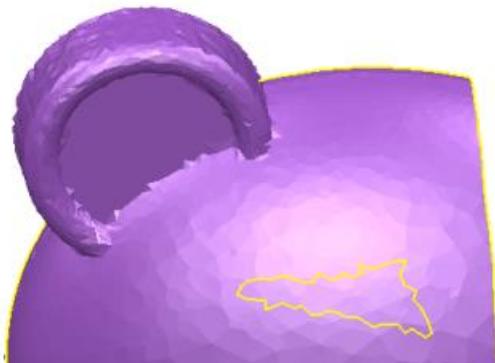

- 4 Right-click each area to check that the mesh has been separated.

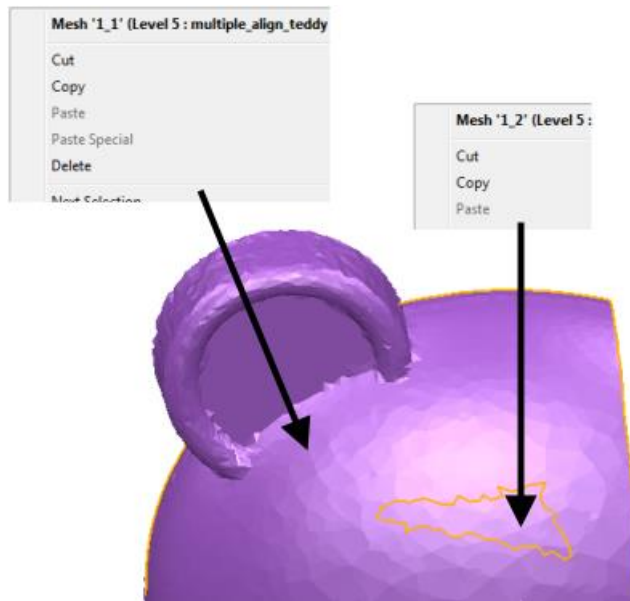

Reverse a mesh

Use this option to reverse the direction of the triangles in the selected mesh.

- 1 Select one or more meshes to display the **Mesh Edit** toolbar.



- 2 Click the **Reverse Mesh**  button on the **Mesh Edit** toolbar.

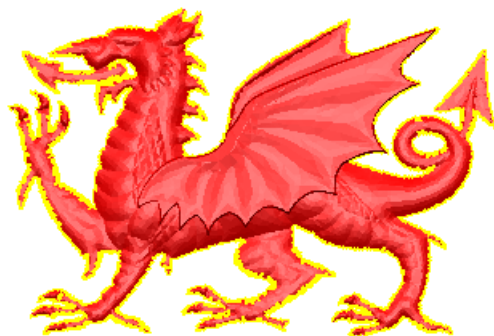

Fixing faults in a mesh

This option is available only when using Delcam Designer or PowerSHAPE Pro.

Fix faults in a mesh using the **Mesh Doctor**. The following are classed as faults:

- small and thin triangles
- bad aspect ratio
- badly connected triangles
- overlaps
- gaps
- holes
- intersecting triangles

These problems need to be corrected to ensure that the mesh is as accurate and smooth as possible.

For further details, see:

- Mesh Doctor flyout (see page 66)
- Using the Mesh Doctor to fix the mesh (see page 68)
- Mesh Doctor dialog (see page 69)
- List of fault options (see page 71)

Mesh Doctor flyout

Use the options on the **Mesh Doctor** flyout to check and fix a specific fault type:



- 1 Click on one of the following buttons to fix a particular type of fault.



Mesh Doctor — Click this button to open the **Mesh Doctor** (see page 68)



Bad Connections — Click this button to fix bad connections



Open Boundaries — Click this button to fix open boundaries.



Aspect Ratio — Click this button to fix triangles with bad aspect ratio by swapping the edges with a neighbouring triangle.



Small Triangles — Click this button to fix small triangles.



Intersections — Click this button to fix intersecting triangles.



Overlaps — Click this button to fix overlapping triangles.



Status — Click this button to display a summary of the faults in the mesh.

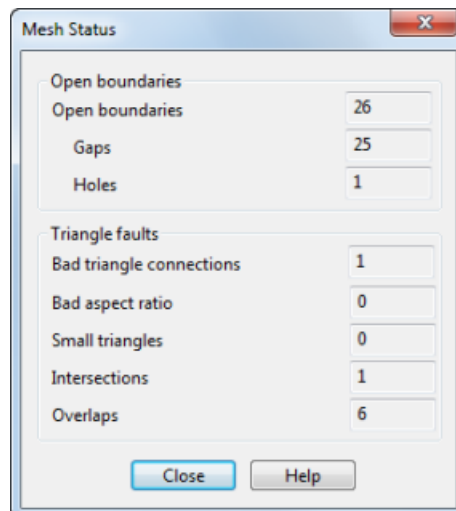

- 2 Use the Mesh Doctor dialog to fix the mesh (see page 69).



If you click  the **Mesh Doctor** detects and fixes all types of faults. If you click other options on the Mesh Doctor flyout, the Mesh Doctor identifies and fixes only the fault type that you have selected.

Using the Mesh Doctor to fix the mesh

Mesh Doctor works in a similar way to **Solid Doctor**; it finds faults and tries to fix them.

- 1 Select one or more meshes to display the **Mesh Edit** toolbar.

- 2 Click the **Mesh Doctor**  button on the Mesh Edit toolbar to display the **Mesh Doctor** dialog (see page 69).

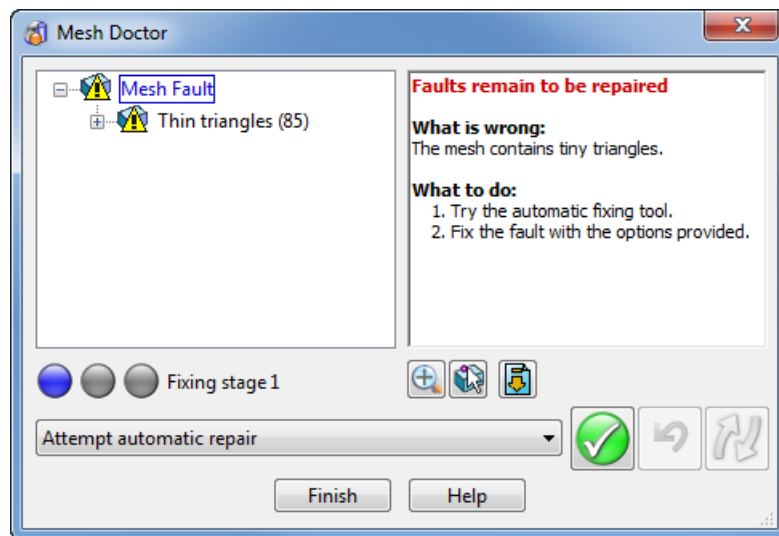



The **Mesh Doctor** checks faults in the following order:

- a Badly connected triangles
- b Gaps
- c Holes
- d Small and thin triangles
- e Bad aspect ratio triangles
- f Intersections
- g Overlaps

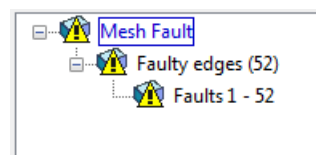
The faults are listed in the fault tree and displayed in pink on the model. You must fix faults in the order they are listed. If there are more than fifty faults of the same type, the Mesh Doctor merges them into a single superfault in the fault tree.



- 3 Select the first branch in the fault tree. The **Mesh Doctor** must fix this type of fault first.
- 4 Ensure that **Attempt automatic repair** is selected.

- 5 Click the **Process**  button to process the repair. On the mesh, the faults that have been repaired and the corresponding fault labels turn green. **Fault has been repaired** is displayed in green at the top of the information window in the dialog.
- 6 Click the **Re-check**  button to re-check the model. Only faults that still need fixing are displayed. Comparing this to the original shows that many of the faults have been fixed using the automatic repair feature.
- 7 If there are still faults, try using other options on the fault repair drop-down list. Fix all the faults of one type before fixing other types of fault.
- 8 When all faults are fixed, click **Finish**.

Mesh Doctor dialog

Use the dialog to fix all the faults in a mesh. Resize the dialog as required, so that you can see the fault list.

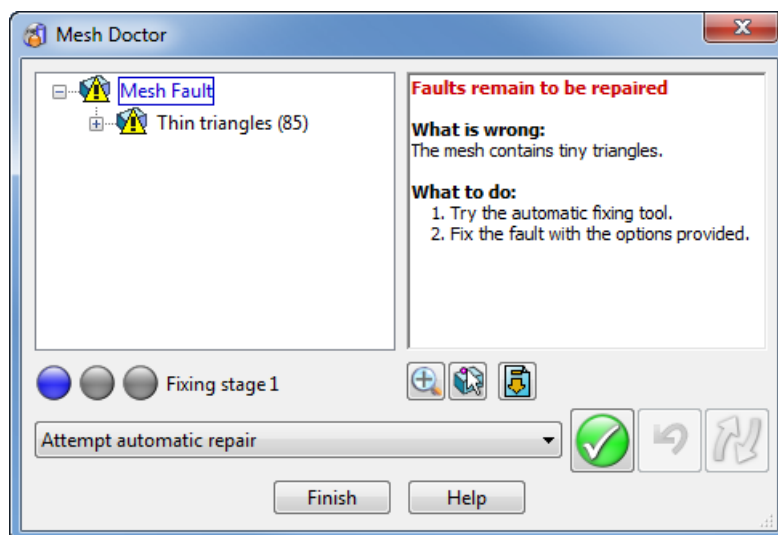

The **Fault Tree** is displayed in the left panel of the dialog and lists the faults in the mesh.

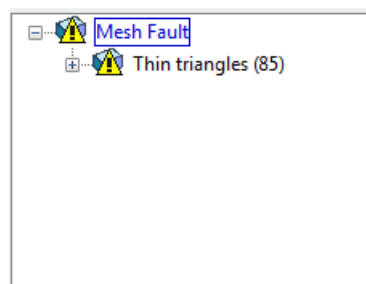

You can select faults in the Fault Tree or the model window:

- If you select a fault in the tree, it is highlighted in the model.

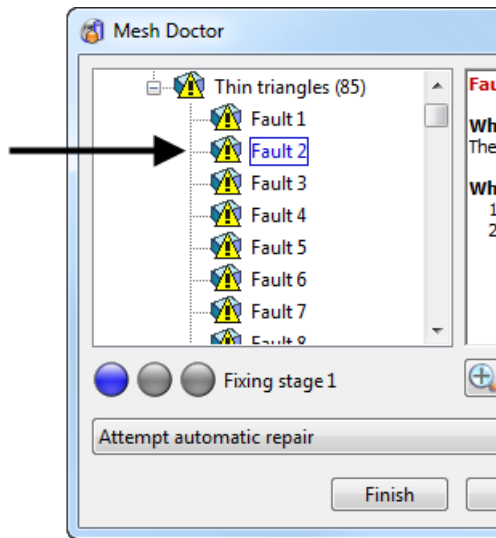

- If you select a fault label or fault annotation in the mesh, it is highlighted in the tree.

Fault Information for the selected fault is displayed in the right panel of the dialog.

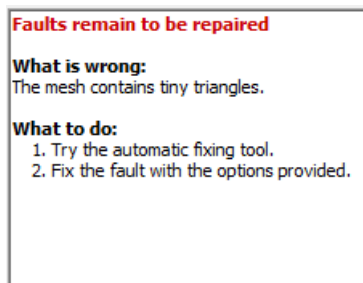

The following fault information is provided:

- **What is wrong:** shows a description of the fault.
- **What to do:** gives a suggested repair procedure.
- **Failed repair operations** lists the fixing operation that failed.

Fixing stage graphics show the progress on fixing faults.

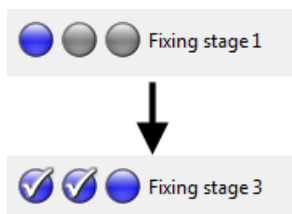

Viewing and saving the model:

- Click the **Zoom**  button to zoom into the selected fault. Zoom out to view the whole solid.
- Toggle the fault view:

 **Selected Fault** — Display this icon to highlight the selected fault only.

 **All Faults** — Display this icon to highlight all the faults.

- Click the **Save**  button to save the mesh with a different filename.

Repair Options — Select a repair option from the list of available repair operations. The default option is **Attempt automatic repair**. Click the drop-down list to see the see list of repair options (see page 71).

 **Process** — Click this button to apply the repair option to the selected faults.

 **Undo** — Click this button to undo each repair operation.

 **Re-check** — Click this button to re-check the mesh for faults.

Finish — Click this button to close the dialog and re-check for faults. If faults are found the **Faulty Mesh Query** dialog is displayed.

List of fault options

This lists the repair options displayed in the **Mesh Doctor** dialog (see page 69). The repair options relevant to the selected fault are displayed in the **Repair Options** drop-down list.

Repair option	Action
Attempt automatic repair	Try to resolve the fault automatically.
Fill hole with curvature cap Fill gap with new triangle	Fill the hole with a curvature matching cap.
Fill hole with planar cap	Fill the hole with a planar cap.
Mark hole boundary with curve for manual fixing	Create a curve around the fault triangles, holes, or gaps.
Ignore intentional large hole Ignore triangles with bad aspect ratio Ignore thin triangles Ignore small triangles	Ignore this fault.
Delete triangles	Delete all triangles that form the fault.

Delete smallest triangle in this fault	Delete the smallest triangle within this fault.
Link boundaries across gap Close gaps by stitching across open boundaries	Stitch the gap boundaries of this fault.
Fix by merging nodes that form small triangles Fix by merging nodes	Merge (stitch) nodes of this fault.
Remove thin triangles and stitch across gap	Delete the triangles of this fault and stitch across the created gap.

Fill holes

This option is available only when using Delcam Designer or PowerSHAPE Pro.

Click the **Fill Holes**  button to fill holes in the model by selecting the open boundaries.

If the hole to be filled covers an area of different curvature, split the hole into smaller regions, and fill them separately. This allows more complicated holes to be fixed without the need for full manual triangle-editing. After selecting a hole to fill, you can pick two points on the boundary to split the hole into two regions. If the wrong side is highlighted by default, click to select the region that you want to fill.

For example, using the [plate.stl](#) example file supplied with PowerSHAPE, fill the hole in two parts, filling the flat area with a planar cap, and the curved area with a curvature cap.



1 Select a mesh to display the **Mesh Edit** toolbar.

2 Click the **Fill Holes**  button to open the **Fill Holes** dialog.

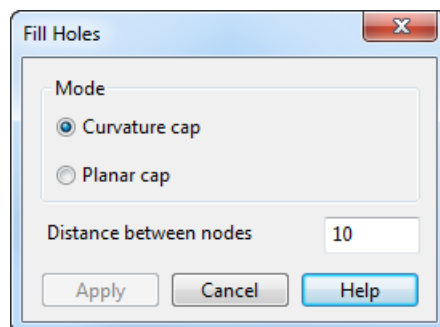

3 Select holes to fill in one of the following ways:

▪ **Box selection:**

Use the following key and box selection techniques to select holes to be filled in a selected mesh:

Shift and box selection to add the selection to the set of selected holes.

Ctrl and box selection to invert the selection status of holes intersected by the box.

Box selection without **Ctrl** or **Shift** adds holes intersected by the box to the set of selection holes. All holes that are not intersected by the box are removed from the selection.

▪ **Boundary selection:**

(a) Select the hole by clicking its boundary ①. The selected boundary turns blue.

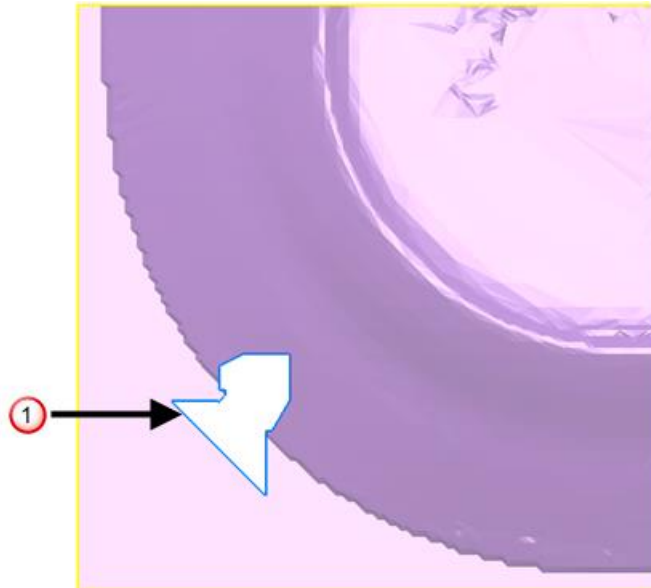

(b) Select two points to specify part of hole you want to fill first. A mark is added at the position of the first point. A line connects the first point to the second point. The area to be filled is outlined as a blue hole ②. The alternative selection is outlined by a dashed blue line ③. Swap the selection by clicking the outline of the region required.

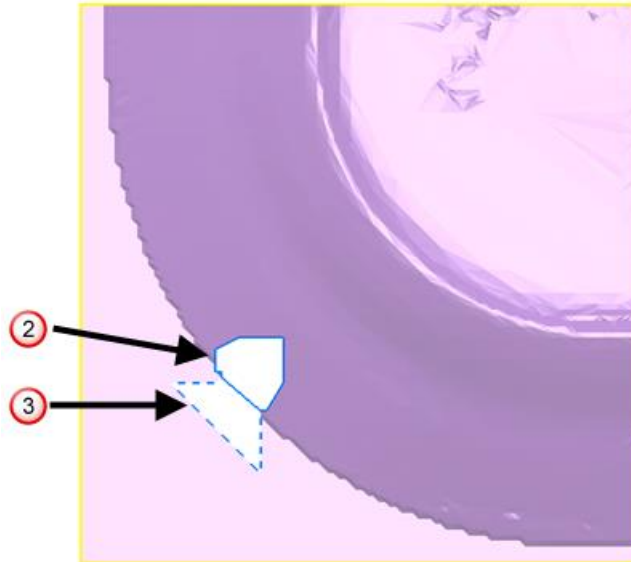

4 Select one of the following **Mode** options:

- **Curvature cap** calculates the curvature needed to fill the hole by examining the surrounding triangles. New nodes are generated on the curved area. New triangles are generated using the boundary nodes and the new nodes.
- **Planar cap** generates a nominal plane that passes through the boundary nodes (approximately if the boundary is not planar). New nodes that are within the boundary are generated on the plane. New triangles are generated using the boundary nodes and the new nodes.

The examples below show how important it is to select the correct **Mode** option. The example shows that in this case, as the hole is on a curved area, you should use the **Curvature cap** option.

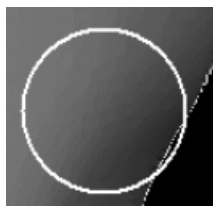

Hole filled with a **Curvature cap**



Hole filled with a **Planar cap**

The average length between nodes surrounding the hole is displayed in the **Distance between cap nodes**. This value is used to determine the density of the new nodes. Change the value as required.

- 5 Click **Apply** to apply the changes you have made and leave the dialog displayed to continue filling holes.
- 6 Click **Cancel** when you have finished filling the hole.

Stitch mesh

This option is available only when using **Delcam Designer** or **PowerSHAPE Pro**.

- 1 Select one or more meshes to display the **Mesh Edit** toolbar.
- 2 Click the **Stitch Mesh**  button on the **Mesh Edit** toolbar to open the **Stitch Mesh** dialog.

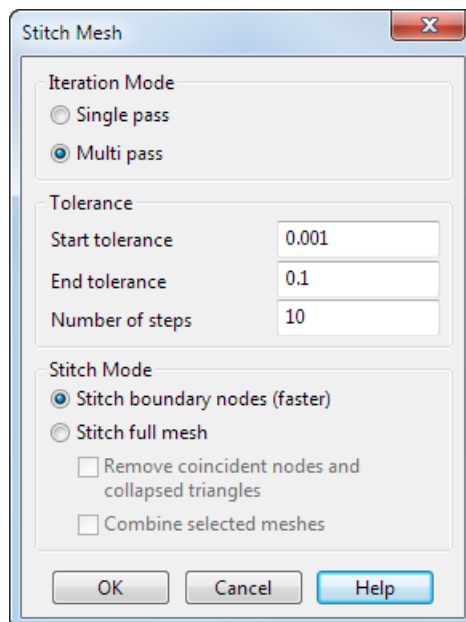

- 3 Select the **Iteration Mode**:
 - **Single pass** runs the stitch once at the given tolerance.
 - **Multiple pass** runs the stitch algorithm with the given number of steps, using logarithmic progression between the start and end tolerance. This is the default **Iteration mode**.

- 4 Set the **Start tolerance**. This is the initial tolerance you want to use for stitching.
- 5 Set the **End tolerance**. This is the final tolerance you want to use for stitching.
- 6 Set the **Number of steps** to be used when stitching.
- 7 Select the **Stitch Mode**:
 - **Stitch boundary nodes** (default option) restricts the stitch operation to the boundary nodes.
 - **Stitch full mesh** runs the stitch operation on the whole mesh. With this option selected, select one of the following to specify the stitch method:
 - Remove coincident nodes and collapsed triangles**
 - Combine selected meshes.**
- 8 Click **OK**.

Initially using the **Start tolerance**, boundaries that are close together (compared with the tolerance) are stitched by generating new triangles to join the boundaries together. The tolerance is then increased and the stitching process is repeated. This sequence continues until either the mesh is closed, or the **End Tolerance** is reached.



Stitching is applicable only where boundaries are close together. The start and end tolerance determine if it is possible to stitch the mesh. If the boundaries are too far apart, it is not possible to stitch the mesh. If there are

*sizeable holes in the mesh, use **Fill holes** (see page 73)*



Resolve overlapping triangles

This option is available only when using Delcam Designer or PowerSHAPE Pro.

Use this option to remove overlapping triangles in the selected meshes.

- 1 Select one or more meshes to display the **Mesh Edit** toolbar.



- 2 Click the **Resolve Overlaps**  button to delete overlapping triangles.



Z-compensation tool

This option is available only when using Delcam Designer or PowerSHAPE Pro.

Use the **Z-compensation** tool to cancel the overcure effect when preparing meshes for manufacture on stereolithography machines.

- 1 Create a solid sphere.
- 2 Click the **Create Meshes**  button on the **Solid Edit** toolbar to convert the solid to triangles.
- 3 Select the mesh to display the **Mesh Edit** toolbar.
- 4 Click the **Z Compensation**  button to display the **Z Compensation** dialog.

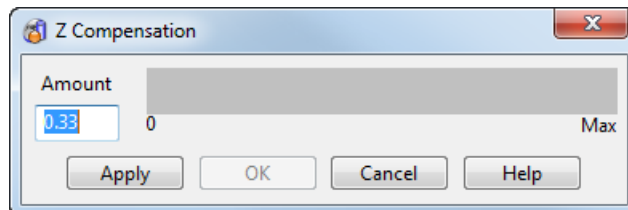

- 5 Enter an **Amount**.

- 6 Click **Apply** to display the model with the compensation applied.

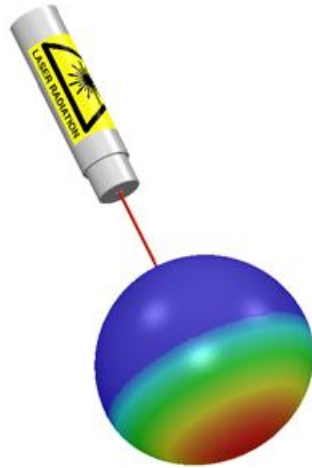
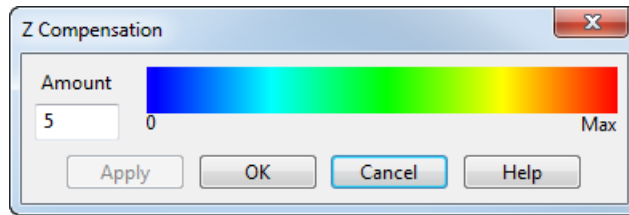

In the example a large value is used to exaggerate the effect.

Masking triangles on a mesh

Use the buttons on the **Mask** flyout to:

- **Mask selected triangles** on a mesh (see page 79).
- **Unmask selected** triangles on a mesh (see page 80).
- **Unmask all** triangles on a mesh (see page 81).

Mask selected triangles on a mesh

- 1 Select a mesh.

- 2 Hover the mouse over  to display the buttons on the **Mask** flyout.

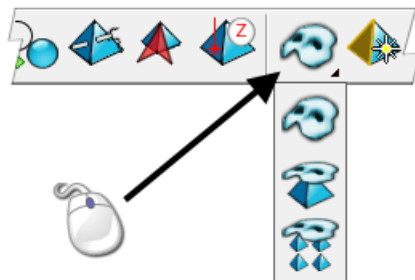

- 3 Click the **Mask**  button to mask selected triangles on a mesh. Masked triangles are hidden and drawn as transparent. They are not used in subsequent operations until they are unmasked.

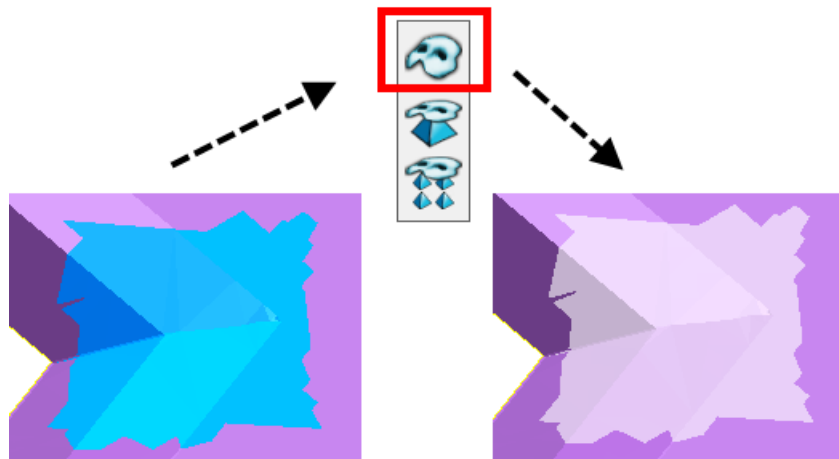

Unmask selected triangles on a mesh

- 1 Select a mesh.
- 2 Hover the mouse over  to display the buttons on the **Mask** flyout.

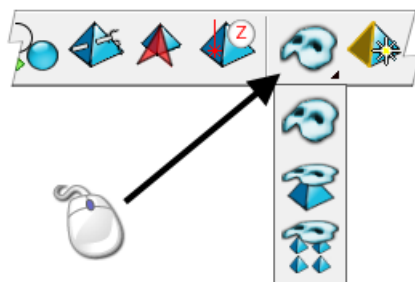

- 3 Click the **Unmask Selected**  button to unmask the selected triangles on a mesh, which enables you to use them.

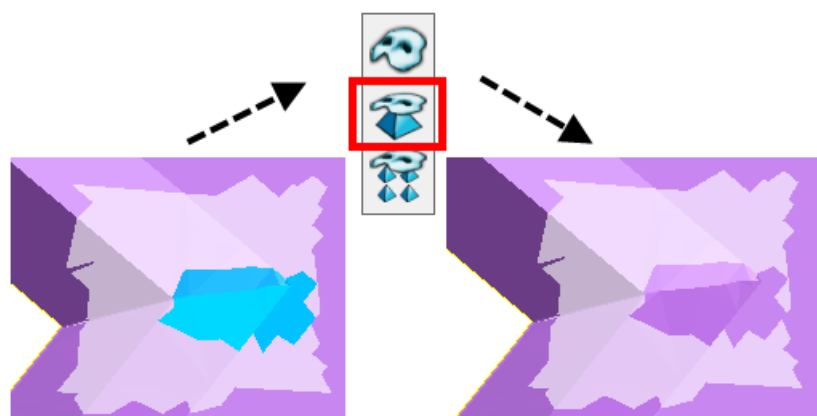

Unmasking all triangles on a mesh

1 Select a mesh.

2 Hover the mouse over  to display the buttons on the **Mask** flyout.

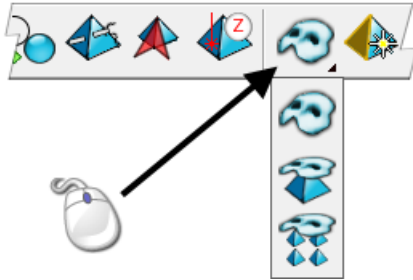

3 Click the **Unmask All**  button to unmask all triangles on a mesh, which enables you to use them.

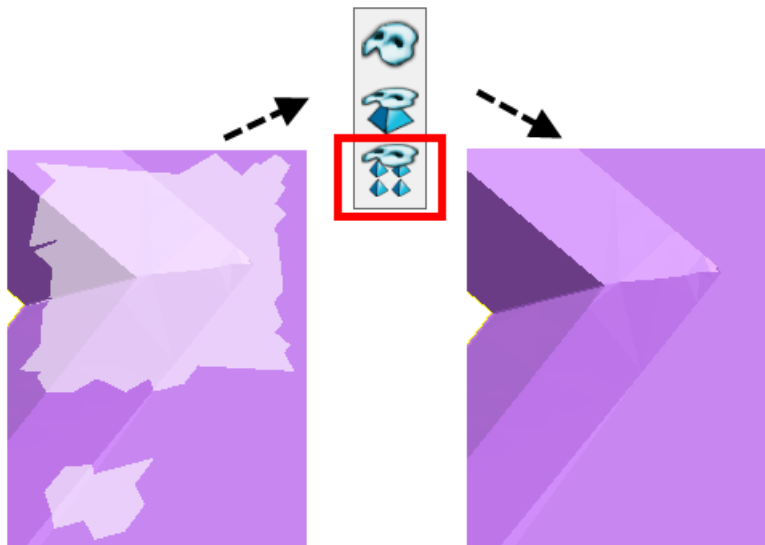

Add triangle

Select the **Add Triangle**  button to add triangles to the model by clicking on existing triangle vertices. ☆

- 1 Select a mesh.

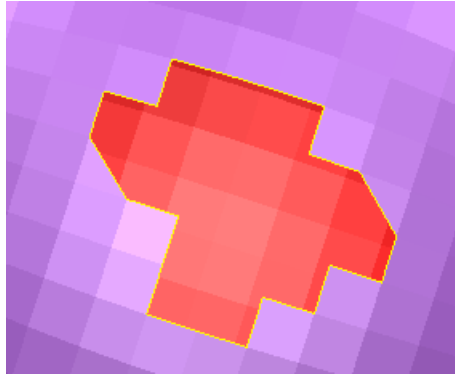

A section of the mesh shown below has some missing triangles:

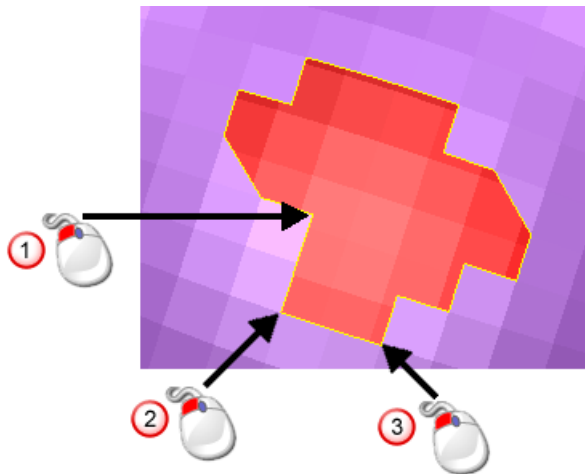

- 2 Select the **Add Triangle**  button.

- 3 Select the first point (or vertex) with the left mouse button . This point is marked in blue.



- 4 Select the second point .
- 5 Select the last point .

The new triangle is drawn. Open edges that don't match the existing triangles are drawn in yellow.

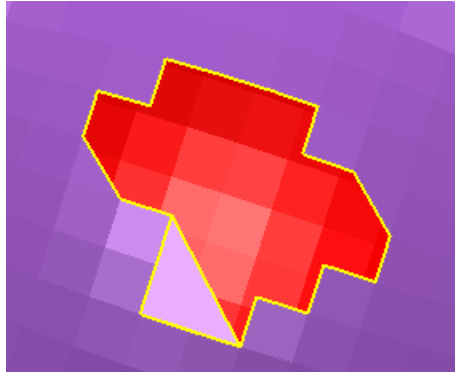



- 6 Add further triangles as required.
- 7 When you have finished adding triangles deselect the **Add Triangle**  button.

Delete triangles

Use **Delete Triangles**  to delete the selected triangles in the model.

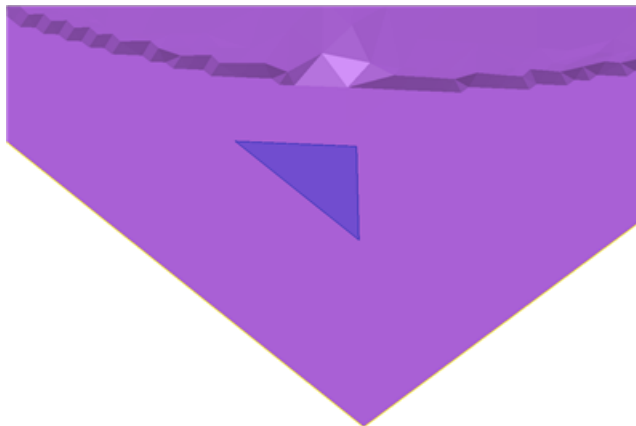
- 1 Select the triangles you want to delete. The selected triangles turn blue.



2 Click **Delete Triangles** . This removes the selected triangles

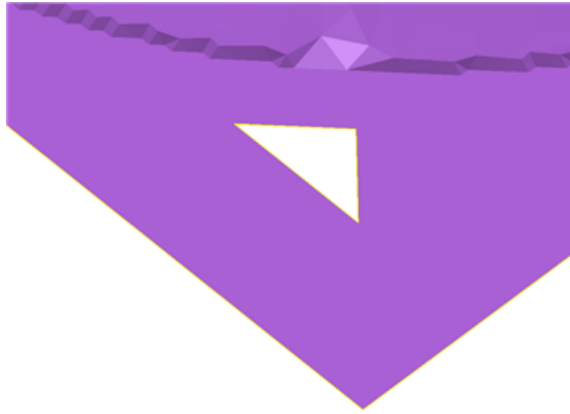

Sculpt meshes

Use **Sculpt meshes**  to change the shape of the mesh:

- 1 Click the **Sculpt meshes**  button in the **General Edits** toolbar to open the **Sculpting** toolbar. By default, the toolbar is floating, but you can dock it.

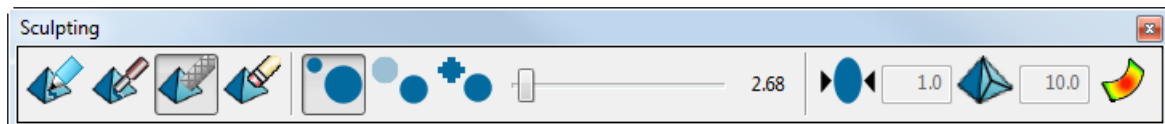

- 2 Select one of the following operations:



Add material (see page 86)



Remove material (see page 87)



Smooth (see page 88)



Erase (see page 89)

- 3 Use the following to adjust the brush:



Brush diameter — Select the button and drag the slider (or **D** + mouse scroll wheel) to increase or decrease the size of the brush.



Strength — Select the button and drag the slider (or **H** + mouse scroll wheel) to increase or decrease the amount each node is raised or lowered as a percentage of the brush radius.



Brush Smoothness — Select the button and use the slider (or **M** + mouse scroll wheel) to increase or decrease the smoothness of the area you are sculpting. The smoothness determines whether there is any reduction in the strength towards the edges of the brush.

A setting of 0% maintains full strength right to the edge of the brush.

A setting of 100% smooths the material across the diameter of the brush.

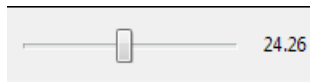

Use the slider to enter the value to be associated with the button you have selected.

- 4 Use the following to specify maximum deviation and length:



Limit deviation — Select the button and enter the maximum deviation that the nodes can move.



Refine triangles — Select the button and enter the maximum length to be used when refining triangles.



Show deviations (see page 90) — Select this button to see the difference between the original and sculpted models when using the editing tools. Deselect it to hide the differences.

Move the cursor over the model to make the required changes. When you have finished editing, click the **Exit**  button to close the toolbar.

This functionality is also available by selecting **Edit > General Edits > Sculpt Meshes**.



Use Undo and Redo (Main toolbar) to undo/redo the last action.

Sculpting triangles - Add material

Use **Add material** , in combination with the brush tools, to add material. Using **Add material** does not increase the number of triangles, but lifts the existing nodes. The orientation of the model affects the way the area is built up. To undo the add action, use the **Erase** option.

- 1 Use the following to adjust the brush:



Brush diameter — Select the button and drag the slider (or **D** + mouse scroll wheel) to increase or decrease the size of the brush.



Strength — Select the button and drag the slider (or **H** + mouse scroll wheel) to increase or decrease the amount each node is raised or lowered as a percentage of the brush radius.



Brush Smoothness — Select the button and use the slider (or **M** + mouse scroll wheel) to increase or decrease the smoothness of the area you are sculpting. The smoothness determines whether there is any reduction in the strength towards the edges of the brush.

A setting of 0% maintains full strength right to the edge of the brush.

A setting of 100% smooths the material across the diameter of the brush.

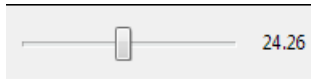

Use the slider to enter the value to be associated with the button you have selected.

- 2 Use the following to specify maximum deviation and length:



Limit deviation — Select the button and enter the maximum deviation that the nodes can move.

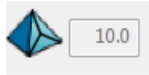

Refine triangles — Select the button and enter the maximum length to be used when refining triangles.



Show deviations (see page 90) — Select this button to see the difference between the original and sculpted models when using the editing tools. Deselect it to hide the differences.



*Move the cursor over the model to make the required changes. When you have finished editing, click the **Exit**  button to close the toolbar.*

Sculpting triangles - Remove material

Use **Remove material** , with the brush tools, to lower the triangle nodes under the brush, to make it look as though material has been carved out of the model. To undo the remove action, use the **Erase** option.

- 1 Use the following to adjust the brush:



Brush diameter — Select the button and drag the slider (or **D** + mouse scroll wheel) to increase or decrease the size of the brush.



Strength — Select the button and drag the slider (or **H** + mouse scroll wheel) to increase or decrease the amount each node is raised or lowered as a percentage of the brush radius.



Brush Smoothness — Select the button and use the slider (or **M** + mouse scroll wheel) to increase or decrease the smoothness of the area you are sculpting. The smoothness determines whether there is any reduction in the strength towards the edges of the brush.

A setting of 0% maintains full strength right to the edge of the brush.

A setting of 100% smooths the material across the diameter of the brush.

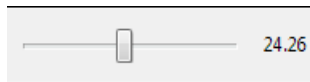

Use the slider to enter the value to be associated with the button you have selected.

- 2 Use the following to specify maximum deviation and length:



Limit deviation — Select the button and enter the maximum deviation that the nodes can move.

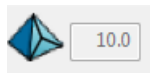

Refine triangles — Select the button and enter the maximum length to be used when refining triangles.



Show deviations (see page 90) — Select this button to see the difference between the original and sculpted models when using the editing tools. Deselect it to hide the differences.



*Move the cursor over the model to make the required changes. When you have finished editing, click the **Exit**  button to close the toolbar.*

Sculpting triangles - Smooth

Use **Smooth**  to smooth out irregularities in the triangle nodes. For each node in the smoothing area, PowerSHAPE calculates a position based on the surrounding nodes.

- 1 Use the following to adjust the brush:



Brush diameter — Select the button and drag the slider (or **D** + mouse scroll wheel) to increase or decrease the size of the brush.



Strength — Select the button and drag the slider (or **H** + mouse scroll wheel) to increase or decrease the amount each node is raised or lowered as a percentage of the brush radius.



Brush Smoothness — Select the button and use the slider (or **M** + mouse scroll wheel) to increase or decrease the smoothness of the area you are sculpting. The smoothness determines whether there is any reduction in the strength towards the edges of the brush.

A setting of 0% maintains full strength right to the edge of the brush.

A setting of 100% smooths the material across the diameter of the brush.

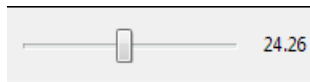

Use the slider to enter the value to be associated with the button you have selected.

- 2 Use the following to specify maximum deviation and length:



Limit deviation — Select the button and enter the maximum deviation that the nodes can move.

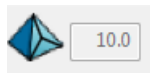

Refine triangles — Select the button and enter the maximum length to be used when refining triangles.



Show deviations (see page 90) — Select this button to see the difference between the original and sculpted models when using the editing tools. Deselect it to hide the differences.



*Move the cursor over the model to make the required changes. When you have finished editing, click the **Exit**  button to close the toolbar.*

Sculpting triangles - Erase



Use **Erase**, in combination with the **Strength**, to undo changes that you have made during the current editing session. Set **Strength** to 100% to move the node to its original position in one step. Set the option to 50% to move the node to its original position in two steps.

- 1 Use the following to adjust the brush:



Brush diameter — Select the button and drag the slider (or **D** + mouse scroll wheel) to increase or decrease the size of the brush.



Strength — Select the button and drag the slider (or **H** + mouse scroll wheel) to increase or decrease the amount each node is raised or lowered as a percentage of the brush radius.



Brush Smoothness — Select the button and use the slider (or **M** + mouse scroll wheel) to increase or decrease the smoothness of the area you are sculpting. The smoothness determines whether there is any reduction in the strength towards the edges of the brush.

A setting of 0% maintains full strength right to the edge of the brush.

A setting of 100% smooths the material across the diameter of the brush.

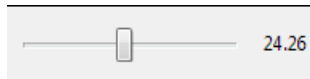

Use the slider to enter the value to be associated with the button you have selected.

- 2 Use the following to specify maximum deviation and length:



Limit deviation — Select the button and enter the maximum deviation that the nodes can move.

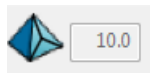

Refine triangles — Select the button and enter the maximum length to be used when refining triangles.



Show deviations (see page 90) — Select this button to see the difference between the original and sculpted models when using the editing tools. Deselect it to hide the differences.





*Move the cursor over the model to make the required changes. When you have finished editing, click the **Exit**  button to close the toolbar.*

Sculpting triangles - Show deviations

Use **Show Deviations**  to see the difference between the original and sculpted models when using the editing tools.

- 1 Select a mesh.

2 On the **General Edits** toolbar click the **Sculpt Meshes**  button to display the **Sculpting** toolbar.

3 On the **Sculpting** toolbar, select the **Add Material**  option and move the mouse to add material to the mesh.



4 Select the **Show Deviations**  option to see the difference between the original and the sculpted model. The analysis scale enables you to see the percentage of material that you have added to the model.

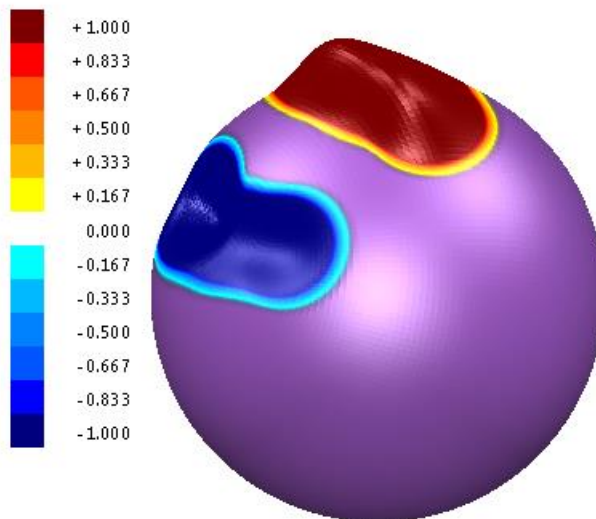

Alternatively, select **Show Deviations**  before adding the material to see the dynamic changes.

Combining selected meshes

Use this option to combine selected meshes.

- 1 Select one or more meshes to display the **Mesh Edit** toolbar.



- 2 Select **Object > Mesh > Combine**.

The meshes are joined to create a single mesh.

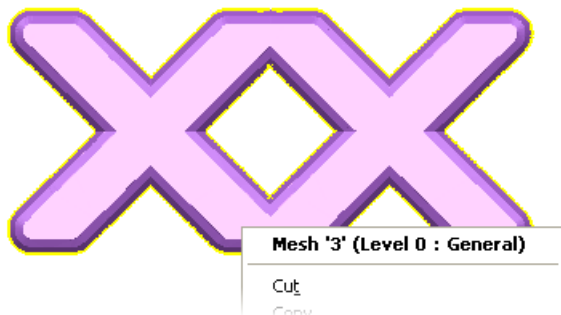



Shading meshes

On the **Views** toolbar, use the options on the **Mesh representation** flyout to shade meshes:

- 1 Select a mesh.

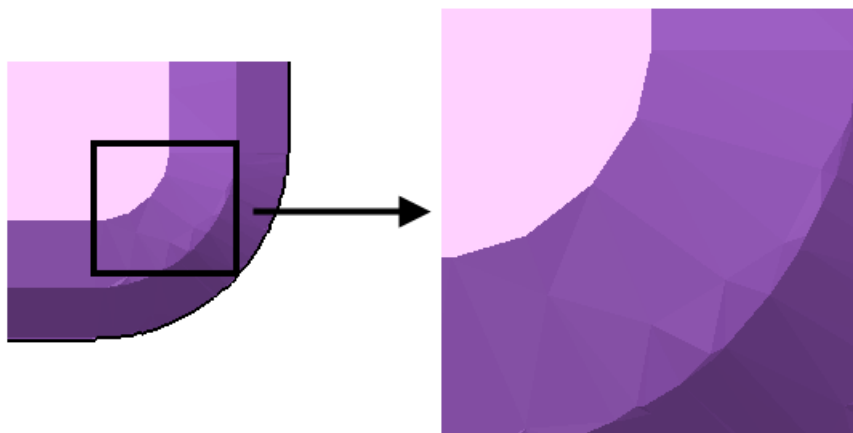
The following section is used to show the effect of the different buttons:



- 2 Right-click  on the **Views** toolbar to display the **Mesh representation** flyout.

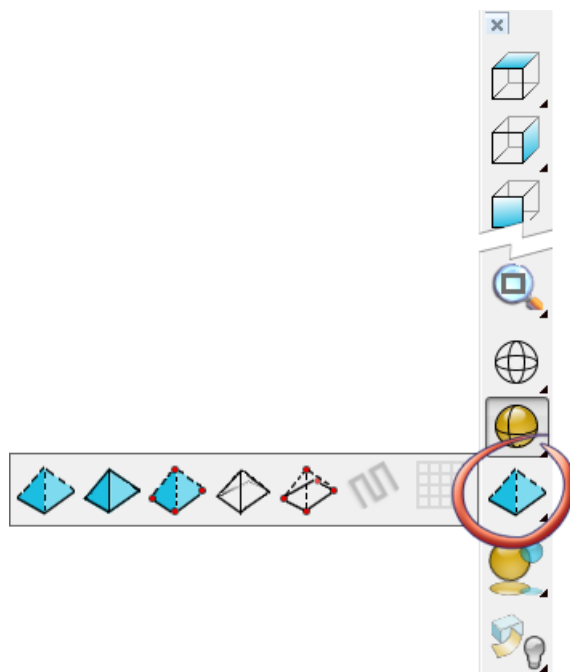

- 3 Select each button in turn to see the effect on the model.



Nodes and open edges, hollow — Select this option to display nodes and open edges over hollow triangles.

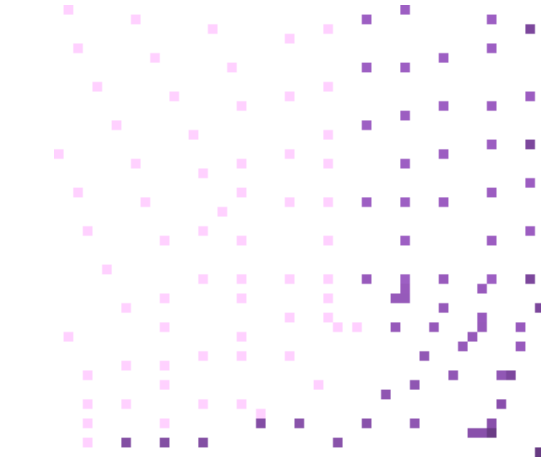

The graphic above has been magnified so that the nodes are visible.



Open and interior edges, hollow — Select this option to display open and interior edges over hollow triangles.

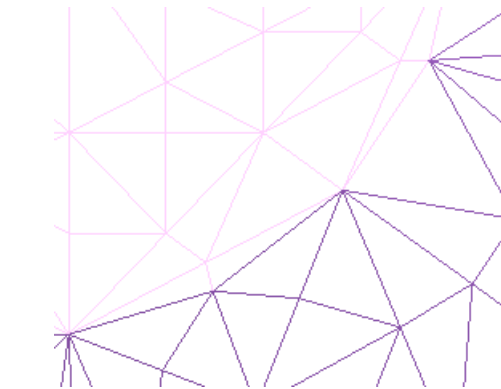

Nodes and open edges, shaded — Select this option to display nodes and open edges over shaded triangles.

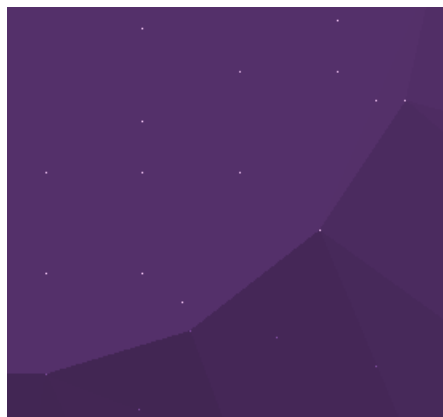



Open and interior edges, shaded — Select this option to display open and interior edges over shaded triangles.

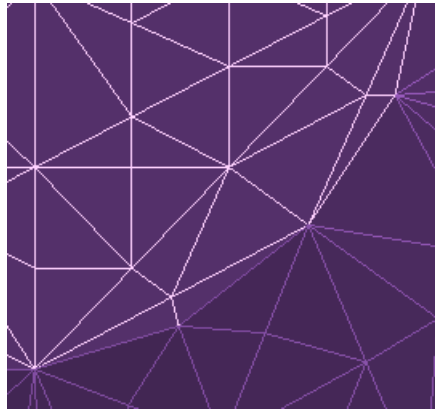

Open edges only — Select this option to show meshes as open edges only.



Renaming a mesh

To rename a mesh:

- 1 Select one of the following:
 - Select **Object > Mesh > Rename**.
 - Select **Rename mesh** from the **Mesh** context menu.

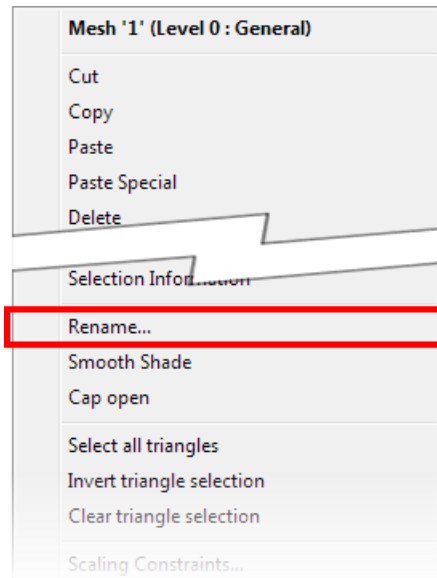

The **Rename Mesh** dialog is displayed:

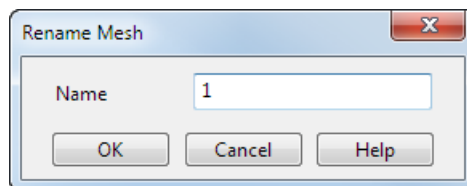

- 2 Enter a name into the **Name** field.
- 3 Click **OK** to rename the mesh.

Smooth shading of meshes

You can smooth a mesh to improve the appearance of the faceted triangle mesh. You can use this option on imported files that contain triangles but do not contain normals, such as `.stl`, `.dmt` or `.obj` files.

To use Smoothing

- 1 Import a triangle file that does not contain normals. The example shown below is a `.dmt` file of part of a shoe sole.

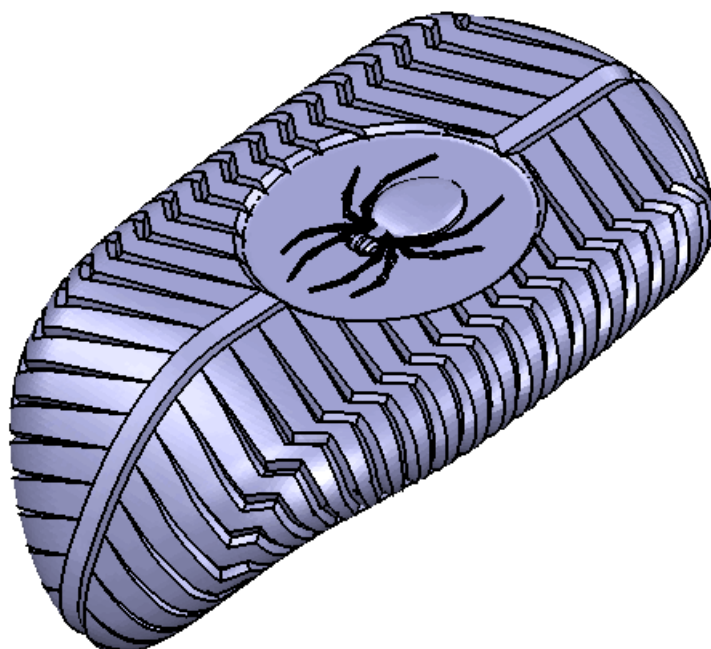

The appearance is faceted.

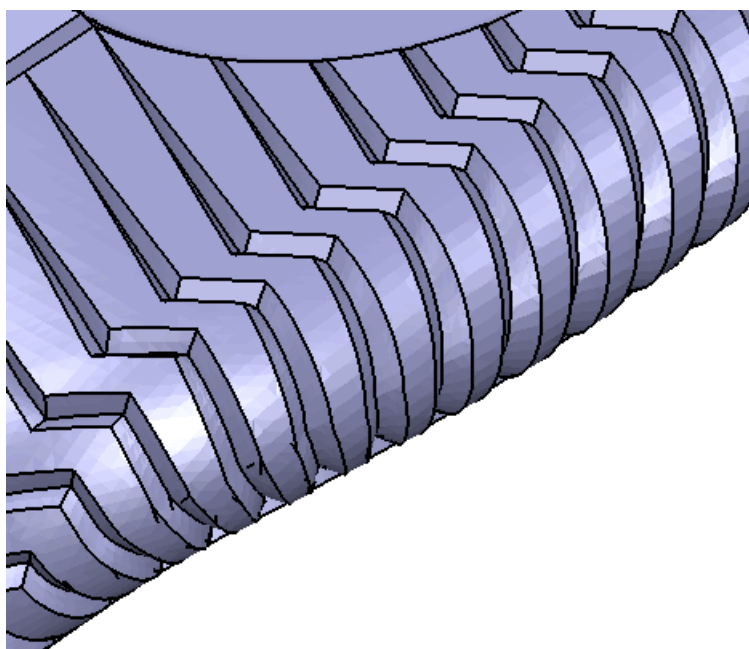

- 2 Click the **Smooth Normals**  button on the **Mesh Edit** toolbar. The **Smooth Normals** dialog (see page 98) is displayed where you specify the degree of smoothing required.

Smooth Normals dialog

Use this dialog to specify the degree of smoothing to improve the appearance of the triangle mesh on imported triangle files.

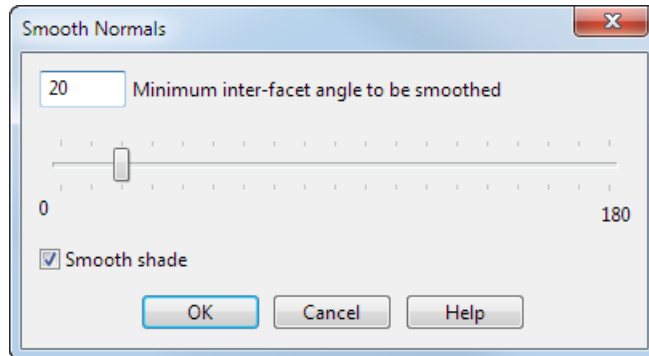

Minimum inter-facet angle to be smoothed — When you first open the **Smooth Normals** dialog, the default smoothing setting is automatically selected. You can enter a new value or use the slider to reduce and increase the smoothness of the facets to control the appearance of the triangle mesh.

The two examples below show the difference in the appearance of the facets.

Imported .dmt file with no smoothing

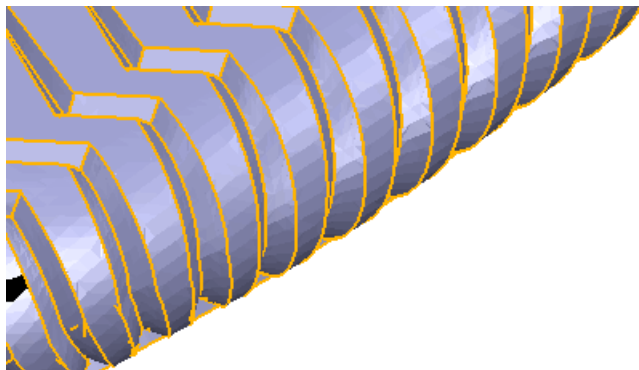

Imported .dmt file with smoothing applied

The appearance of the model is improved by reducing faceting whilst preserving the intentional sharp edges.

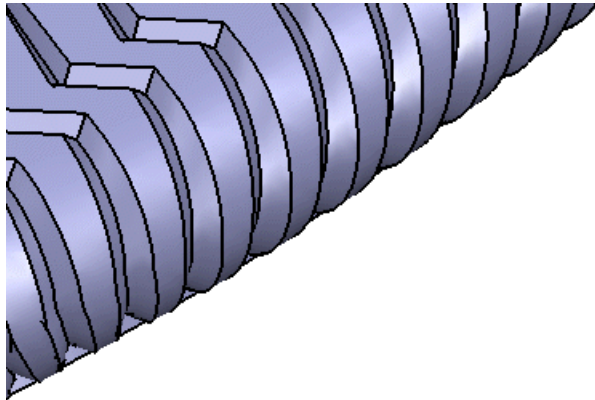

The two examples below show the results of using extreme values.

Small amount of smoothing

In the example below, the angle value used is too small and many facets have not been smoothed, reducing the quality of the appearance.

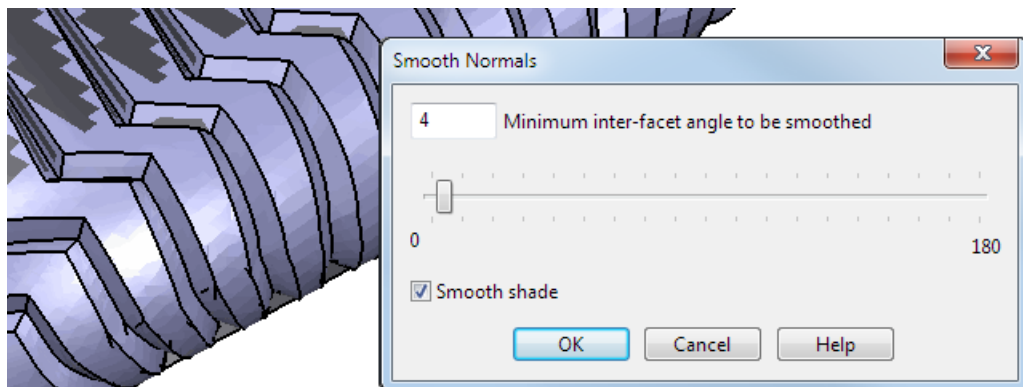

High amount of smoothing

In the example below, the angle value used is too high and many intentional sharp edges have been smoothed, spoiling the appearance.

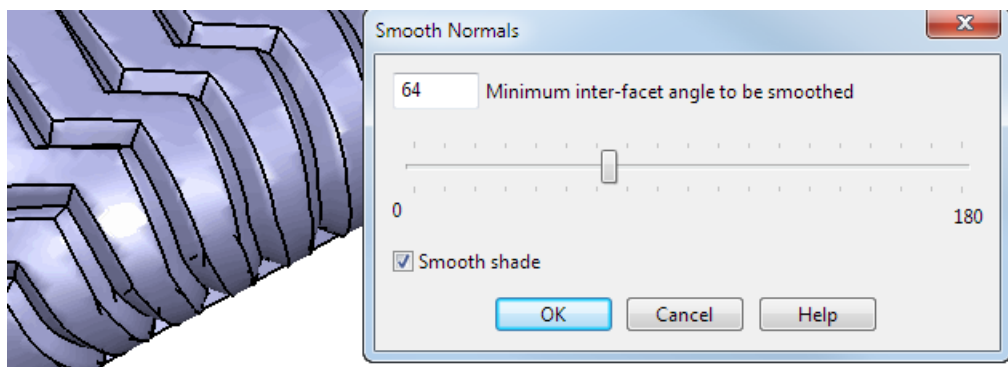



Smooth shade — Select this option to toggle Smooth Shading on or off. You can also toggle this option by right-clicking the model and selecting **Smooth Shade** from the **Mesh** context menu.

OK — Applies the specified smoothing.

Offsetting a mesh

To offset a mesh:

- 1 Select the mesh to offset.
- 2 On the **General Edits** toolbar click the **Offset object**  button.
- 3 On the **Offset** toolbar, select **Round Discontinuities**  and enter a **Distance**.

The mesh is offset.

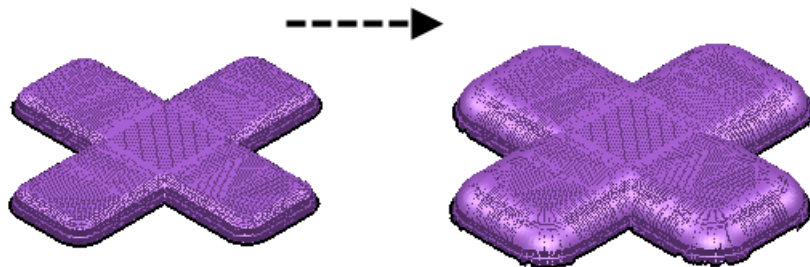

Converting meshes

Use the **Mesh** context menu to complete the following conversion:

Convert to mesh (see page 100)

Convert a mesh to a solid (see page 102)

Converting to meshes

Convert a single solid to a mesh

- 1 Select a solid.
- 2 On the **Solid Edit** toolbar, click the **Create Meshes**  button.

Convert a single or multiple solids

- 1 Select one or more solids.
- 2 Select **Edit > Convert > Selection to Meshes**.

Convert a surface to a mesh

- 1 Select one or more surfaces.

- 2 Right-click on the selection.
- 3 Select **Convert to Mesh** from the menu.

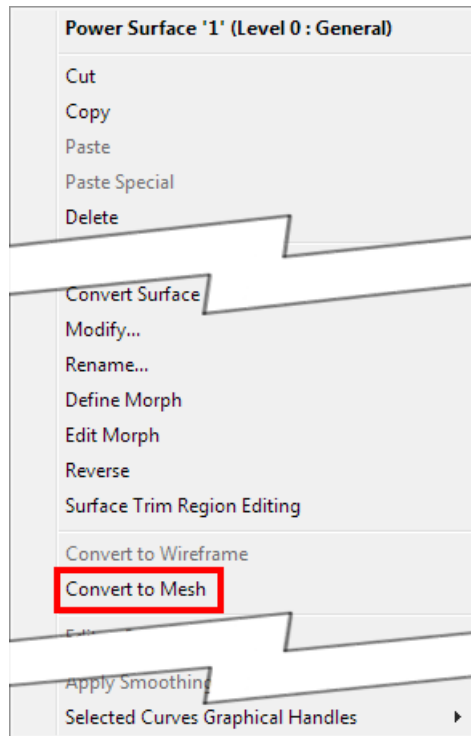

Alternatively, select **Edit > Convert > Selection to Meshes**.

Convert a mixture of solids and surfaces to meshes

- 1 Select the solids and surfaces.
- 2 Select **Edit > Convert > Selection to Meshes**.

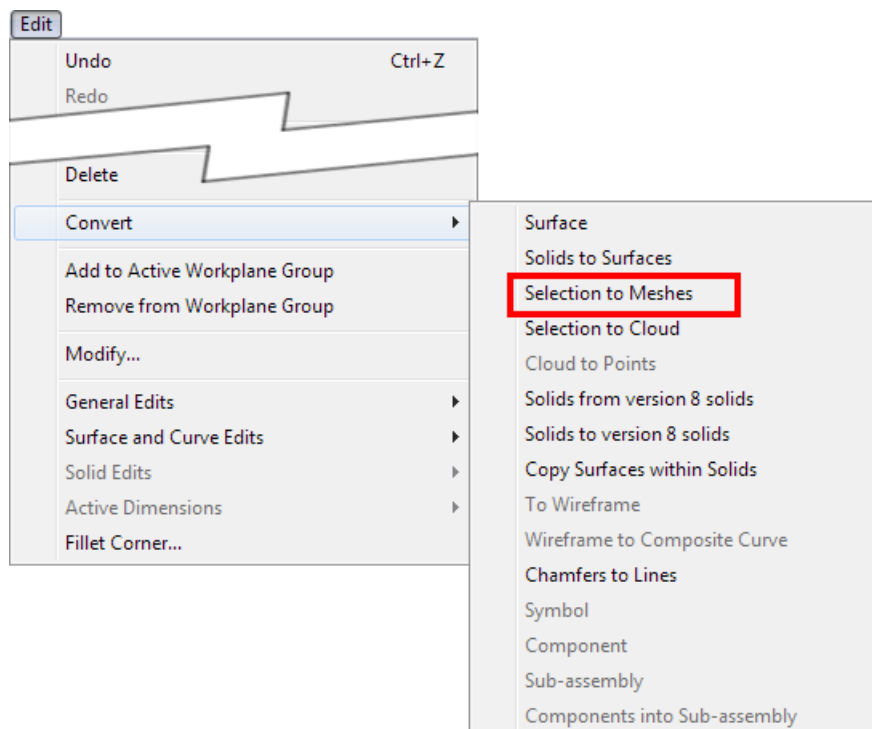

Converting a mesh to a solid

Convert a mesh and a surface to a solid

- 1 Select a mesh and a surface.
- 2 Click **Create solid from selection of surfaces or meshes**  (Solid toolbar).

A solid is created from the selected surface and mesh.

Convert a mesh to a closed solid

- 1 Select a mesh.
- 2 Click the selection with the right mouse button to display the **Mesh** context menu.
- 3 Select **Cap open**.

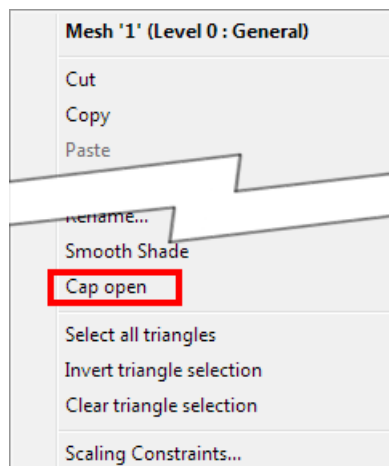

A capped solid is created from the mesh.

Creating curves

Use the Mesh options on the **Curve** toolbar to create curves from meshes:

Curve snapped to mesh (see page 103).

Curve at discontinuities in a mesh (see page 105).

Curve from mesh boundary (see page 106).

Create curve snapped to mesh

Use this option to create a curve snapped to a mesh.

1 Select a mesh.

2 Click the **Create Curve Snapped to Mesh**  button on the Curve toolbar.

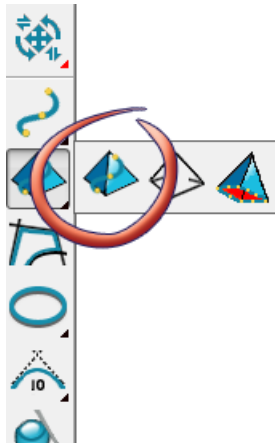

The **Create Curve Snapped to Triangles** toolbar is displayed.

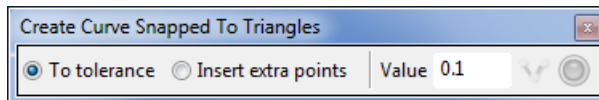

3 Select one of the following options to specify the way the curve is created:

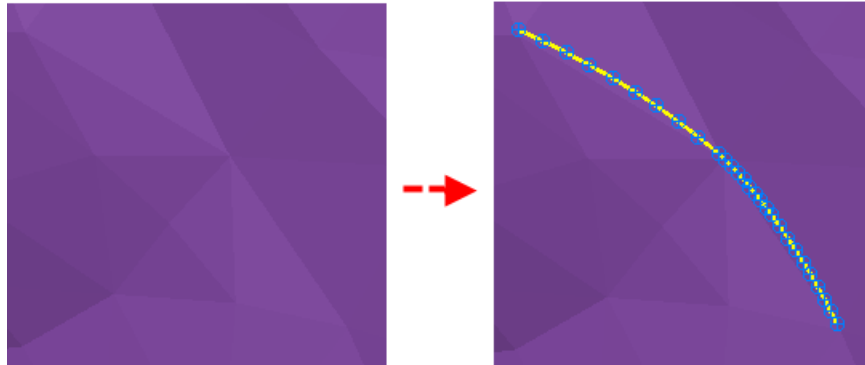

- Select **To tolerance** to automatically insert additional points so that the curve lies on the triangles to tolerance. The example below is to tolerance **0.01**.

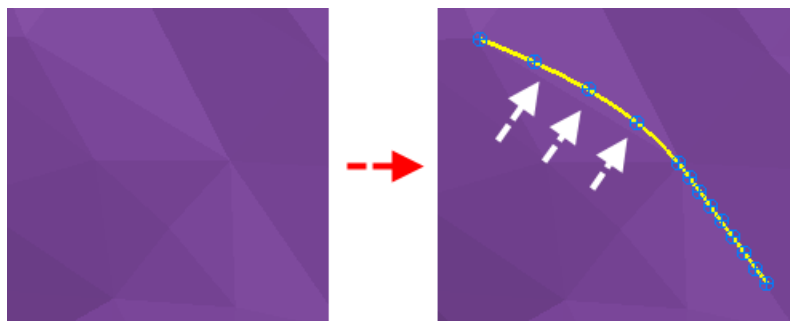

- Select **Insert extra points** to create a fixed number of points per span. Enter the number of points in **Value**. If you enter a **Value** of zero to create a curve with zero breakpoints. The points will lie on the triangles. Spans may not be within tolerance.

The example below has 3 points per span. In this case, the highlighted area shows that the curve does not follow the triangles as accurately as using **To Tolerance**.



- 4 Click the **Insert Discontinuity**  button to end the current curve at the previous point and start a new curve from the same point. The new curve is non-tangential to the first curve.
- 5 Click the **Save**  button to finish the curve.
- 6 Close the toolbar to view the curve and the points.

This functionality is also available by selecting **Object > Curve > Curve Snapped to Mesh**.

Creating a curve at discontinuities in a mesh

To create a curve on a mesh where discontinuities are greater than a certain angle:

- 1 Select a mesh.

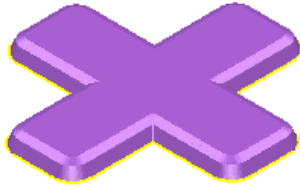

- 2 Click the **Create curve at discontinuities in mesh**  button (*Curve toolbar*).

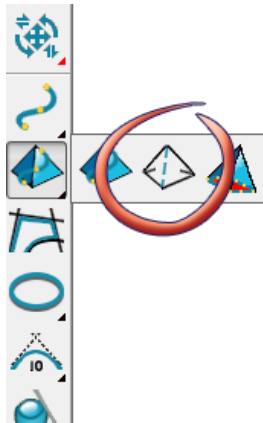

The **Mesh Discontinuities** dialog is displayed.

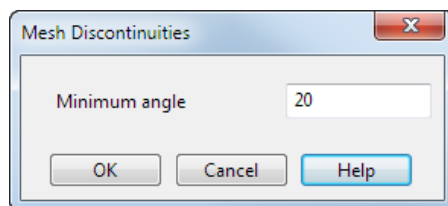

- 3 Enter the minimum discontinuity angle or click the right mouse button to open the **Calculator**.
- 4 Click **OK** to create composite curves where the discontinuities are greater than the angle that you entered.

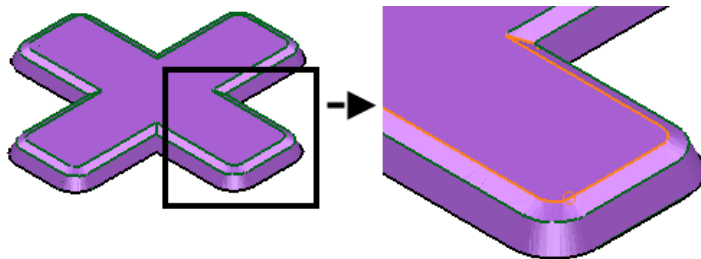

This functionality is also available by selecting **Object > Curve > Discontinuities from Mesh**.

Create curves from mesh boundary

To create a curve from a mesh boundary:

1 Select a mesh or some triangles in a mesh.

2 Click the **Curve From Mesh Boundary**  button on the **Curve** toolbar to display the curve and the **Curve options** dialog.

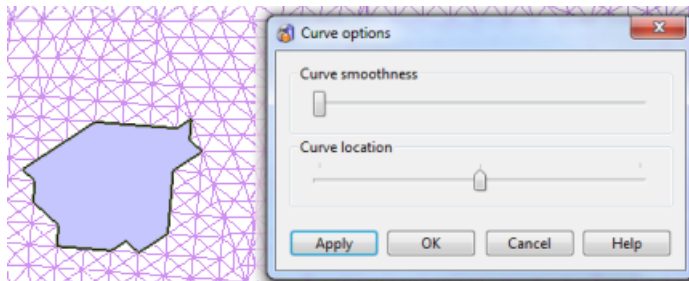

3 Using the sliders on the dialog:

- Adjust the **Curve smoothness** of the curve. If you wish to define the curve location, move the **Curve Smoothness** slider from the original position.
- Define the **Curve location**. If the **Curve smoothness** slider is in the original position, moving this slider has no effect on the curve that is created.

There are three positions for the curve:

Outside — The curve is positioned so that it is enclosing all the selected triangles.

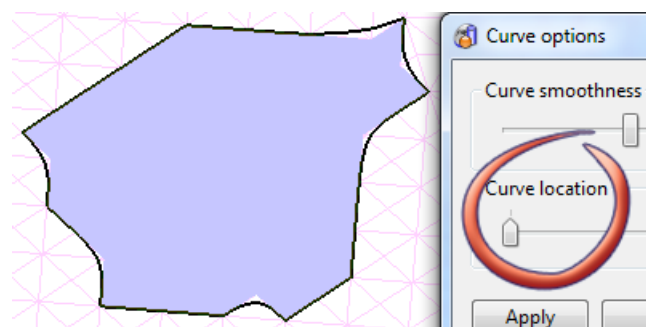

Average — The curve is positioned so that some triangles are within the curve and some are outside the curve.

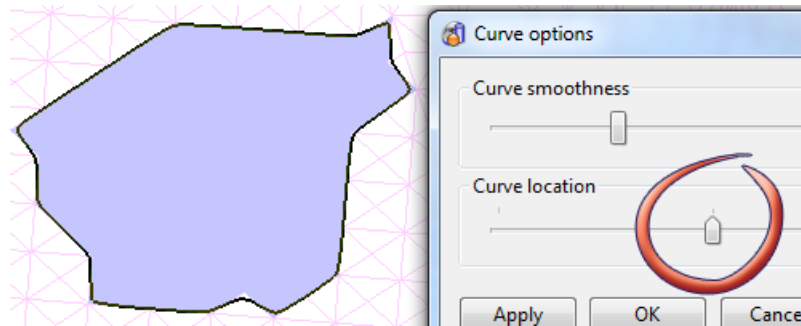

Inside — The curve is entirely inside the selected triangles.

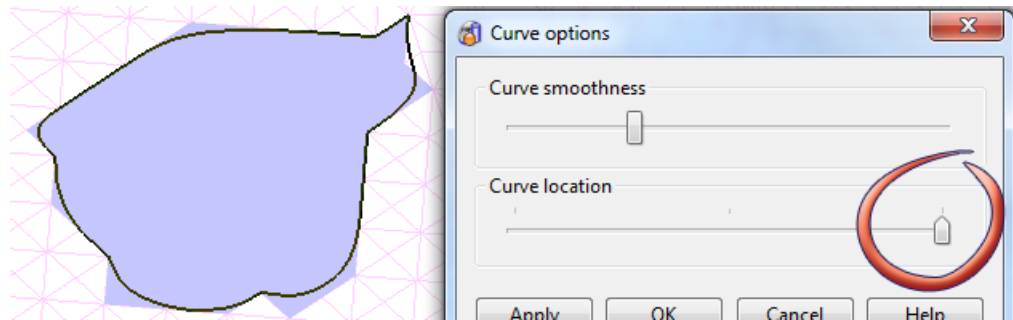

- 4 Complete the creation of the composite curve by:
 - Clicking **Apply** to create the composite curve, leaving the dialog displayed. Adjust the sliders as required.
 - Clicking **OK** to accept the changes and close the dialog. A composite curve is created from the mesh boundary.

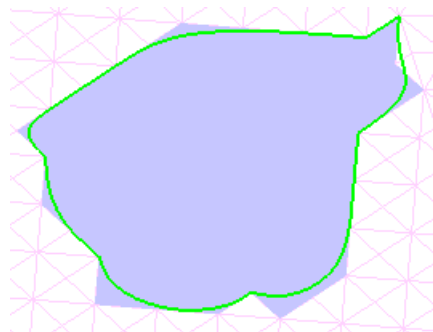

- 5 To view the composite curve:
 - a Right-click the mesh.

- b Select **Blank** from the context menu to blank the mesh. The composite curve remains.

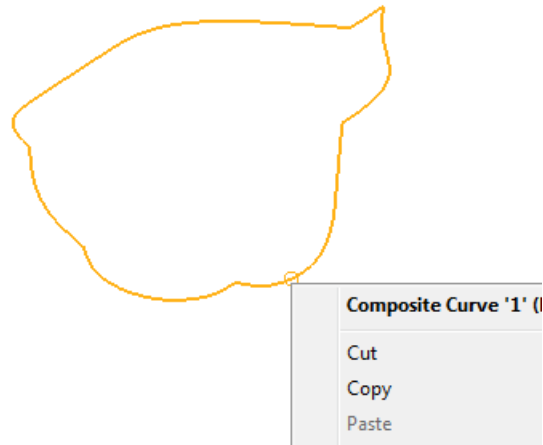

- 6 Edit the composite curve as required using graphical editing techniques.



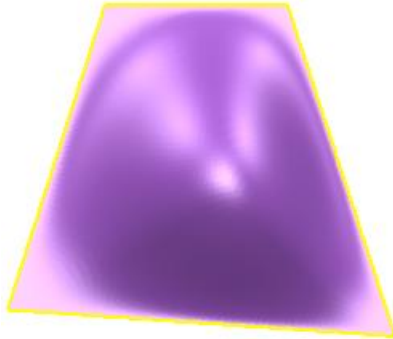

Surface from triangles

When creating a surface from the triangles in a mesh, the triangles used to create the surface will become masked.

- 1 Select a mesh.



- 2 Select the **Surface From Mesh**  button on the **Surface** toolbar.
- 3 Create a surface from a mesh:

- Pick points on the mesh to create a closed curve. When completing the curve,  is displayed when you move the cursor near the start point
- Click  to define a corner at the last click point.
- Use  to define a corner at the click point.
- Use  to add a straight section to the curve.

The model below shows two surfaces created from the mesh.

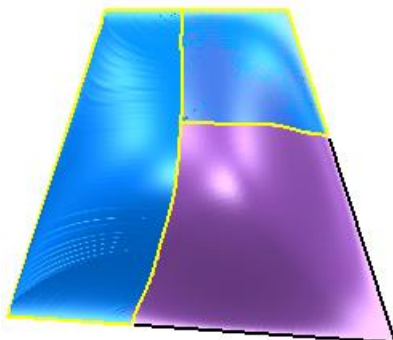

Boolean operations

Use Boolean operations to create a mesh from

- two meshes
- a solid and a mesh

Two meshes

Use the Boolean operations (Feature toolbar) to intersect, subtract, or combine two meshes.

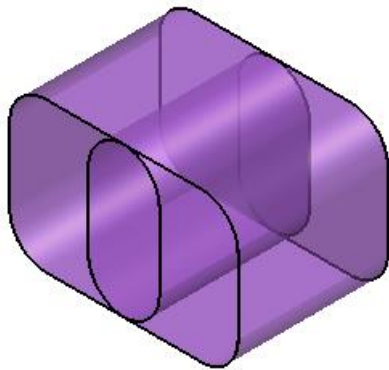

Create a mesh from the intersection of two meshes as follows:

- 1 On the **Feature** toolbar, click the **Intersect**  button to display the **Boolean Intersection** dialog.
- 2 Select **①** as the **Primary selection** and **②** as the **Secondary selection**.
- 3 Click **OK** to create the new mesh.

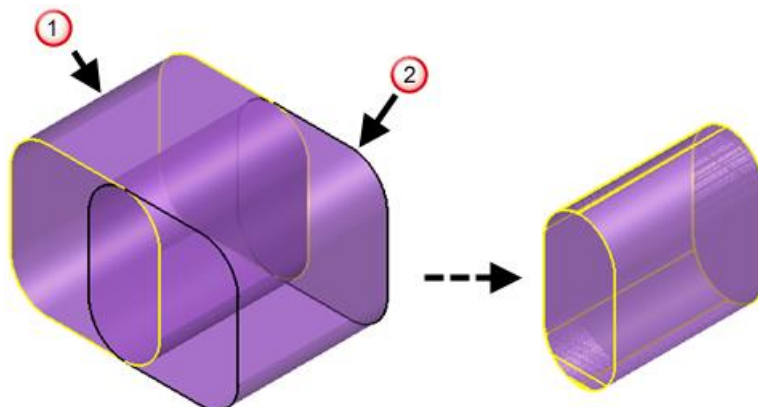

Solid and mesh

Use the Boolean operations on the **Feature** toolbar to intersect, subtract, or combine a solid and a mesh.

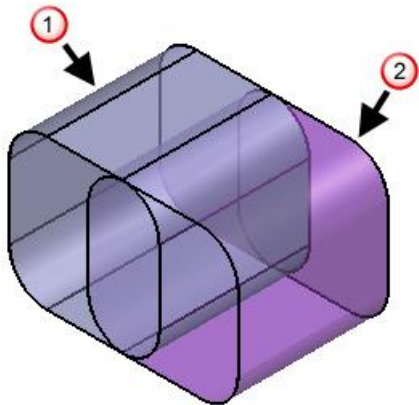

Create a mesh by subtracting a mesh from a solid as follows:

- 1 Click  **Subtraction** (Feature toolbar) to display the **Boolean Subtraction** dialog.
- 2 Select **1** as the **Primary selection** and **2** as the **Secondary selection**.
- 3 Deselect **Keep original solids**.
- 4 Click **OK** to create the new mesh.
- 5 Click **Yes** to delete the Feature tree, if it already exists.

