



# Getting Started in | FeatureCAM 2011

---

FeatureCAM 2011

# Getting Started



Copyright © 1995-2010 Delcam plc. All rights reserved.

Delcam plc has no control over the use made of the software described in this manual and cannot accept responsibility for any loss or damage howsoever caused as a result of using the software. Users are advised that all the results from the software should be checked by a competent person, in accordance with good quality control procedures.

The functionality and user interface in this manual is subject to change without notice in future revisions of software.

The software described in this manual is furnished under licence agreement and may be used or copied solely in accordance with the terms of such licence.

Delcam plc grants permission for licensed users to print copies of this manual or portions of this manual for personal use only. Schools, colleges and universities that are licensed to use the software may make copies of this manual or portions of this manual for students currently registered for classes where the software is used.

### **Acknowledgements**

This documentation references a number of registered trademarks and these are the property of their respective owners. For example, Microsoft and Windows are either registered trademarks or trademarks of Microsoft Corporation in the United States.

FeatureCAM Version: 2011 Date: 15 September 2010 10:02

# Contents

<b>Introduction</b>	<b>1</b>
Special features in this guide .....	2
Tell us what you think .....	2
<b>FeatureCAM overview</b>	<b>3</b>
Why creating toolpaths is so fast .....	4
What's new in this release .....	5
Website.....	5
<b>Using FeatureCAM</b>	<b>6</b>
Starting FeatureCAM for the first time .....	6
Opening a part.....	9
Closing the Stock wizard .....	11
Creating a simple part .....	12
Saving your work .....	14
Interface tour .....	15
Title bar .....	16
Menu bar .....	16
Toolbars .....	17
Graphics window .....	26
Steps panel .....	31
Part View panel.....	45
Browser .....	47
Results window .....	49
Assistance bar .....	50
Feature/Geometry Edit bar .....	50
Status bar.....	50
Printing.....	51
Keyboard shortcuts .....	52
Getting help.....	54
<b>Introduction to 2.5D milling</b>	<b>56</b>
Creating a part file .....	56

Viewing.....	60
Toolpaths.....	61
Order of manufacturing operations.....	62
Part documentation .....	65
Controlling the automation .....	67
NC code.....	68
Tool mapping.....	68
Changing post processors .....	69
Saving NC code .....	70

## **Features from curves 71**

Getting started.....	72
Setting the snaps .....	73
Building circles.....	73
Drawing lines.....	74
Chaining a curve .....	76
Creating a feature from a curve .....	77
Simulating the part.....	78
Modifying the boss feature to contour around the part .....	78
Changing the plunge point.....	79

## **Introduction to turning 82**

Getting started.....	82
Create a part file.....	82
Making features .....	86
Viewing.....	90
Toolpaths.....	91
Ordering of operations .....	92
Part documentation .....	94
NC code.....	94
Changing post processors .....	95
Saving NC code .....	95

## **Introduction to turn/mill 97**

Getting started.....	97
Creating a turn feature .....	98
Viewing.....	101
Creating a radial hole pattern on the face .....	102
Engraving on the face .....	104
Creating a pattern of wrapped slots .....	106
Simulating a turn/mill part.....	106

## **Creating features from 3D CAD models 108**

Getting started.....	108
Importing the CAD model .....	109
Aligning the model .....	111
Shading the part .....	113
Automatic feature recognition .....	114
Recognizing holes.....	115
Recognizing pockets .....	117
Creating a slot feature .....	119
Creating a side feature .....	120
Simulating the entire part.....	122

## **Introduction to 3D milling 124**

Getting started.....	124
Creating the bottle surface .....	127
Viewing.....	128
Creating a surface milling feature.....	130
Simulating the entire part.....	131

## **Introduction to 5-axis simultaneous 133**

Getting started.....	133
Creating a surface milling feature.....	134
Importing geometry .....	137
Adding flowline operation .....	138
Recognizing holes.....	142
Recognizing side features .....	143

## **Solid modeling basics 146**

Getting started.....	147
Creating the initial solid.....	147
Hidden line graphics .....	151
Creating the curved lower surface .....	153
Creating constant and variable radius fillets.....	158
Adding thickness.....	160
Creating a mold cavity .....	162

## **Introduction to WIRE 164**

Getting started.....	164
Creating the profile .....	165
Creating a wire EDM feature.....	167

Simulating a wire EDM toolpath.....	168
Generating NC code.....	170
Adding a taper angle .....	170
Creating the second profile .....	173
Creating a 4-axis wire EDM feature .....	175
Modifying the start point .....	177
Matching the curves .....	178
Simulating the part.....	180

## Index

**183**

# Introduction

This guide is designed to quickly get you up to speed with FeatureCAM. By the time you finish this guide, you'll know enough about FeatureCAM to use it straight away. You may also find this guide useful, if you have upgraded FeatureCAM, and want to learn the new modules.

FeatureCAM is very easy to use, and does not require any specialist computing knowledge. However, you need to know how to use the mouse, the keyboard, and the Windows environment.

## **If you want to know more**

You can find details on using specific features in the online help system included with FeatureCAM.



---

## Special features in this guide

Names of dialogs, menus, toolbars, and menu options appear in **boldface**.

The menu names are separated from the specific command on that menu with a '>'. For example, a phrase 'select **View > Simulation**' instructs you to open the **View** menu and select the **Simulation** option.

Any text that you have to type in a dialog or a text box appears in **blue boldface** type.

### Icons



A note icon draws your attention to something that may not work the way you think it should, and helps you to avoid common errors or hidden pitfalls.



A tip icon is here to save you time, and shows you a more efficient way of doing things in FeatureCAM.



A warning icon tells you how to avoid serious problems.

---

## Tell us what you think

Tell us what you think of this guide. We need your opinion. We want to know what we are doing right, and what we could do better.

Email your thoughts to *documentation@featurecam.com*.

Thank you for choosing FeatureCAM!

# FeatureCAM overview

FeatureCAM is a CAD/CAM software suite that automates machining and minimizes programming times for parts on mills, lathes, and wire EDM. Unlike operations-based CAM systems, FeatureCAM generates toolpaths based on the features of the part, and automatically selects appropriate tools, determines roughing and finishing passes, and calculates feeds and speeds. The selections made can be based on the built-in machining knowledge that Delcam supplies 'out-of-the-box' with FeatureCAM, or from experience captured from your company, project or individual users' preferences.

FeatureCAM includes five stand-alone modules:

- **MILL** - 2.5D design and toolpath generation for 2- and 3-axis mills.
- **MILL3D** - 3D surface modeling and 3-axis toolpath generation.
- **TURN** - 2-axis design and toolpath generation for 2-axis lathes.
- **TURN/MILL** - Supports lathes with C and Y-axis milling capabilities.
- **WIRE** - 2- and 4-axis wire EDM toolpath creation.

The following add-on modules are also available:

- **RECOGNITION** - 3D surface and solid import and the recognition of 2.5D features from solid models. Accelerates making 2.5D and turned parts from solid models.
- **Solid Modeling** - Solid modeling and tools for creating molds from solid models.
- **5-Axis Positioning** - Manufacture 2.5D features from 5-axis orientations.

- **5-Axis Simultaneous** - Manufacture 3D features while changing the tool axis.
- **Tombstone** - Multiple part manufacturing for horizontal or vertical milling machines with indexers.
- **Native Import Modules** - Native data can be read directly from SolidWorks, SolidWorks Assemblies, Autodesk Inventor, SolidEdge, CATIA, Unigraphics, Pro-Engineer, and STEP files.
- **Machine Simulation** - Modeling and simulation of a CNC machine.
- **Advanced Turn/Mill** - Includes support for TURN/MILL in addition to support for B-axis (5-axis positioning) and turret synchronization.
- **Network Database and Licensing** - Flexible product licensing allows sharing FeatureCAM licenses across a network.

---

## Why creating toolpaths is so fast

FeatureCAM has the unique ability to generate toolpaths and create NC code to run the machines with a minimum amount of user input.

Traditional CAM systems are *operations-based* and require you to program every operation, one at a time, to create your part. FeatureCAM is *feature-based*; this means the part is created using features that describe that part, from simple holes, to complex pockets, to turned grooves. Machinable features contain information and rules describing how and where material removal should occur, cutting depths, whether to use climb cutting, whether to spot drill or center drill, and preferred machining strategies for roughing and finishing. This means that after you import or draw the part and identify its features, FeatureCAM automatically:

- Selects the most appropriate tools and operations;
- Recommends machining strategies;
- Calculates speeds and feeds;
- Generates toolpaths and creates the NC code.



*You can customize this built-in 'intelligence' to your own style of cutting.*

---

## What's new in this release

If you are an existing FeatureCAM user and want to find out about new functionality and other changes to FeatureCAM, see the **What's New** section of the FeatureCAM help file.

---

## Website

The website *www.featurecam.com* contains useful information for FeatureCAM users including:

- New product announcements
- Comprehensive database of technical tips
- Maintenance releases
- User forum
- Evaluation copies of new software
- Local dealer information
- Trade shows where FeatureCAM is being exhibited
- Software updates

# Using FeatureCAM

As with any software program, the key to efficiency is being able to control the program effectively using its interface. This chapter covers FeatureCAM basics, such as starting FeatureCAM for the first time, getting help as you work, mastering different components of the FeatureCAM interface, and following the basic steps to create a part.

---

## Starting FeatureCAM for the first time

1. From the **Start** menu, select **All Programs > FeatureCAM > FeatureCAM**.



*You can also start the program by double-clicking the FeatureCAM  icon on the desktop.*

The first time you start FeatureCAM, it runs the INITDB Initialization program to create the tools and materials database.

2. Click **OK** to begin the configuration.

The **Tool and Material Setup** dialog opens.

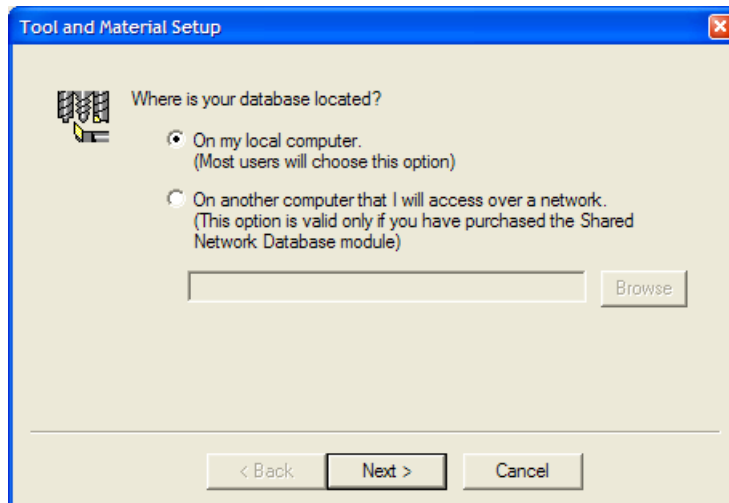

3. If you want to create a local database, select **On my local computer**.

If you want multiple computers to have the ability to use the same tool and material information:

- a. Select **On another computer that I will access over a network**.
- b. Click the **Browse** button, and use the **Database Location** dialog to select the folder where the database is located.



*You need to create a database folder on your network first, and then copy an empty MDB database from the FeatureCAM CD-ROM to this location.*

*The default database is created by MS Access, and should be accessed using the MS Jet database driver. You may use a different database type, such as MS SQL Server. For more information, refer to the online help.*



*You need to have the **Shared Network Database** module to use this option.*

4. Click the **Next** button to continue.

5. Choose the tools to load:

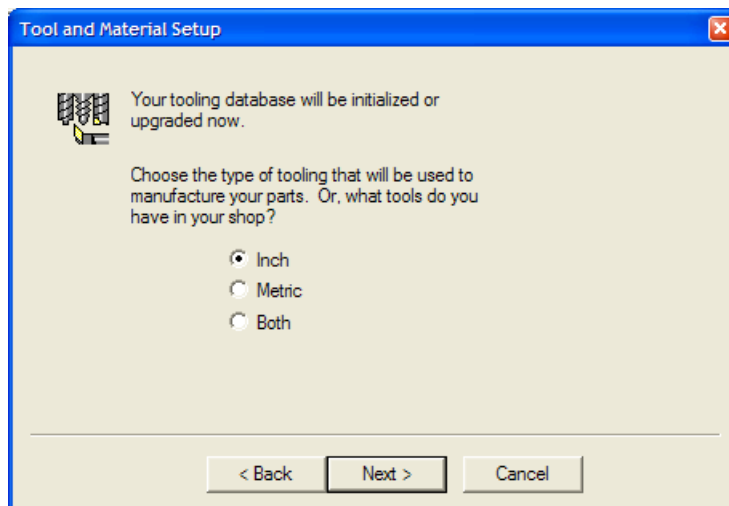

**Inch** - loads only the inch tools.

**Metric** - loads only the metric tools.

**Both** - loads both inch and metric tools.

6. Click the **Next** button to continue.
7. If you chose to load both tool types, you are asked which tool type you use more often. Select **Inch** or **Metric**, and click **Next**.
8. Click **Finish** to initialize the database.



*The tools database specifies the set of tools used by FeatureCAM to perform manufacturing operations. For best results, use the **Tool Manager** (available from the **Manufacturing** menu) to customize the database to reflect the tools in your shop.*

# Opening a part

When you start FeatureCAM, by default, the **New Part Document** wizard is the first thing you see.

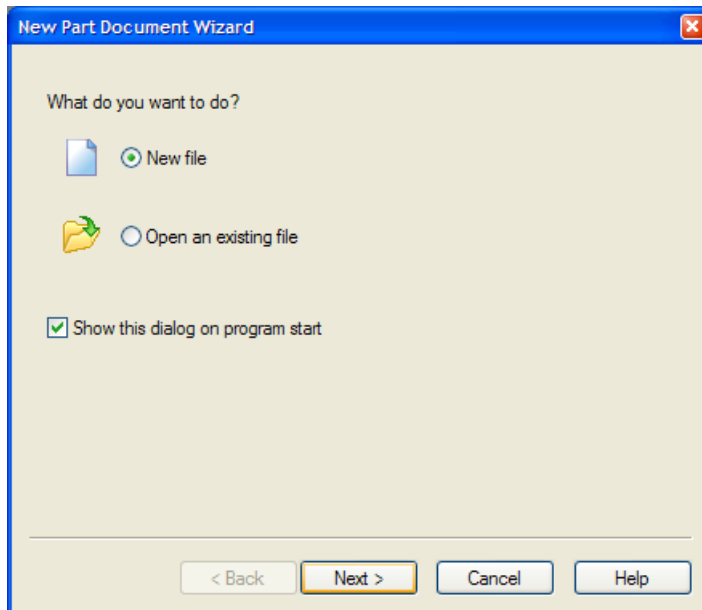

## To open an existing file:

1. Select **Open an existing file** in the **New Part Document** wizard, and click the **Next** button to continue.
2. In the **Open** dialog, select a part file to work with.

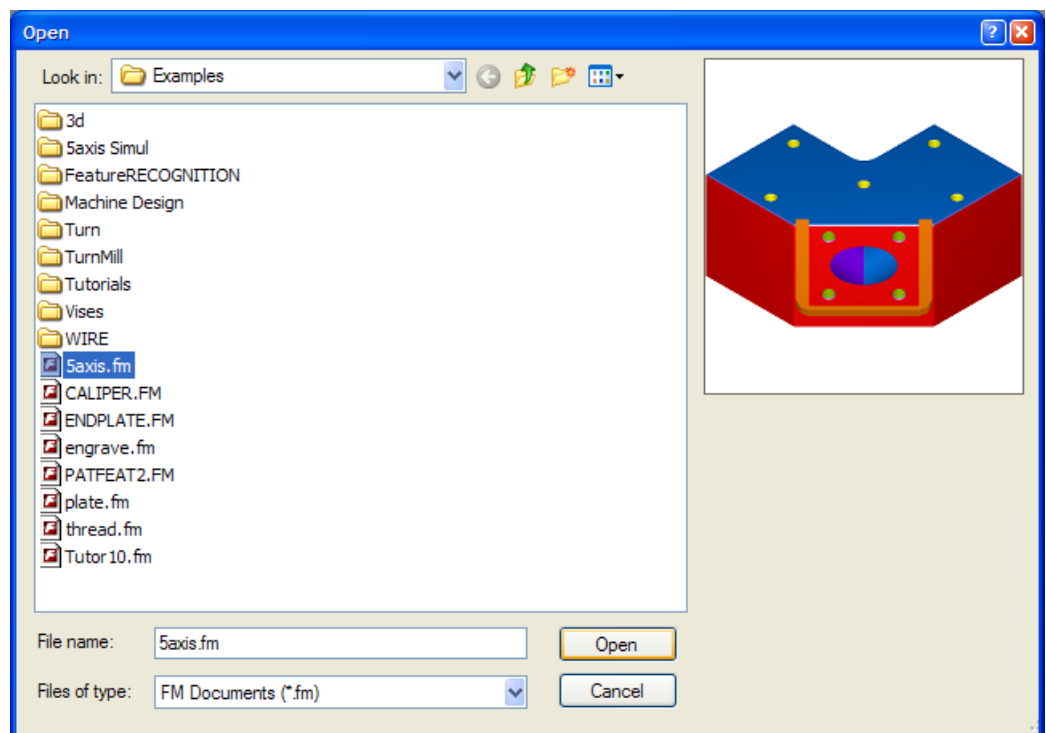



3. When the part file is selected, click the **Open** button to bring up that part in FeatureCAM.



*Double-clicking the part name in the **Open** dialog (or Windows Explorer) automatically selects the part and starts it in FeatureCAM. This works whether you have FeatureCAM running or not. You can also drag-and-drop a part file into the open FeatureCAM **Graphics** window to start a part.*

### To create a new file:

1. Select **New file** in the **New Part Document** wizard, and click the **Next** button to continue.
2. Choose the setup type for your part:

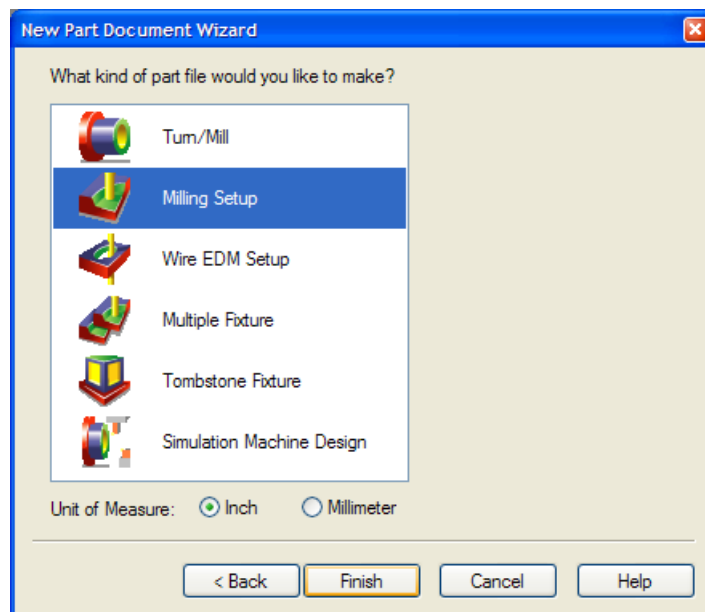

**Turn/Mill** - for turning that supports live tooling.

**Milling** - 2.5D or 3D milled parts. Select this type for 5-axis positioning as well.

**Wire EDM** - for a 2- or 4-axis wire EDM part.

**Multiple Fixture** - for laying out multiple parts on the table. This indicates that you will be mixing different milled parts for multiple part manufacturing.

**Tombstone Fixture** - for parts that you will mass produce on a horizontal or vertical milling machine.

**Simulation Machine Design** - to create a machine tool model for simulation.



*Your choices are limited by the FeatureCAM modules you have purchased.*

3. Select the **Unit of Measure** for your part (**Inch** or **Millimeter**).



*You can change the default dimension units later, by selecting **Options > File Options** from the menu.*

4. Click **Finish**.

---

## Closing the Stock wizard

The stock is the initial material from which you cut your part. By default, the **Stock** wizard (**Dimensions** page) opens on the screen as soon as you have created a new part. It lets you set the shape and dimensions for the stock, the stock material, part program zero, and the coordinate system for modeling.

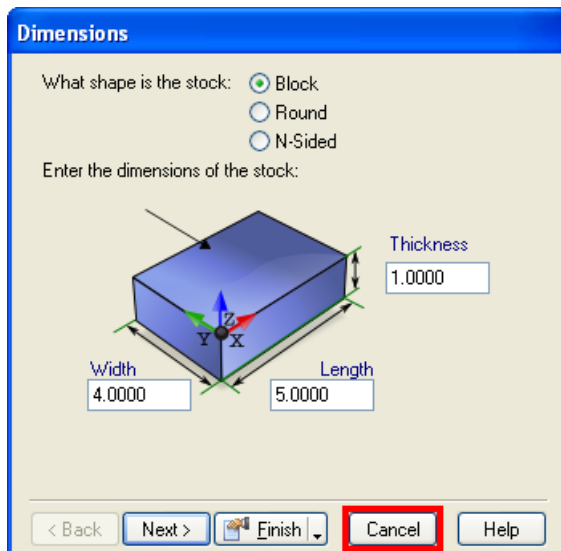

To close the **Stock** wizard, click the **Cancel** button.

---

## Creating a simple part

Let's create a basic part using default FeatureCAM behavior. This tutorial uses the **Milling Setup**. The measurements are in inches; the values in millimeters are shown in parentheses.

1. Create the stock.

- a. Select the **Stock**  step from the **Steps** panel.
- b. In the **Stock** wizard (**Dimensions** page), set **Width** to 4 (100 mm), **Length** to 4 (100 mm), and **Thickness** to 2 (50 mm).
- c. Click the triangle next to the **Finish** button, and select the **Finish** option to exit the wizard.

2. Add a hole feature.

- a. Select the **Features**  step from the **Steps** panel.
- b. In the **New Feature** wizard, select the **Hole** option in the **From Dimensions** section, and click **Next**.
- c. Set **Diameter** to 1 (25 mm), **Depth** to 2 (50 mm), and click **Next**.
- d. Enter the hole location: **X** = 3 (75 mm), **Y** = 3 (75 mm), **Z** = 0.
- e. Click the triangle next to the **Finish** button, and select the **Finish** option to exit the wizard.

3. Add a pocket feature.

- a. Select the **Features**  step from the **Steps** panel.
- b. In the **New Feature** wizard, select the **Rectangular Pocket** option in the **From Dimensions** frame, and click **Next**.
- c. Set **Length** to 2 (50 mm), **Width** to 2 (50 mm), **Depth** to 1 (25 mm), and click **Next**.
- d. Enter the pocket location: **X** = 0.5 (12 mm), **Y** = 0.5 (12 mm), **Z** = 0, and click **Finish**.

4. Select **View > Principal Views > Isometric** from the menu.

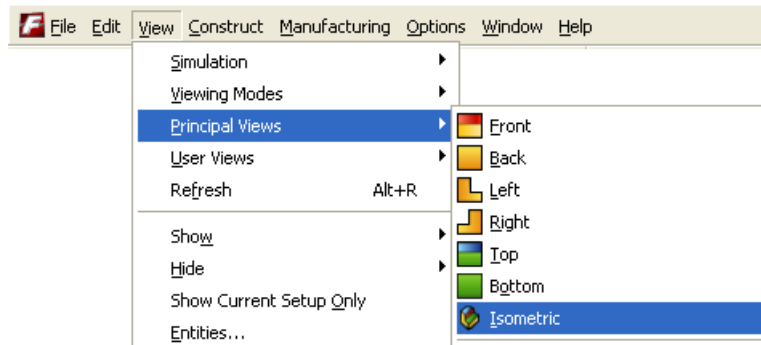





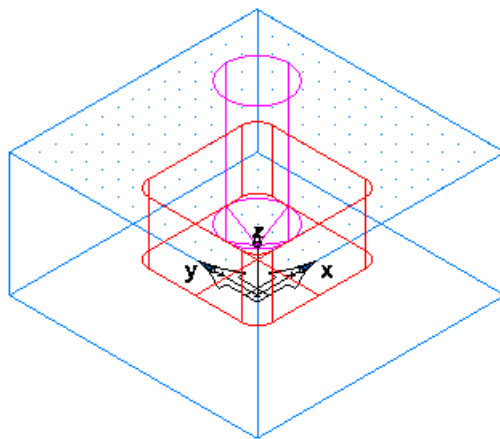

5. Select **File > Save**, and save your part as [first1.fm](#).

Your part should look something like this:



6. Create the toolpaths.

- a. Select the **Toolpaths**  step from the **Steps** panel. The **Simulation** toolbar opens.
- b. Click the **Show Centerline**  button, and then click the **Play**  button. Lines are drawn that represent the center of the tip of the tool. Rapid moves (G0) are shown in green and lines and arcs (G1, G2, and G3) are shown in black.
- c. Click the **3D Simulation**  button, and then click the **Play**  button. This style shows a three dimensional shaded rendering of the initial stock and simulates material removal in 3D. Any gouge caused by holder interference or the tool hitting the part during a rapid move is displayed in pink.
- d. Click the **2D Simulation**  button, and then click the **Play**  button. For milling this style shows a flat (from the top) view of the part, with each tool being shown in a different color. For turning, this style shows a cross section of the part.

7. To view the generated NC code, click the **NC Code** tab in the **Results** window.

You are now ready to take a quick interface tour (see page 15).

---

## Saving your work

### To save a FeatureCAM part file the first time:

1. Select **File > Save** from the menu.
2. In the **Save As** dialog, choose the folder to store your file.
3. Enter the name in the **File name** field. By default, the file is called *FM[N].fm*, where N is an incremental number.



*FeatureCAM automatically appends an **fm** suffix to your part file name - this identifies file as a FeatureCAM file.*

4. Click **Save**.

In FeatureCAM, you have the option of saving a number of previous versions of your part as you work.

### To create a backup copy:

1. Select **Save Options** from the **File** menu.
2. In the **Save Options** dialog, select the **Create Backup Copies** option.
3. Enter the **Number of copies to keep**, for example **1**.
4. Choose the backup location.
5. Click **OK**.

Now when you save your file, the last saved version is saved as Backup of <Filename>.fm in the same location as the original.

# Interface tour

The FeatureCAM interface contains a number of traditional Windows elements, such as toolbars, dialogs, context menus, and wizards.

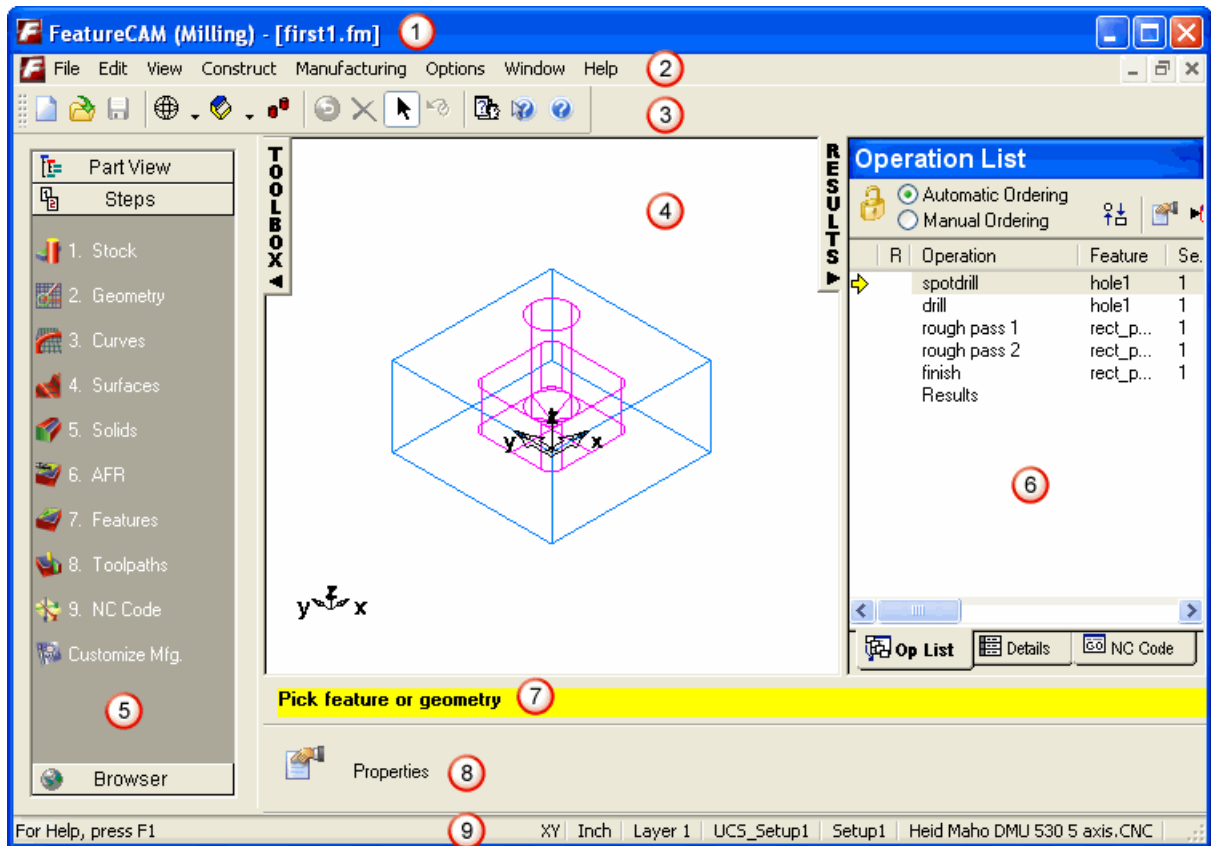

- ① - **Title bar** (see page 16)
- ② - **Menu bar** (see page 16)
- ③ - **Toolbars** (see page 17)
- ④ - **Graphics window** (see page 26)
- ⑤ - **Toolbox** window with the **Steps** (see page 31) panel, **Part View** (see page 45) panel, and **Browser** (see page 47)
- ⑥ - **Results** (see page 49) window
- ⑦ - **Assistance bar** (see page 50)
- ⑧ - **Feature/Geometry Edit bar** (see page 50)
- ⑨ - **Status bar** (see page 50)





As with other Windows programs, you can tell FeatureCAM what to do in several ways:

- Select a button on a toolbar;

- Select an option from a menu;
- Select an option from a context menu;
- Press a keyboard shortcut.

As you master FeatureCAM, try combining several methods of issuing commands to get your work done faster.

## Title bar

Like most Windows applications, FeatureCAM has a **Title** bar at the top. At the left side of the bar is the **control**  icon, and at right side of the bar are three standard icons: **minimize** , **maximize/restore** , and **close** .



*You can maximize the FeatureCAM window on the screen by double-clicking the **Title** bar. To restore its previous size and position, double-click it again.*

The type of part setup is shown in round brackets, for example: **(Milling)**, and the name given to your part file is shown in square brackets, for example: **[first1.fm]**. When you have any unsaved changes in your part file, an asterisk (\*) is displayed next to its name.

## Menu bar

The **Menu** bar contains all commands available in FeatureCAM. Menus are grouped by similar functionality. For example, all commands related to features and geometry are located under the **Construct** menu, all commands related to user assistance are located under the **Help** menu and so on.

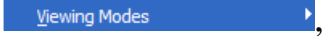
When a menu has a right-pointing arrow, such as , there is a submenu associated with that choice.

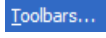
When a menu item is followed by three dots, such as , there is a dialog or a wizard associated with that choice.

You can use the keyboard to navigate around the menus. To do this, press and hold the **Alt** key, and then press the letters on your keyboard that correspond to the letters underlined on the **Menu** bar and in the menu options. For example, to rotate your part, press and hold the **Alt** key, press **V** for **View** menu, press **V** for **Viewing Modes**, and press **R** for **Rotate**.

This manual contains a full list of the keyboard shortcuts (see page 52). Typically, use the **Ctrl**-key shortcuts for standard Windows commands (**Ctrl+N** to create a file; **Ctrl+S** to save a file), and the **Alt**-key shortcuts to execute FeatureCAM-specific commands (**Alt+R** to refresh the view).

## Toolbars

FeatureCAM toolbars provide quick access to frequently used commands. Every button on a toolbar includes a tooltip, which describes the function the button activates. As well as the tooltip, the **Assistance** bar (see page 50) prompts you for the next step in the process. It senses your context, and helps you design geometry and features.

You can rearrange, open and close toolbars:

- To move a toolbar, click the double-dotted line at the edge of the toolbar, and drag it to a different location.
- To open or close toolbars, right-click an empty area next to the last toolbar on the screen, and choose from the list of available toolbars, as shown below:

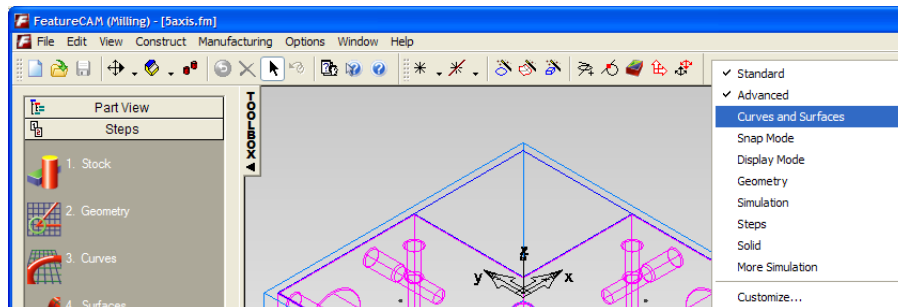

In addition to rearranging the existing FeatureCAM toolbars, you can customize their appearance and content, and create your own toolbars.

If a toolbar button has a down-pointing arrow next to it, such as , a submenu toolbar is associated with that choice. Click the triangle to open the menu, and select a specific option. As you move through the menu, additional help is displayed in the **Status** bar (see page 50). When the option is selected, it becomes the current command and is displayed as a button in the toolbar. To repeat the command, click the button in the toolbar. To choose a different command, click the triangle again.











Some buttons on toolbars let you choose a program mode. For example, to create a circle, you need to be in circle-creation mode. To rotate your part, you need to be in rotation mode and so on. FeatureCAM remains in the selected mode until instructed otherwise. To identify the mode you are in, look at the buttons. A pale gray border around a button indicates that the corresponding mode is currently active.



To leave the mode, usually you need to click the button again.

## Standard toolbar

-  The **New Part Document** button creates a new part file. You can control how files are created by selecting **Options > File Options** from the **Menu** bar, and customizing the settings on the **New Files** tab.
-  The **Open** button opens an existing file. You can control how files are opened by selecting **Options > File Options** from the **Menu** bar, and customizing the settings on the **Existing Files** tab.
-  The **Save** button saves the current file. You can control how files are saved by selecting **File > Save Options** from the **Menu** bar.
-  The **View** menu lets you select viewing modes for your part. Your cursor shows the same icon as the viewing mode you selected.
-  The **Principal View** menu lets you select one of seven predefined views for your part.
-  The **Shade** button toggles display of shaded surfaces for solid modeling. You need to have the Solid Modeling module to use this option.
-  The **Undo** button reverses the effect of the previous command. FeatureCAM remembers a long list of the commands that are performed, so you can undo more than one command.
-  The **Delete** button erases the object that is selected on the screen. The object is removed from the system.



The **Select** button turns on select mode. When you are in select mode, the mouse appears as a standard arrow pointer in the **Graphics** window. In select mode, you can click objects to select them.



The **Transform** button opens the **Transform** dialog, and lets you move or copy the selected entity.



The **Options Dialog** button opens the **Options** dialog, and lets you customize FeatureCAM.



The **Context Help** button switches on context-sensitive help. When the cursor has changed to a question mark (?), click a menu item, button or dialog to receive more information.



The **FeatureCAM Help** button opens online help.

## Advanced toolbar



The **Show** menu contains the object categories that can be displayed in the **Graphics** window.



The **Hide** menu contains the object categories that can be hidden in the **Graphics** window. Hiding objects does not delete them; it only removes them from display.



The **Curve Wizard** button opens the **Curve** wizard and lets you construct curves. The commands available in this wizard are also available from the **Curves and Surfaces** toolbar (see page 20).



The **Surface Wizard** button opens the Surface wizard and lets you construct surfaces. The commands available in this wizard are also available from the **Curves and Surfaces** toolbar (see page 20).



The **Solid Wizard** button opens the **Solid** wizard and lets you construct solids. This option is available if you have the Solid Modeling module.



The **Toggle Geometry Bar** button toggles the display of the **Geometry** toolbar (see page 22).



The **Snap Modes** button opens the **Snap Modes** dialog, which lets you set the locations for point snapping.



The **New Feature Wizard** button opens the **New Feature** wizard, which lets you create features.



The **UCS** button opens the **User Coordinate System** dialog, and lets you create or change existing UCSs.



The **Setups** button opens the **Setups** dialog and lets you create or edit part program zero.

## Curves and Surfaces toolbar



The **Curve** menu lets you use predefined curves, such as ellipses or rectangles.



The **Curve from Curve** menu lets you construct curves from other curves.



The **Curve from Surface** menu lets you construct curves from surfaces.



The **Surface Primitives** menu lets you use predefined surfaces, such as spheres or cylinders.



The **Surface from Curve** menu lets you construct surfaces from curves.



The **Surface from Surface** menu lets you construct a surface from a single surface.



The **Surface from Surfaces** menu lets you construct a surface from multiple surfaces.



*To construct surfaces, you need to have the MILL3D module.*

## Snap Mode toolbar



The **Snap to Grid** button displays a grid and enables snapping to the grid. Selecting **Snapping Grids** from the **Options** menu controls the spacing of the grid. **Grid** snaps to a point on a coordinate system that is laid out on the stock. The grid size can be modified from the **Options** menu.



The **Snap to Point** button snaps to a point object.



The **Snap to End Point** button snaps to the end points of finite lines and arcs; it also applies to the corners of the stock.



The **Snap to Midpoint** button snaps to the middle points of finite lines and arcs.



The **Snap to Section** button snaps equal intervals of a finite line. The number of sections is controlled by the **Sections** parameter of the **Snapping Grids** dialog.



The **Snap to Intersection** button snaps to the intersection of lines, arcs, and circles.



The **Snap to Center** button snaps to circle centers. This setting also controls the display of circle and arc center points.



The **Snap to Quadrant** button snaps to the four points on a circle corresponding to 0°, 90°, 180°, and 270°.



The **Snap to Object** button snaps to a point on another object. This includes lines of surfaces and is convenient for snapping points to locations on a surface.



The **Snap to Tangent** button snaps the point so that the object you are creating will be tangent to the object you snapped to.



The **Snap to Toolpath** button snaps to points on a centerline toolpath simulation.



The **Snapping Discrimination Dialog** button opens the **Snap Discrimination** dialog if the point you select could snap to more than one location.

## Display Mode toolbar



The **Shade Selected** button shades objects selected on the screen. This is the only way to shade features.



The **Unshade Selected** button removes shading from the selected objects, and returns them to line drawings.



The **Unshade All** button returns all objects to line drawings.



The **Hidden Line** button toggles the view of solids to hidden line mode.



The **Draft Hidden Line** button toggles the view of solids to draft hidden line mode.



The **Show Normals** button shows the normals for selected surfaces in the model.



The **Unshow Normals** button hides the normals for selected surfaces in the model.



The **2D Turned Profiles** button shows turning features as 2D profile.

## Geometry toolbar



The **Point** button creates a point at X Y Z coordinates.



The **Line** menu lets you create different types of lines.



The **Circle** menu lets you create different types of circles.



The **Fillet** menu lets you create different types of fillets.



The **Arc** menu lets you create different types of arcs.



The **Dimension** menu lets you create dimensions, or special text labels with attached lines to indicate your part's size.



The **Edit** menu lets you edit selected geometry.



The **Chain** menu lets you construct feature curves from selected geometry.

## Simulation toolbar



The **Eject** button removes the **Simulation** toolbar from the screen, and erases the simulation from the **Graphics** window.



The **Show Centerline** button selects a centerline simulation. When you click the **Play** button, the simulation is performed using the current view to draw the toolpaths. A line drawing representing the center of the tool tip is displayed.



The **2D Simulation** button selects 2D simulation. When you click the **Play** button, a two-dimensional color simulation is performed showing the regions cut by each operation. The view is changed to the top view automatically, and anything on the screen is temporarily erased until the simulation is complete. You can't change the view during the simulation. Once the simulation is complete you can change the view, but the toolpaths are erased.



The **3D Simulation** button selects 3D simulation. When you click the **Play** button, a 3D shaded simulation is performed in the current view with the tool animated through all of its moves. You can dynamically change the view of the simulation at any point during or after the simulation. The simulation does not have to be recalculated, so the view change is instantaneous.



The **3D RapidCut** button selects rapidcut simulation. When you click the **Play** button, a 3D simulation is performed without animating the tool. Only the final results are displayed. For most parts, the simulation takes only a few seconds to complete. This simulation can be viewed dynamically.

This simulation type is available if you have the FeatureCAM3D module; it does not apply to turned parts.



The **Machine Simulation** button selects machine simulation. When you click the **Play** button, a full machine simulation is performed showing you how the machine will cut the part. Odd motions and collisions can be detected so that the program can be adjusted long before code is sent to the CNC machine.

This simulation type is available if you have the Machine Simulation module.



The **Stop** button cancels a simulation.



The **Play** button starts a simulation, or resumes a paused simulation.



This button starts a simulation of the selected feature, or resumes a paused simulation.



The **Pause** button pauses the simulation. It appears on the toolbar when you press the **Play** button. Clicking the **Pause** button transforms it back into the **Play** button.



The **Fast Forward to End** button speeds up the simulation, and fast forwards it to the end.



This button speeds up the simulation of selected feature, and fast forwards it to the end.



The **Single Step** button moves the simulation ahead by one tool move. The keyboard accelerator for this button is **Alt+F3**.



This button moves the simulation of selected feature ahead by one tool move.



The **Simulation Next** menu lets you specify how the simulation is played.



The **Simulation Next** menu lets you select how the simulation of selected feature is played.



The **Clear Toolpath** button erases any centerline toolpaths shown on the screen.



The **Region of Interest** button lets you limit the portion of the part that is rendered during a 3D solid simulation or a rapidcut simulation.



The **Show Tool Load** button displays the **Tool Load** dialog when the next 3D simulation is played. This dialog graphs the horsepower requirements of the part program, and displays the current simulation time and instantaneous horsepower.



The **Sim Speed** slider is used to adjust the simulation speed. Moving the bar to the right speeds up the simulation; moving the bar to the left slows it down.

## Steps toolbar



The buttons on the **Steps** panel (see page 31) in the **Toolbox** window are also available as the **Steps** toolbar.



*Display this toolbar if you want to use the **Part View** panel (see page 45), but need an easy access to the buttons on the **Steps** panel.*

## Solid toolbar



The **Solid from Curve** menu lets you construct solids from curves.



The **Solid from Surfaces** menu lets you construct solids from surfaces.



The **Modify Solid** menu lets you edit solids.



The **Manufacturing Solids** menu lets you select a manufacturing category.

## More Simulation toolbar



This button toggles the display of the **Simulation** toolbar (see page 22), and lets you preview the toolpaths from start point.



This button toggles the display of the **Simulation** toolbar, and lets you preview the toolpaths for selected Z level.



This button toggles break points in the simulation at toolpath level.





This button toggles break points in the simulation at Z level.



## Graphics window

The **Graphics** window is your main working area. It shows the graphical representation of the part, and the graphical toolpath simulations.

You can control how much space the **Graphics** window uses compared to the **Toolbox** and the **Results** windows by moving the sliders  from side to side. Alternatively, try expanding and collapsing the **Toolbox** and the **Results** windows by clicking the corresponding  and  icons.



*In most cases, right-clicking in the **Graphics** window displays a context menu with some options for the current situation.*

## Mouse buttons

The left, middle, and right mouse buttons have specific uses in FeatureCAM.

- Left mouse button selects objects, such as geometry, interface objects (buttons, tabs), and objects in the **Part View** panel.
- Middle mouse button is used to dynamically view objects in the **Graphics** window. By default, holding the middle mouse button as you drag the mouse zooms the view. Using the **Ctrl** key and the middle mouse button rotates the view. Using the **Ctrl+Shift** keys and the middle mouse button pans the view. You can customize the middle mouse behavior by selecting **Options > Viewing** from the menu.
- Right mouse button activates context-sensitive menus. For example, positioning the mouse cursor over the **Steps** panel, and right-clicking lets you customize the look of the buttons on the **Steps** panel.

## Mouse cursor

The cursor shape may change to indicate the mode that is currently selected.

In select mode, the cursor arrow indicates what you are selecting, or what the system expects you to select:





 - **Part View** panel.



 - **Steps** panel.

 - area that you can expand/collapse on the screen.

 - editable area on the **Status** bar.

 - stock.

 - feature.

 - geometry (point).

 - geometry (line).

 - geometry (circle, arc).

 - geometry (fillet).

 - geometry (dimension).

 - geometry (surface).

In view mode, the cursor takes a shape of the chosen option, showing you what you can do with the part:

 - rotate along the X and Y axes.

 - trackball.

 - pan, that is move around without changing the magnification. The part is moved perpendicular to the viewing angle.

 - zoom, that is change the display magnification. Moving the mouse to the right enlarges the part, moving the mouse to the left shrinks the part.

 *You can also zoom in and out using the mouse wheel.*

 - zoom to a box (selected area). The selected portion of the drawing is enlarged to fill the **Graphics** window.

 - pan and zoom. The point where you click is centered on the screen, and then the part is zoomed with the mouse movement.

 - rotate along the X axis.

 - rotate along the Y axis.

 - rotate along the Z axis.

In geometry mode, the cursor changes to crosshairs . A number next to the cursor indicates the progress of the shape construction, for example, a construction of an arc, requires creating three points.

When you use snap mode, a small snap icon shadows the cursor. When snapping to a circle center, endpoint, midpoint, quadrant or section, the snap icon is a small box:



When snapping tangent to a circle or arc, the icon is a small circle that can slide along the circle or arc while maintaining tangency:



Snapping to a grid point, the icon is a small plus sign:





When snapping to an object, the icon is a large dot:



When you chain geometry, your mouse cursor looks like a target point: 

## Smart dialogs

To provide you with more space in the **Graphics** window, FeatureCAM automatically minimizes some dialogs by default. For example, the **Select Stock Curve** dialog minimizes into a small title bar when you click the **Pick Curve**  button.

When the dialog is minimized, the cursor shape changes to . This indicates you need to select an object in the **Graphics** window. When you select the object, the dialog is restored. If you want to restore the dialog without making a selection, click the  button in the small title bar.

 *To disable auto-minimization, deselect **Options > Warp Dialogs** in the menu.*

## Selecting graphical objects

Select mode is chosen by default. If you need to switch it on, click the **Select**  button on the **Standard** toolbar.

To select objects in the **Graphics** window you can:

- Click the left mouse button on an object. This selects that object (by turning it red) and deselects any other object.
- Hold down the **Shift** key and click the left mouse button on an object. This adds that object to the selected set of objects. This method allows you to select more than one object.
- Click the left mouse button and drag the mouse before releasing the button. This method is called **box select**. As you drag the mouse, a box is displayed in the **Graphics** window. All objects that are completely enclosed in the box are selected. If you hold down the **Shift** key while selecting, the objects are added to the selected set of objects.

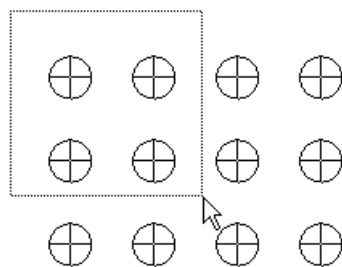

## Viewing and shading your part

### Viewing

Viewing is performed interactively in FeatureCAM with the mouse. You can choose a number of viewing options from the **View** menu on the **Standard** toolbar. By default, each viewing command executes only once. To stay in the selected viewing mode, press the **Ctrl** key on your keyboard as you click the viewing command. The selected viewing option is now active until you deselect it on the toolbar.



*Once you've selected a viewing option, you can activate it again, by holding the **Shift** key and pressing the right mouse button.*

Instead of zooming and panning to position your part, you can choose one of the pre-defined view from the **Principal View** menu on the **Standard** toolbar. You can also create up to four **user views**, and return to them to compare different aspects of your part.



*To create a user view, position the part in a view you will want to return to, and select **View > User Views > Save View**.*

## Shading

By default, everything that you create in FeatureCAM is displayed as a line drawing, for example:



Objects can also be viewed as:

3D shaded drawings



3D hidden line drawings



To control the current display mode, use the **Display Mode** toolbar.

## Deleting objects

There are many ways to delete geometry, curves, surfaces and features:

- Right-click the object in the **Graphics** window and choose the **Delete** option from the menu.
- Select the object in the **Graphics** window, then press the **Delete** key on your keyboard.
- Select the object in the **Graphics** window, then choose **Edit - Delete** from the **Menu** bar.
- From the **View** menu, choose **Entities**, select the object row in the **Entities** dialog, and click the **Delete** button.

## Steps panel

The **Steps** panel contains an ordered list of steps for creating part programs. Each step is a wizard that presents a series of dialogs for each process. They are listed in the order in which you should use them during the process of creating a part program. The flowchart below illustrates this process.

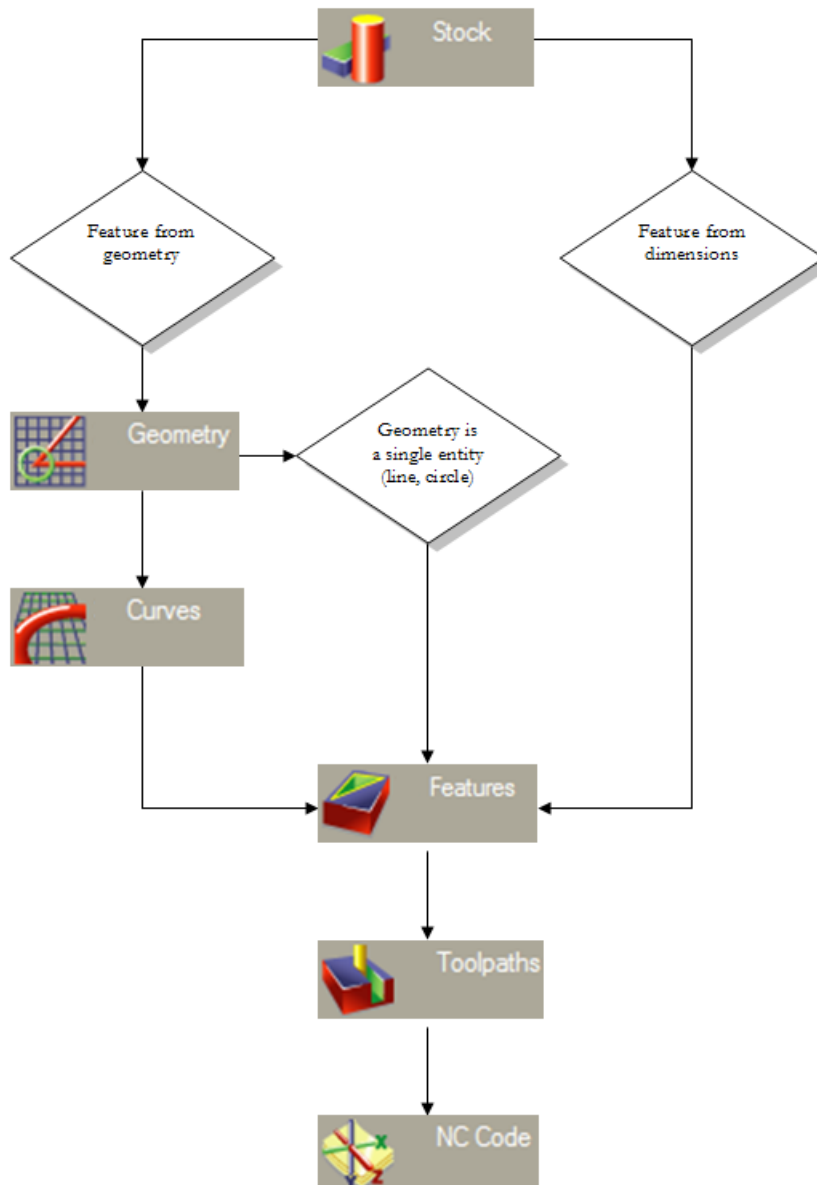

**Step 1: Stock** (see page 32). The **Stock** wizard steps you through entering the shape and dimensions of the stock, the stock material, part program zero and the coordinate system for modeling.

**Step 2: Geometry** (see page 33). Points, arcs, lines and other shapes are used to describe the overall shape of parts. Many different geometry tools are available. Geometry can also be imported from CAD systems.

**Step 3: Curves** (see page 34). Shapes that involve more than a single line or arc are described as curves. For MILL3D customers, there are also **Surfaces** and **Solids** steps for creating 3D surface and solid models.

**Step 4: Features** (see page 35). Features are common shop terms like pocket, or thread. They are created from curves and dimensions. These objects describe your part in 3D and are used to generate toolpaths.

**Step 5: Toolpaths** (see page 36). Toolpaths are generated from collections of features. You can simulate them in FeatureCAM using toolpath centerlines, 2D shaded or 3D solid shaded simulations.

**Step 6: NC Code** (see page 39). Machine-specific G-codes are generated from the toolpaths. Translators are provided for many different NC controls and include a program for creating new translators.

**Customize Manufacturing** (see page 39). FeatureCAM automates the entire part programming **process**, you can customize all of the system settings including feed/speed tables, tooling databases or feature settings.



*If you have 3D, Solid Modeling and RECOGNITION modules, the **Steps** panel may include extra steps (see page 44).*

## Step 1: Stock

The stock is the initial material from which you cut your part. It can be rectangular, circular, a more general extruded shape, or a solid model. The stock shape is used for 3D toolpath simulations and to control the extent of milling features like bosses.

FeatureCAM has embedded feed/speed tables for many different stock materials, so that feeds and speeds can be automatically calculated based on the stock material.

The **Stock** wizard provides step-by-step instructions for specifying or modifying the general stock shape, specific stock dimensions, fixture IDs, part program zero, and the origin of your modeling coordinate system.

To navigate through the wizard, enter the desired information on each page and click the **Next** button to move to the next page.

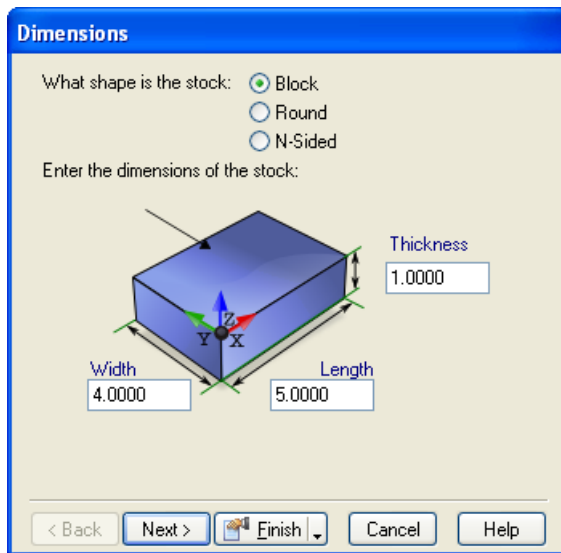

After completing this step, if you want to create holes, rectangular pockets, slots, circular pockets, or thread mill features, you can skip to **Step 4: Features** (see page 35).

## Step 2: Geometry

Each part starts with an initial design. You may already have a part drawing, a part sketch or you may want to use FeatureCAM to draw your part design from scratch. The geometry step gives you methods of creating points, lines, arcs, and circles. You can also clip geometry.

If you want to create multiple objects, select the **Create more than one** option at the bottom of the **Geometry Constructors** dialog before selecting the type of object you want to create.

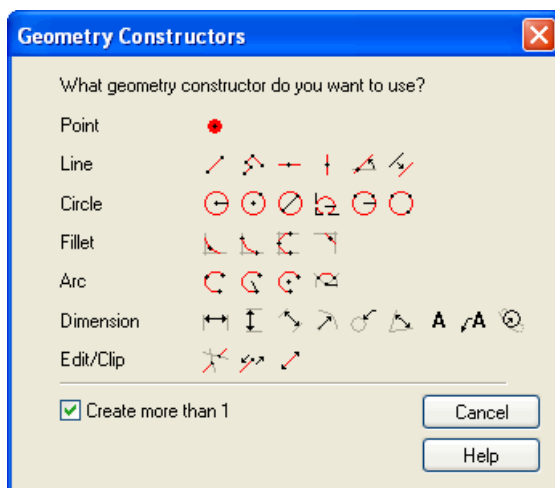



After selecting the type of object you want to create, you see instructions in the yellow **Assistance** bar at the bottom of the screen. Enter any numeric arguments that are required. Use the **Tab** key to move to the next field. For point coordinates, either type the individual X, Y and Z coordinates, or use the mouse to graphically locate them in the **Graphics** window.

As you move the mouse around the **Graphics** window, the cursor snaps to discrete locations like circle centers or line endpoints. You control this location using the **Snap Mode** toolbar (see page 20). Alternatively, you can select **Options > Snapping Modes** from the menu, and use the **Snap Modes** dialog.

### Step 3: Curves

This step groups arcs and lines into curves by automatically tracing smooth paths. If you want to make a feature from more than a single line, arc or circle, you must connect the geometry into a curve.



This option creates closed curves (curves that form a loop) by clicking on one piece of geometry. An attempt is made to create a closed loop by following smooth paths.

If this method does not result in the correct pieces, click the **Clear Pieces** button in the **Feature/Geometry Edit** bar, select the **Curves** step again, and use the **Pick Curve Pieces** command.



This option creates curves by manually clicking on segments of the curves. To create an open curve (curves that do not form a loop), click the beginning of the curve and then click the end. If the resulting curve is not correct, click a number of intermediate positions to guide the process of creating curves. Closed curves can also be created with this technique by clicking back to the initial piece of geometry.



This option opens the **Curve** wizard that provides step-by-step instructions for creating curves using a variety of methods.



This option lets you create curves using the projection of straight walled vertical surfaces. This method is only available if you have a licensed RECOGNITION module.

## Step 4: Features

These are examples of features:

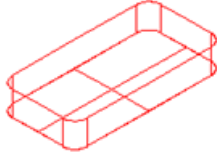
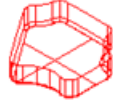
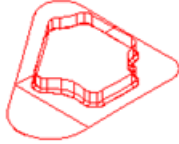
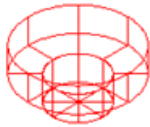
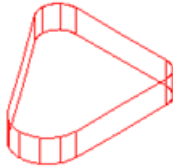
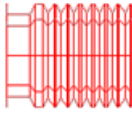
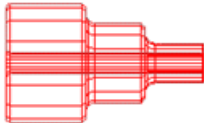
<b>Hole</b>	<b>Rectangular pocket</b>	<b>Pocket</b>	<b>Boss</b>
			
<b>Step bore</b>	<b>Side</b>	<b>Turned groove</b>	<b>OD turning feature</b>
			

Toolpaths are generated from features. For example, if you want a hole in your part, choose the **Hole** feature. If your part has a pocket, choose the **Pocket** feature. The **New Feature** wizard walks you through the process of creating features.

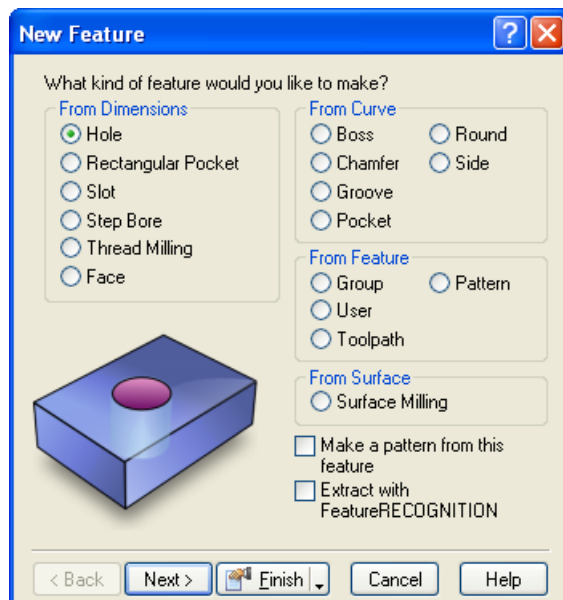

One category of features is those that can be created solely from dimensions. These features include holes, rectangular-shaped pockets, threads, and round pockets (called step bores).

Other features require curves to describe their shape. They are listed under the **From Curve** category. These features include pockets, bosses, grooves, chamfers, rounds, sides, and faces.

If you want to create a pattern of features, select the **Make a pattern from this feature** option. Click **Next** to step through the wizard.

This wizard steps you through:

- Selecting the feature type.
- Optionally entering pattern dimensions.
- Positioning the feature.
- Specifying the manufacturing strategy.
- Reviewing the automatically selected tools.
- Reviewing the automatically calculated feeds and speeds.
- Overriding the tooling and feed/speed values.
- Changing manufacturing attributes.

To modify a feature either **double-click** on it or select it and click the **Properties** button to open the **Properties** dialog. The dialog presents the pages of the **New Feature** wizard in a single dialog. The individual pages are separated into different tabs of the dialog.

## Step 5: Toolpaths

This step displays the **Simulation** toolbar. This toolbar has two sections, simulation types and simulation controls.



### To run a simulation:

1. Select the mode of simulation you would like to run from:
  - **Centerline** simulation displays lines that represent the center of the tool:

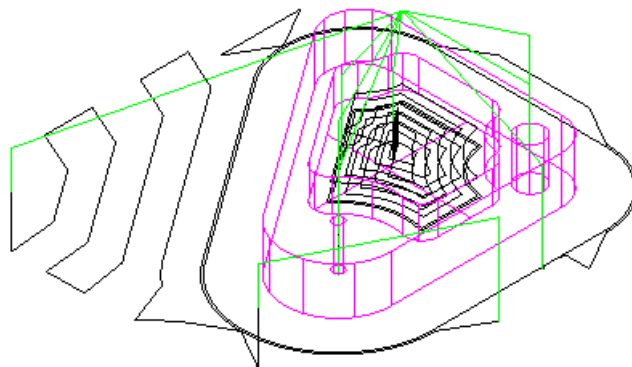

- **2D** shows a color simulation from the top view. Each operation is displayed in a different color:



- **3D** shows a 3-dimensional solid shaded simulation:

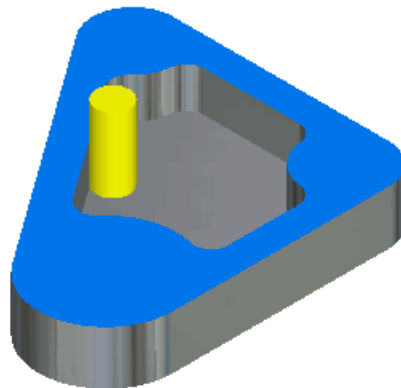

- **RapidCut** displays the final result without animating the tool. This option only applies to MILL3D module.

- **Machine** simulation displays the entire machine. This option is only available if you have the Machine Simulation module.

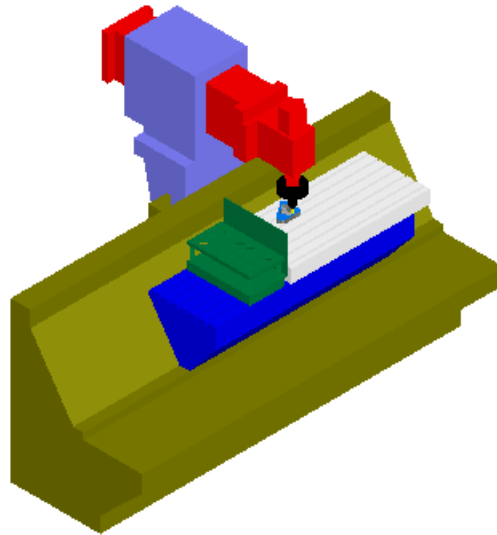

2. Use the simulation controls to control the simulation:

Click the **Play** button to run the simulation. After clicking the **Play** button, this button turns into the **Pause** button. Click this button again to pause the simulation.

The **Single Step** button will display one toolpath move. The **Fast Forward to End** button, displays all the toolpaths for the part without animating the results. You can then view the toolpaths for each individual operation by clicking the **Clear** button and then clicking on an operation in the **Operation List** window.

The **Play to Next Operation** button will display one complete operation such as a spot drill or a pocket roughing operation. This button is actually a menu. By clicking on the triangle to the right of the button the following additional options are revealed:

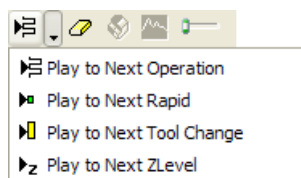

The **Next Rapid** button simulates up to the next rapid move.

The **Next Tool Change** button simulates up to the next tool change.

Play to **Next Z Level** displays the next Z level of a Z level rough or finish operation.

Use the **Erase** button to erase the centerline toolpaths on the screen. The **Region of Interest** is used to limit the portion of the part that is simulated for **3D** or **Rapid Cut** simulations. The **Show tool load** button indicates whether to display a graph of the tool load when the next 3D simulation is performed. The **Eject** button removes the toolbar and the simulation from the screen. The speed control slider controls how fast simulations run. Move the slider to the right to speed up, or to the left to slow down.

3. If you see something in the simulation you want to change, you can override any of the tool choices, operation order, or the feeds and speeds if you wish. Continue to simulate and fine-tune the part until you have the settings exactly right.

## Step 6: NC Code

You generate NC code in FeatureCAM using this step. The **NC Code** dialog opens.



The **Feed Optimization** button evens out the load on the tool by adjusting the feedrate of each NC block.



The **View the NC Code** button displays the code in the **Results** window. You can also display the tooling lists and operations sheets by clicking the tabs located at the bottom of the **Results** window.



The **Save NC** button opens the **Save NC** dialog and lets you save the NC code to disk. You can also save additional documentation like tool lists, operations lists and part databases.



The **Tool Mapping** button lets you change the locations of the selected tools in the tool changer.

## Customize manufacturing

This step lets you customize the tools and materials databases, post options, and the default system parameters. The **Customize Manufacturing** dialog opens.



The **Machining Attributes** button lets you configure machining preferences (see page 40).



The **Create tools and manage tool crib contents** button lets you configure the tools database (see page 42).



The **Feeds/Speeds and Cutting Data Tables** button lets you configure the materials database (see page 43).



The **Post Process Options** button lets you customize post options (see page 44).

### *Machining preferences*

Machining preferences, or attributes, control the way a feature is manufactured. FeatureCAM has two types of attributes:

- **Default** - specify the defaults for values such as stepovers, ramping, canned cycle use, or operation ordering. These settings are used for all features that you create.

To modify the default attributes, select the **Customize Mfg.** step on the **Steps** panel, and click the **Set default feature attributes**  button in the **Customize Manufacturing** dialog. This opens the **Machining Attributes** dialog.

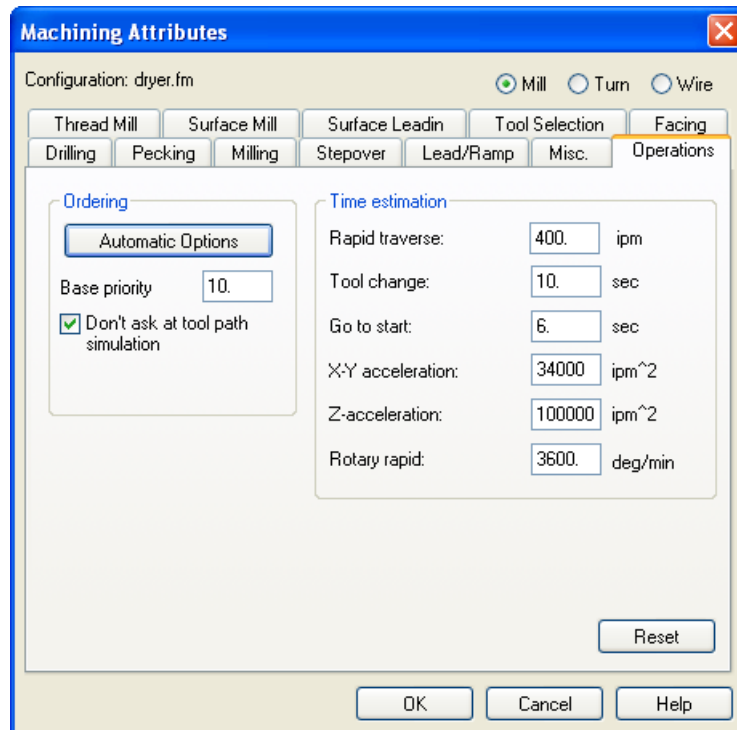

The configurable attributes are divided into three categories: **Milling**, **Turning**, and **Wire**. Select a option, and then modify the settings as desired. The settings are saved with the FeatureCAM file.

- **Feature** - apply to specific features, and override the default settings. For example you may set a default setting for climb milling, but override it for bi-directional roughing for a particular feature.

To set feature attributes, select the feature in the **Graphics** window, and click the **Properties** button located below the **Assistance** bar.

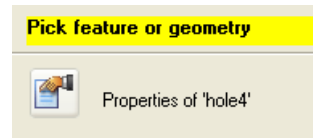

This opens the **Properties** dialog. Click on an operation in the tree view, to display tabs that are specific to the operation. Use this dialog to adjust the settings for the selected feature.

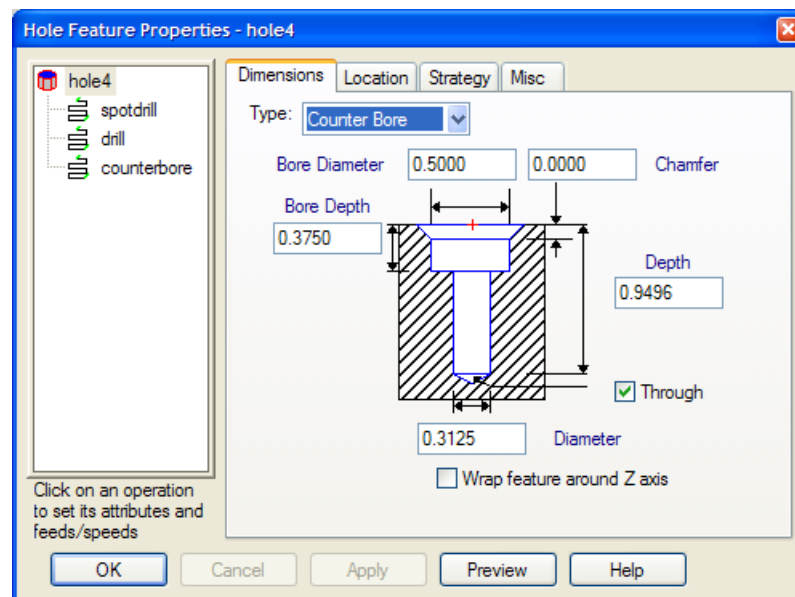



## Tools database

FeatureCAM supports all the tool types in your shop including drills, taps, reamers, end mills, boring bars, and face mills. Each tool type is described by a series of dimensions. Tools are grouped into tool cribs.

FeatureCAM provides a comprehensive tools database and creates a basic tool crib for inch, or millimeter tools, or both. FeatureCAM selects tools from the active tool crib to manufacture the part. You can pick the tool crib you want to use for each part or machine.

You can also create custom tool cribs with the **Tool Manager** to reflect the tools owned by your shop or to exactly represent the tools preloaded in your tool changer.

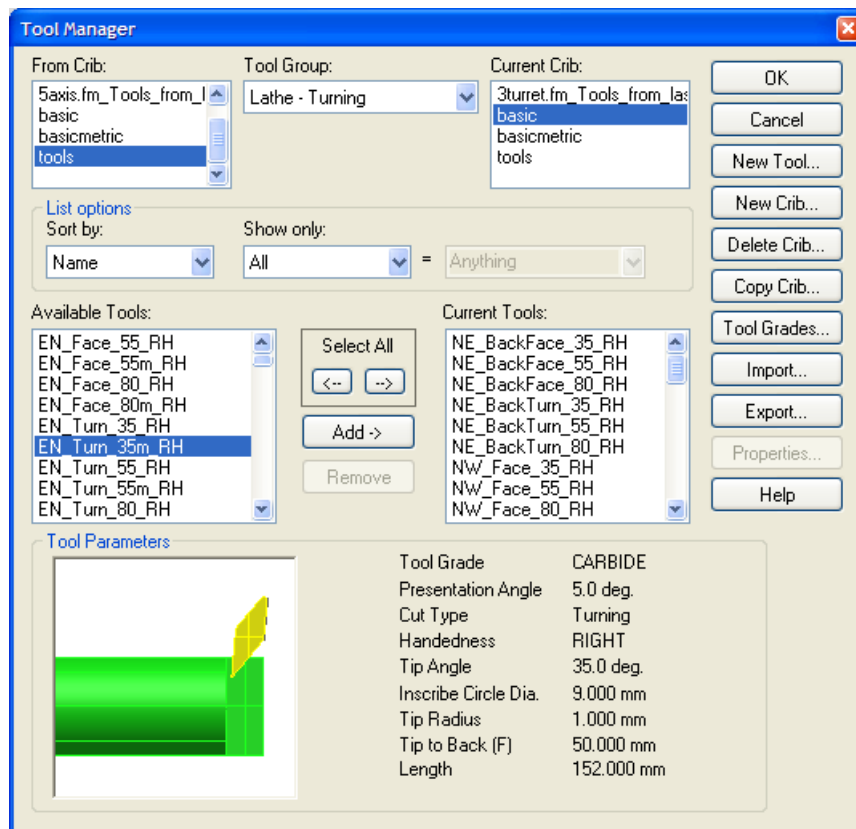

## Materials database

FeatureCAM comes standard with an integrated materials database. Feeds and speeds are stored in tables for each material. Each table contains the settings for different cutting operations. These tables can be customized to change the values or you can add tables for new materials.

Feeds/Speeds And Cutting Data Tables

Stock Material  
Material: ALUMINUM

Use Range

OK  
Cancel  
Delete  
Copy Values...  
Import...  
Export...  
Help

Milling | Drilling | Turning | Wire EDM

Tool Grade: HSS | Tool Finish: BRIGHT

	Profile	Slot	Face	Plunge Mill	
<b>Speeds</b>					
Rough	650.0	435.5	1040.0	793.3	SFM
Finish	1000.0	670.0	1600.0		SFM
<b>Feed (For 1 in. tool)</b>					
Rough	0.0100	0.0067	0.0100	0.0070	IPT
Finish	0.0060	0.0040	0.0060		IPT

## Post options

FeatureCAM has many post processors built-in. To tell FeatureCAM, which one you want, use the **Post Options** dialog. It lets you customize various settings for milling, turn/mill, or Wire EDM posts.

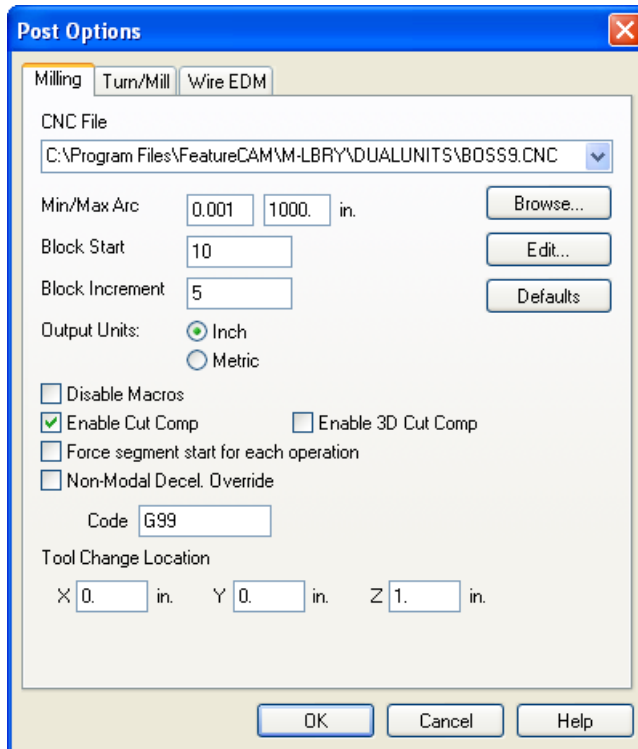

## Optional steps



- **Surfaces**. This step is available in MILL3D. This step launches the **3D Surface** wizard which steps you through creating surfaces from curves, primitive surfaces, surfaces from one surface, and surfaces from multiple surfaces.



- **Solids**. This step is available in the Solid Modeling option. The **Solids** step initiates the **Solids** wizard which helps you create solids using numerous techniques.



- **AFR**. This step is available in the RECOGNITION option. AFR stands for Automatic Feature Recognition. This step automatically recognizes features from solid models.





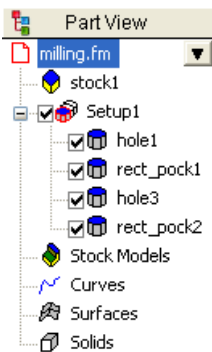



## Part View panel

The **Part View** panel provides a hierarchical view of the part.



Each setup is listed with each of the feature of the setup listed underneath. From this view you can select, show, hide, or modify features.

All objects are represented in the part view with the exception of geometry. When you click on an object in the **Part View** panel, its icon is highlighted in red, for example .

-  **Part** icon represents the entire part. The part filename is also displayed in the tree view.
-  **Stock** icon represents the part stock.
-  **Setup** icon represents a setup. The features of a setup are listed underneath a setup. If you click a setup, it changes the current setup and current UCS.
-  **Feature** icon represents features. It can be a 2.5D, 3D or turn feature. The check box next to the feature can be used to exclude it from toolpath generation. The feature is not deleted; it is just ignored for toolpath generation.
-  **Pattern** icon represents patterns. It can be linear, radial, rectangular, or points pattern. Patterns lets you quickly create the same feature at multiple locations. The check box next to the pattern can be used to exclude associated features from toolpath generation. The feature is not deleted; it is just ignored for toolpath generation.
-  **Curve** icon represents a curve in the part model.
-  **Surface** icon represents surfaces. Surface milling features are classified as features, not surfaces.
-  **Solid** icon represents a solid. Individual design features are listed underneath.

 **Turret** icon represents a turret on a lathe. Selecting a specific turret displays the NC code for that turret.

To navigate the Part View tree:

- If an object has a **+** in its left margin, click it to expand the view to reveal objects that are subordinate. Click the **-** to collapse the view and hide the subordinate objects. Double-clicking on the object also performs the same function.
- Clicking on an object in the tree view will select the object in the **Graphics** window. This selection method is good for distinguishing between overlapping objects in the **Graphics** window. Make sure you click the name and not the check box.
- Clicking on an object also reveals the  button for that feature. Clicking this button brings up a menu of actions you can perform on the object. The actions available are dependent on the object type. Right-clicking on the object in the tree view also reveals this menu.
- Features have check boxes. Deselecting the check box excludes the corresponding object from the next toolpath generation.
- You can reorder these items by dragging a feature or setup.
- Double-clicking on a feature displays its **Properties** dialog for editing.

## Browser

The **Toolbox** contains a **Browser**.

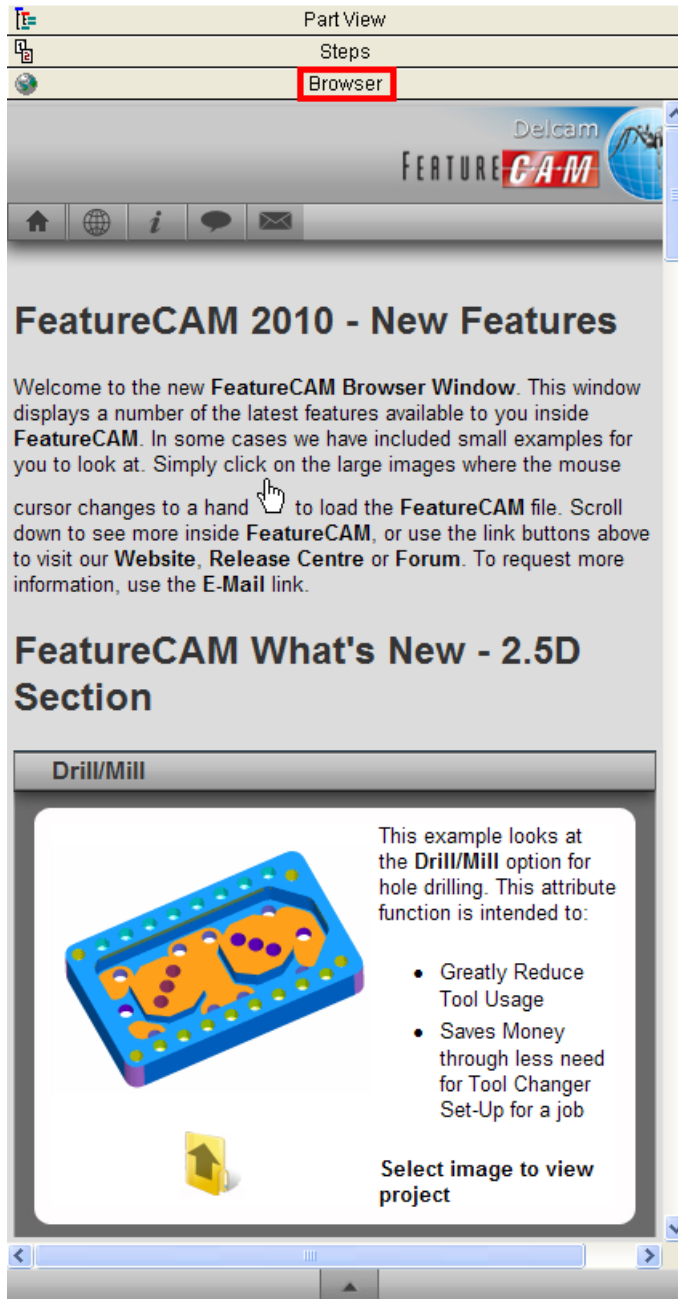

To open the browser, click the **Browser** tab inside the **Toolbox** window.

The **Browser** contains information on the latest features available in FeatureCAM, including example files that you can load straight into FeatureCAM. To load an example project from the **Browser**, click the preview picture.





Click the **Folder**  icon to open a folder containing more files.

 To make the **Browser** wider, hover over the **Toolbox** border until the cursor changes to  $\pm$ , then click and drag the border outwards.



## Browser buttons

The **Browser** contains the following buttons at the top:

-  **Home** - Click to go home to the default Browser home page.
-  **Website** - Click to open the FeatureCAM website (www.featurecam.com).
-  **Release Center** - Click to open the FeatureCAM Release Center website (releasecenter.featurecam.com).
-  **Forum** - Click to open the FeatureCAM user forum (forum.featurecam.com).
-  **Email** - Click to email Delcam about non-support-related issues, or if you don't have the email address of your reseller.

 You may need to go back to the top of the page to see these buttons by scrolling or using the **Top** button detailed below.

And the following button at the bottom:

-  **Top** - click to go to the top of the current page.

## Context menu

Right-click inside the browser to open a context menu that includes the following items:

- Back** - the Browser returns to the previous page that you viewed.
- Select All** - selects all the content on the Browser's current page.
- Print** - prints the Browser's current page.

**Refresh** - reloads the page to include any changes that have been made to the page.

## Results window

The **Results** window contains the automatically generated documentation including tooling lists, setup sheets, and the NC part programs. Selecting one of the tabs at the bottom of the window changes the content of this window.

### Op List tab

The Operation List tab contains a table with manufacturing operations for your part.

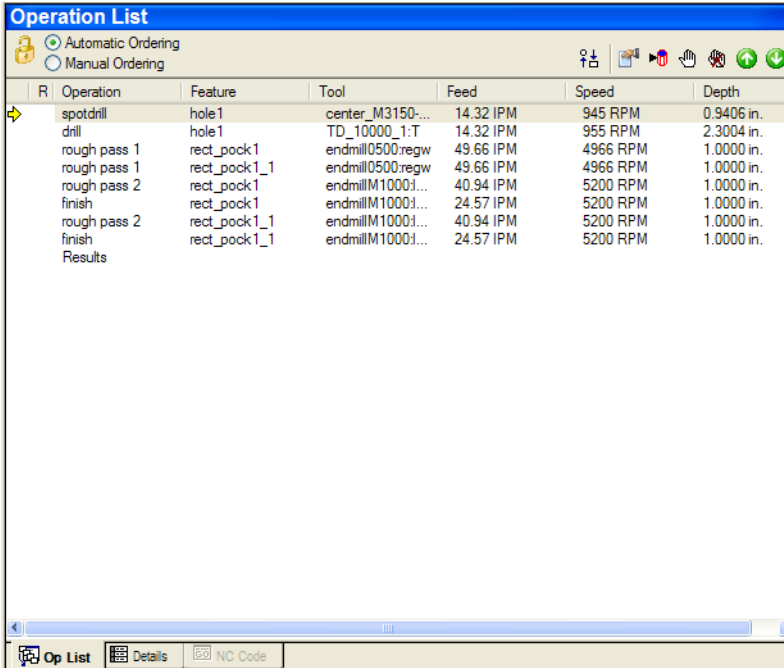

The screenshot shows the 'Operation List' window with a table of manufacturing operations. The table has columns for 'R', 'Operation', 'Feature', 'Tool', 'Feed', 'Speed', and 'Depth'. The current operation is highlighted with a yellow arrow in the 'R' column.

R	Operation	Feature	Tool	Feed	Speed	Depth
	spotdrill	hole1	center_M3150-...	14.32 IPM	945 RPM	0.9406 in.
	dрил	hole1	TD_10000_1:T	14.32 IPM	955 RPM	2.3004 in.
	rough pass 1	rect_pock1	endmill0500:regw	49.66 IPM	4966 RPM	1.0000 in.
	rough pass 1	rect_pock1_1	endmill0500:regw	49.66 IPM	4966 RPM	1.0000 in.
	rough pass 2	rect_pock1	endmillM1000j...	40.94 IPM	5200 RPM	1.0000 in.
	finish	rect_pock1	endmillM1000j...	24.57 IPM	5200 RPM	1.0000 in.
	rough pass 2	rect_pock1_1	endmillM1000j...	40.94 IPM	5200 RPM	1.0000 in.
	finish	rect_pock1_1	endmillM1000j...	24.57 IPM	5200 RPM	1.0000 in.
	Results					

Each row displays the operation, feature that the operation came from, and the tool that will be used to cut the feature. As the toolpaths are simulated, the current operation is indicated with a yellow arrow in the left-hand margin. To edit a feature, double-click the corresponding row. If a manufacturing error is detected, a warning ⚠ sign is displayed in the left-hand side of the row. Double-clicking on the icon takes you to the description of the problem on the **Details** tab.

### Details tab

The **Manufacturing Details** tab contains two sheets:



- **Operations List** lists the cut type, cut depth, center point, tool details, speed/override, feed/override and estimated manufacturing time for each manufacturing step.
- **Tool List** provides in-depth information for the tools used to manufacture the part, including tool name, tool slot or tool pocket number, tool offset number and so on.

To view a sheet, select the corresponding options.

## NC Code tab

This tab contains the generated NC code for your part. The tab appears when you select the **NC Code** step from the **Steps** panel. If you select the **NC Code** step before you have generated toolpaths, FeatureCAM prompts you to create the toolpaths, and then opens the **NC Code** tab.

## Assistance bar

The yellow **Assistance** bar displays step-by-step instructions for the current command.

## Feature/Geometry Edit bar

The **Feature/Geometry Edit** bar is located below the **Assistance** bar. It is context-sensitive, and lets you select and edit a feature, or enter the point locations and parameters for geometry creation.

## Status bar

The **Status** bar appears at the bottom of the FeatureCAM screen. It shows your current drawing units, toolcrib, and post processor settings, as well as your keyboard status and information about the simulation when you run one.



*This is not a toolbar; you can't move it around, but you can turn it on and off by selecting **View > Toolbars** from the menu and using the check box in the **Misc** tab. You can also customize the simulation information by going to **Options > Simulation**, and selecting the options in the **Status** frame for all items that you want to be displayed.*

The **Status** bar contains:

**Cursor coordinates** - the current X Y Z location of the cursor in the **Graphics** window.

**Grid coordinates** - the grid point X Y location of the cursor in the **Graphics** window.

### **Drawing units**

**Layers** - the currently active layer. You can change the layer by double-clicking it here.

**User Coordinate System (UCS)** - the currently active UCS. UCS is an origin and three vectors (X, Y, and Z) that determine a position and orientation in 3-dimensional space. You can use an unlimited number of these to conveniently model your part. To change the currently active UCS, double-click its name.

**Setup** - the currently active setup for your part. A setup is an orientation and part program zero for a physical setup on the machine tool. You change the setup by double-clicking its name.

**CNC file** - the currently selected CNC file. Double-clicking it opens the **Post Options** dialog, and enables you to change the settings.

**Toolcrib** - currently active toolcrib (set of tools in the tooling database). You can change the toolcrib by double-clicking its name.

### **Keyboard status**

**Simulation information**, such as tools, feeds/speeds, elapsed time.

---

## **Printing**

You can print the Manufacturing Operations and Manufacturing Tool Detail sheets, NC programs, and drawing for a part. The files are all ASCII text files that print like a text document.

1. Select **File > Print** from the menu.

- In the **Print** dialog, use the **Print Range** frame to choose what you want to print.

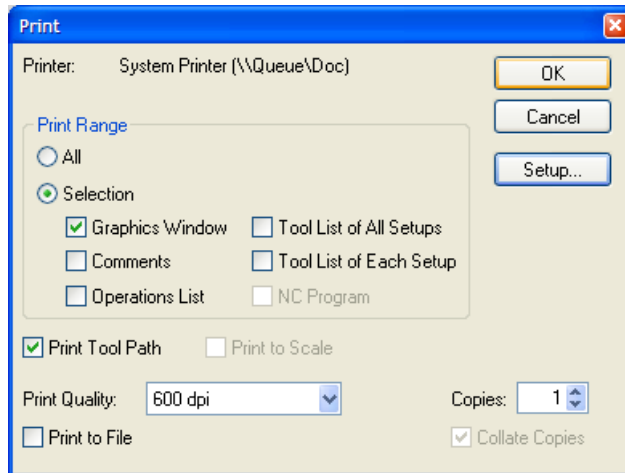

*Some options may not be available. For example, if you haven't yet generated the NC code, you can't print it.*

- If you are printing a drawing:
  - To print the toolpaths displayed in the **Graphics** window, select the **Print Toolpath** option.
  - To print the drawing at actual size, select the **Print to Scale** option. This means, that a 1 inch line segment, for example, will measure 1 inch on the paper.
  - To make the drawing fit the paper, leave the **Print to Scale** option deselected.
- Choose the **Print Quality** from the list. The specific options depend on your printer.
- Set the number of copies to print.
- Click **OK**.

## Keyboard shortcuts

Key sequence	Action
<b>Delete</b>	Delete the selected object
<b>Esc</b>	Stop current simulation
<b>F1</b>	Context-sensitive help
<b>Alt + F1</b>	Centerline simulation

<b>Key sequence</b>	<b>Action</b>
<b>Alt + F2</b>	Play or pause simulation
<b>Alt + F3</b>	Single-step simulation
<b>Alt + 1 (2,3,4)</b>	User View 1-4
<b>Alt + Enter</b>	Properties
<b>Alt + L</b>	Last view
<b>Alt + R</b>	Refresh
<b>Alt + Shift + V</b>	Save view
<b>Ctrl + A</b>	Select all
<b>Ctrl + C</b>	Copy
<b>Ctrl + E</b>	Center selected
<b>Ctrl + F</b>	Find (text in a text window). The cursor must be in a text window.
<b>Ctrl + H</b>	Replace (text in a text window). The cursor must be in a text window.
<b>Ctrl + L</b>	Center all
<b>Ctrl + N</b>	New file
<b>Ctrl + O</b>	Open file
<b>Ctrl + R</b>	New feature
<b>Ctrl + S</b>	Save file
<b>Ctrl + P</b>	Print
<b>Ctrl + V</b>	Paste
<b>Ctrl + Z</b>	Undo
<b>Ctrl + Y</b>	Redo
<b>Ctrl + X</b>	Cut
<b>Ctrl + Shift + A</b>	Shade selected
<b>Ctrl + Shift + C</b>	Unshade all

Key sequence	Action
<b>Ctrl + Shift + N</b>	Unshade selected
<b>Ctrl + Shift + P</b>	Toggles perspective

---

## Getting help

FeatureCAM provides a variety of ways for you to get help as you work. Context-sensitive help gives you quick access to the information relevant to the tasks you are attempting to carry out. You can also refer to the numerous examples in the **Examples** folder, located in the FeatureCAM root directory. Finally, if you cannot find an answer to your question, you can visit our website or contact our technical support.

### User manuals

User manuals are provided in Adobe's Portable Document Format (PDF), and can be accessed from the **Help** menu.

### Online help

The online help documentation is your primary source for in-depth technical information about FeatureCAM. It covers all FeatureCAM modules, and can be accessed from the **Help** menu, or by clicking  on the toolbar.

Three different tabs are available:

- **Contents** tab provides an outline view of the help system. Double-click a book or a page to open it.
- **Index** tab allows you to access the help file using index topics. Type the topic name in the top box and click the **Display** button.
- **Search** tab provides search capabilities for all pages of the help file. Type the word you would like to find in the top box and then pick a topic in the bottom box. Click **Display** to view the page.

### Context-sensitive help

You can use one of the following methods to get help relevant to the task you are carrying out:

- For some commands, FeatureCAM automatically displays the step-by-step instructions in the **Assistance** bar.

**Step 1: Pick point**

- When you hover the mouse over a toolbar icon for a few moments, a description of the icon is displayed.

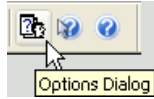

- Pressing **F1** displays the relevant help page.
- Most FeatureCAM dialogs have the **Help** button. Clicking it displays the relevant help page.
- Click the **Context Help**  button on the toolbar. When the cursor has changed to a question mark (?), click a menu item, button or dialog for more information.

## Links

You can find FeatureCAM information online via the **Help** menu:

Select:

- **Help > FeatureCAM Training** to book a training session.
- **Help > FeatureCAM on the Web** for product news, online support, discussion forum, and mailing list.
- **Help > Check for New Version** for product updates.

## Technical Support

If you have any questions related to FeatureCAM, which you cannot find an answer to in the documentation, you can contact the Delcam technical support service. Email [support@featurecam.com](mailto:support@featurecam.com), describing your problem as precisely as possible. This support is free for the first 60 days after your initial purchase and 30 days after the purchase of an upgrade.

# Introduction to 2.5D milling



*You must have MILL2.5D to perform this tutorial.*

This tutorial uses a simple example to introduce you to:

- Creating features
- 3D viewing
- Generating toolpaths
- 3D toolpath simulation
- Automatic tool selection, feed/speed calculation
- Dynamically generated setup documentation

The measurements in this tutorial are in inches; the values in millimeters are shown in brackets.

---

## Creating a part file

1. Start FeatureCAM by double-clicking the FeatureCAM icon  on the desktop.
2. If the **New Part Document** wizard is displayed, select the **New file** option, and click **Next**. Select **Milling Setup**, click **Inch** or **Millimeter**, depending on your preference, and click **Finish**.

If the **New Part Document** wizard is not displayed, select **File > New** from the menu. Select **Milling Setup**, click **Inch** or **Millimeter**, depending on your preference, and click **OK**.

3. In the **Stock** wizard (**Dimensions** page), enter **1** (25 mm) for **Thickness**, **4** (100 mm) for **Width**, **5** (120 mm) for **Length**, and click **Finish**.

Next time you use MILL, it will remember the stock dimensions that you entered last.



*In this tutorial, we assume that the stock has already been prepared.*

4. Click **OK** to close the **Properties** dialog.

For reference, here is a dimensioned drawing of the sample part:

English Units

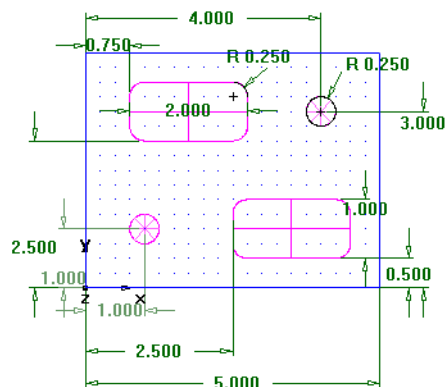

Metric Units

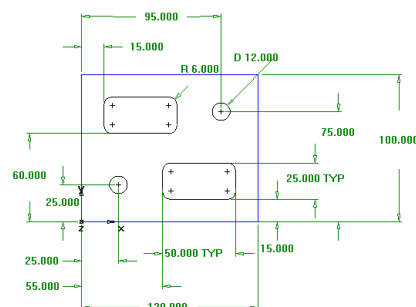

5. Create a hole feature.

- a. Select the **Features**  step from the **Steps** panel.
- b. In the **New Feature** wizard, select **Hole** in the **From Dimensions** frame, and click **Next**.
- c. Enter **0.5** (12 mm) for the **Diameter**, and click **Next**.





- d. Enter **1.0** (25 mm) for the **X** location of the hole center and **1.0** (25 mm) for the **Y** location.
- e. Click **Next**.

The **Strategies** page opens. This page provides control over the types of operations that will be used to cut the feature. The default operations for a hole are to spot drill and drill the hole. If the hole has a chamfer, the default is to cut the chamfer with the spot drill operation.

- f. Accept the default strategy settings by clicking **Next**.

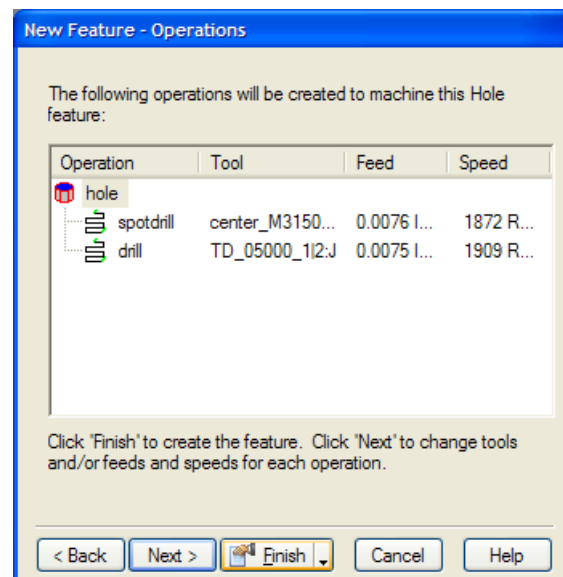
The **Operations** page shows a summary of the operations that will be created to cut the feature. The names of the tools that have been automatically selected and the feeds and speeds are also displayed.



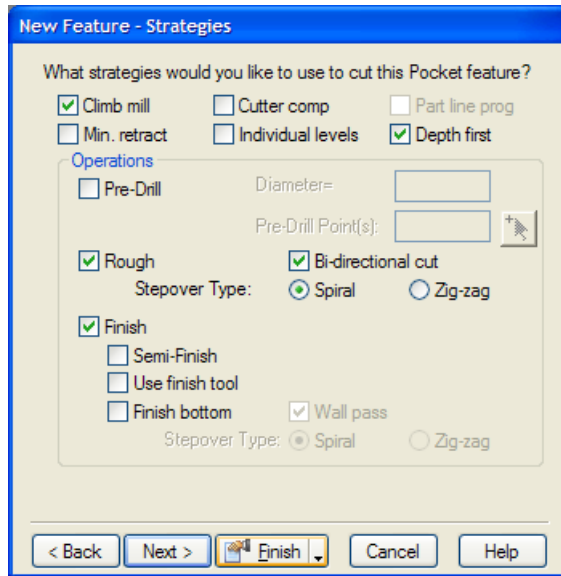

- g. Click the triangle next to the **Finish** button, and select the **Finish** option.
6. Create a pocket feature.
    - a. Select the **Features**  step from the **Steps** panel.
    - b. In the **New Feature** wizard, select **Rectangular Pocket** in the **From Dimensions** frame, and click **Next**.
    - c. Accept the default dimensions by clicking **Next**.
    - d. Enter **0.75** (15 mm) for **X**, **2.5** (60 mm) for **Y** and **0** for **Z**. Click **Next**.

The **Strategies** page indicates that rough and finish operations will be created.



e. Click the **Finish** button.

7. Use the **Features**  step to create a second **0.5** (12 mm) diameter hole at **X=4** (95 mm) and **Y=3** (75 mm).

8. Use the **Features**  step to create another pocket just like the first, except positioned at **X=2.5** (55 mm), **Y=0.5** (15 mm).

Your part in the **Graphics** window should look something like this:

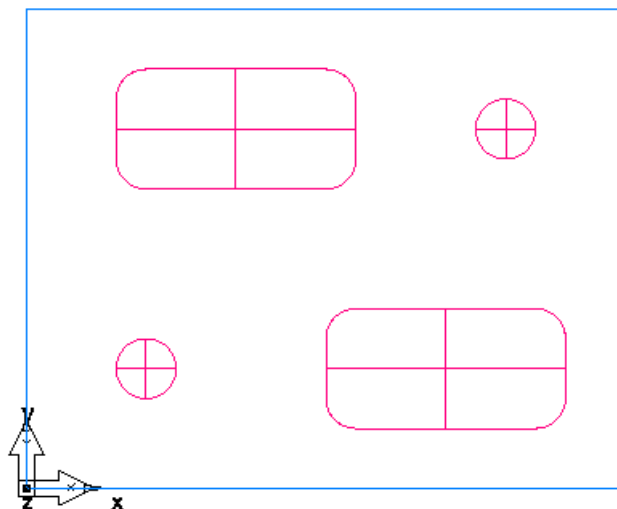

9. Select **Save** from the **File** menu, and save the part as **milling.fm**.

# Viewing

1. So far you have been viewing the part from the top view. Click the **Isometric View**  button on the **Standard** toolbar to get a 3-dimensional view.

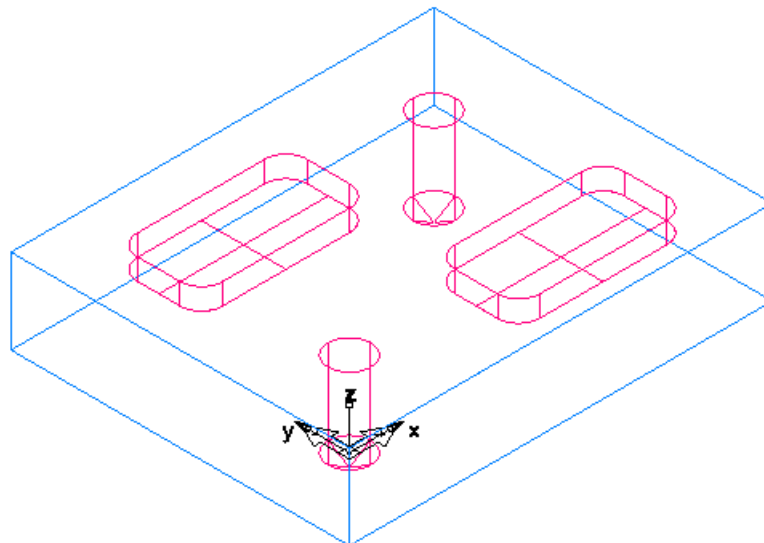

2. The **Isometric View**  button is part of the **Principle View** menu. Click the triangle next to the button to access the menu, and select **Front** to display the front view of the part.

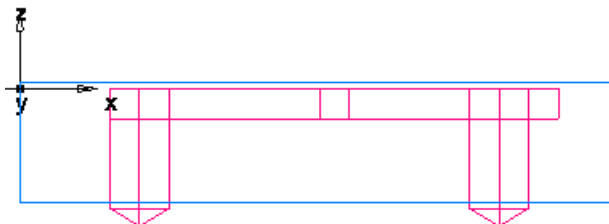

3. Click **Isometric** to return to the isometric view.





*See Interface tour (see page 15) for more information about pull-down menus.*

The sample part is complete. Now we will use the simulation features to see how the part will be manufactured.

---

# Toolpaths

1. Select the **Toolpaths**  step from the **Steps** panel. The **Simulation** toolbar is displayed.
2. Click the **3D**  button, and then click the **Play**  button to start the simulation. If the **Automatic Ordering Options** dialog appears, click **OK** to close it. The ordering options will be covered later.

A solid 3D rendering of the cutting process is displayed.

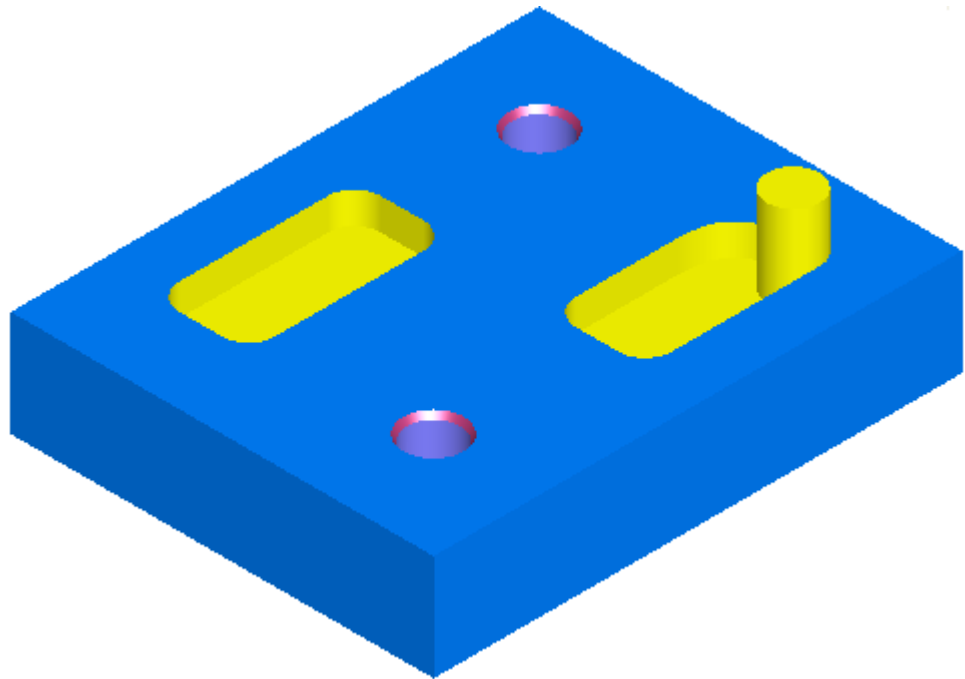

*MILL runs simulations best in 256 color mode or higher. Depending on your video settings, you might see a warning about this. You may ignore this warning for this tutorial.*

3. Click the **Play to Next Operation**  button. The spot drill operation is displayed.

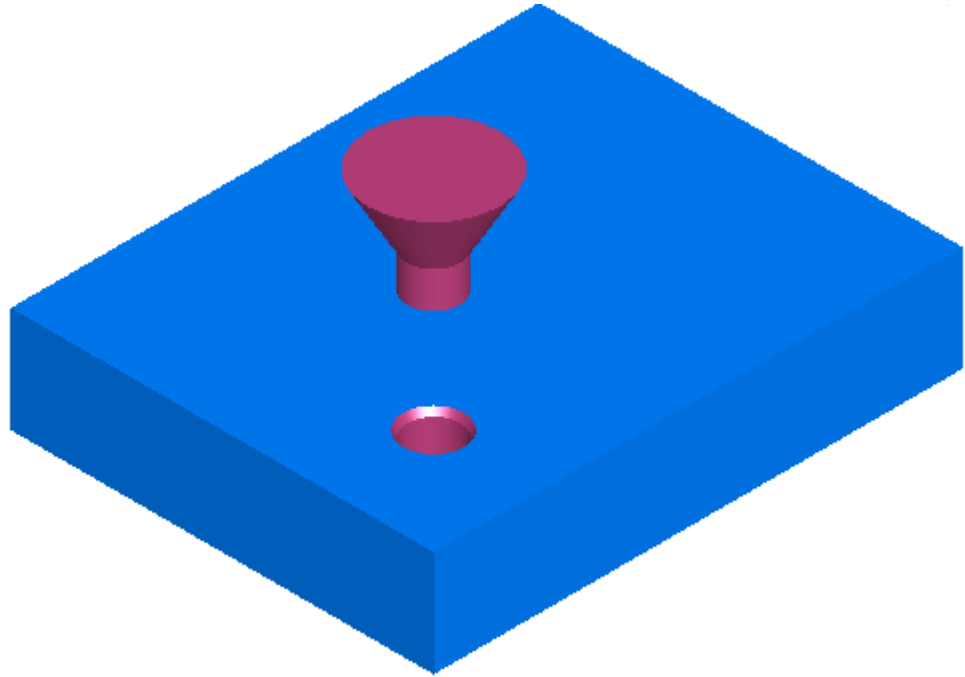

4. Click this button to view each operation until the entire part is cut.
5. Click **Eject** . The **Simulation** toolbar is removed from the screen.

---

## Order of manufacturing operations

The **Op List** tab in the **Results** window shows all of the operations that the features are translated into. A yellow warning  sign next to an operation indicates a potential problem with that operation. If you see any warnings, ignore them.

### To use the automatic ordering options:

1. Ensure that the **Automatic Ordering** option is selected on the **Op List** tab.  
This means that automatic rules are being applied to order the operations.
2. Change automatic ordering to group together the operations which use the same tool.
  - a. Click the **Ordering Options**  button.

- b. In the **Automatic Ordering Options** dialog, ensure that only the **Minimize tool changes** option is selected, and click **OK**.

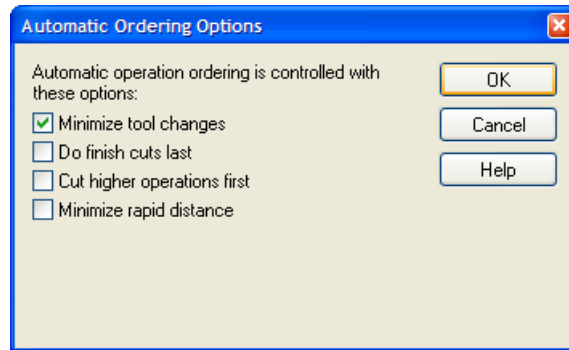

3. Simulate the part.

- a. Select the **Toolpaths**  step from the **Steps** panel.

The **Simulation** toolbar is displayed.

- b. Click the **3D Simulation**  button, and then click the **Play**  button.

If the **Automatic Ordering Options** dialog appears, click **OK** to close it. Notice that the simulation first performs all the spot-drills, then the drills, and then the rough and finish milling for the pockets.

- c. Click the **Stop**  button when simulation is complete to exit simulation mode.

4. Change automatic ordering to move the finish operations to the end of the list.

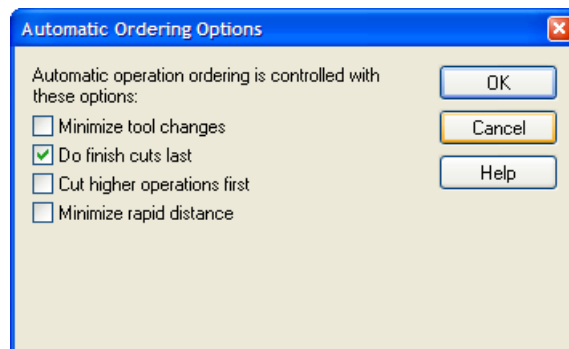

- a. Click the **Ordering Options**  button.

- b. In the **Automatic Ordering Options** dialog, select **Do Finish Cuts Last**, deselect everything else, and click **OK**.





The order of operations has changed in the **Operation List**.

5. Simulate the part.

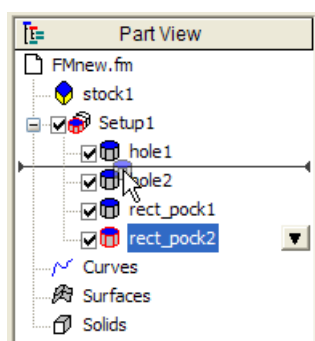
- a. In the **Simulation** toolbar, click the **Play**  button.  
The finish cuts for the two pockets are now cut last.
  - b. Click the **Stop**  button when simulation is complete.
6. Change automatic ordering to match the order of the features in the **Part View** panel.
- a. Click the **Ordering Options**  button.
  - b. Deselect everything, and click **OK**.
  - c. Open the **Part View** panel.  
The tree view contains all the setups and features you have created. See Part View panel (see page 45) for more details.
  - d. Click the **rect\_pock2** item in the **Setup1** node, and drag it up above **hole2**.



7. Simulate the part.
- a. In the **Simulation** toolbar, click the **Play**  button.  
The second pocket is now cut as the third feature.
  - b. Click the **Stop**  button when simulation is complete.

So far the order of the operations was determined automatically by a set of rules. You can also specify an exact ordering of operations manually.

### To use the manual ordering options:

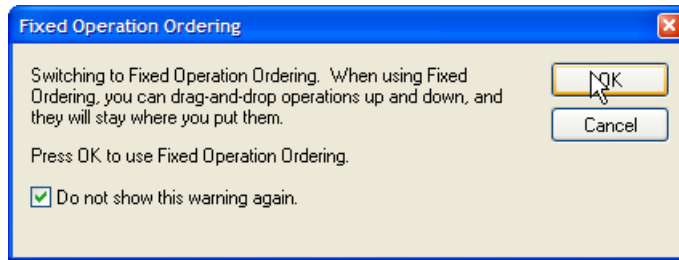

1. Select the **Manual Ordering** option on the **Op. list** tab.

2. In the **Fixed Operation Ordering** dialog, select **Do Not Show This Warning Again**, and click **OK**.

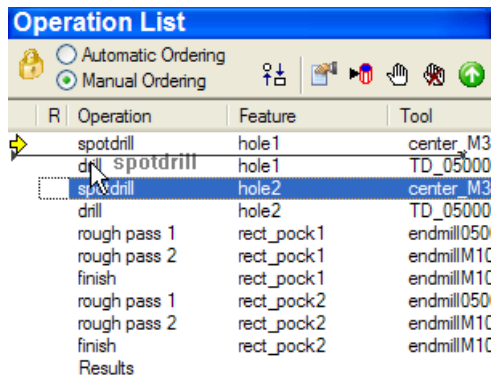

3. Select the **spotdrill** operation for **hole2** from the list, and drag it up ahead of the **drill** operation for **hole1**.



4. Simulate the part.
  - a. In the **Simulation** toolbar, click the **Play**  button.  
The simulation now performs the operations in the order that you had specified.
  - b. Click the **Stop**  button when simulation is complete.
5. Return to automatic ordering by selecting the **Automatic Ordering** option.
6. Click **OK** to close the **Automatic Ordering Options** dialog.



*If you want to erase the simulation and remove the **Simulation** toolbar, click the **Eject**  button.*

## Part documentation

Not only did the simulation model the manufacturing of the part, it also generated complete tool and operations lists. The tools selected are based on the tool cribs you design so you're always sure to simulate what you can produce with the tools at hand. The information is already computerized and can be printed for use as an operator's checklist.



1. Click the **Details** tab in the **Results** window.

By default, the Manufacturing Operations sheet is shown.

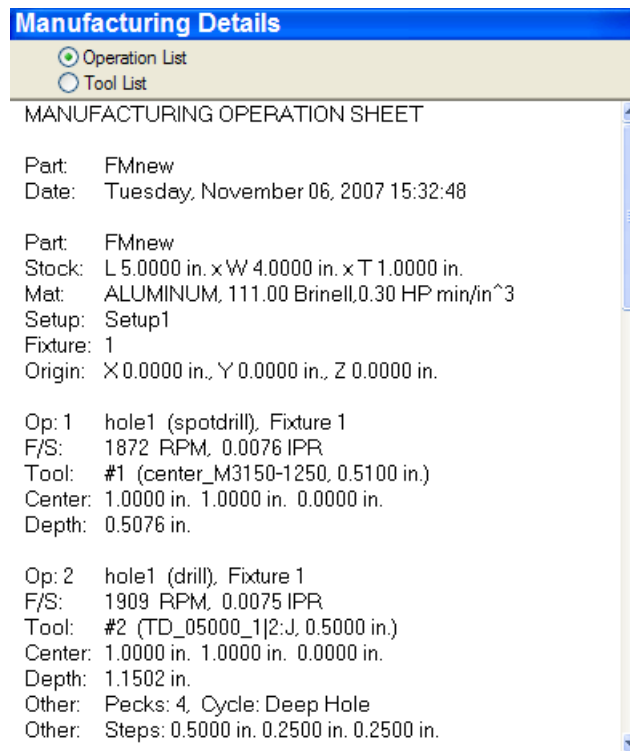

You can review this sheet using the scroll bars, or print it by selecting **Print** from the **File** menu.

2. Select the **Tool List** option at the top of the **Details** tab to show the Manufacturing Tool Detail sheet.

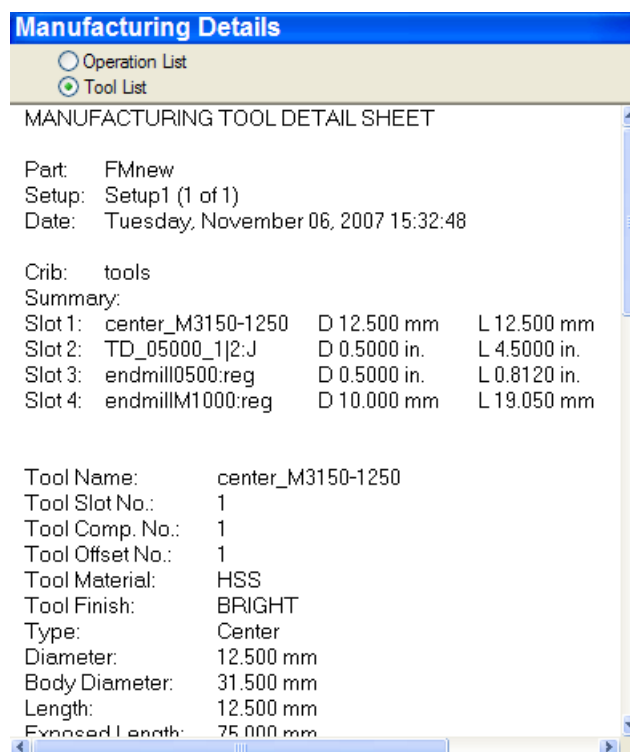

It contains all of the tools used to create the part based on the crib you have selected.



You can print this documentation by selecting **Print** from the **File** menu.

## Controlling the automation

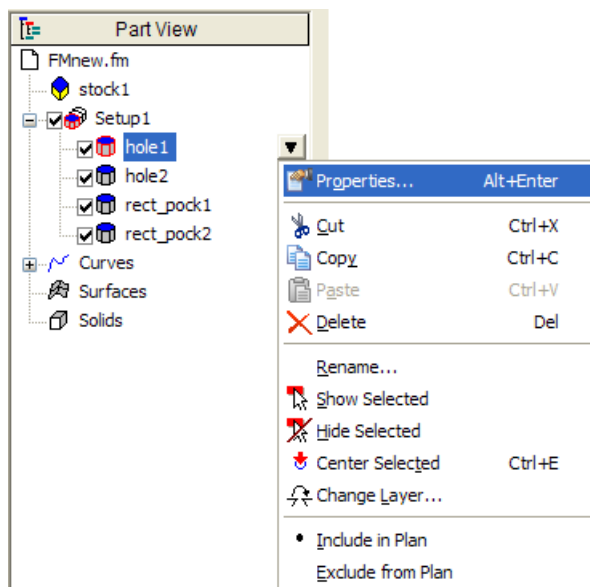

1. Open the **Part View** panel, right-click **hole1** under the **Setup1** node, and select the **Properties** option.

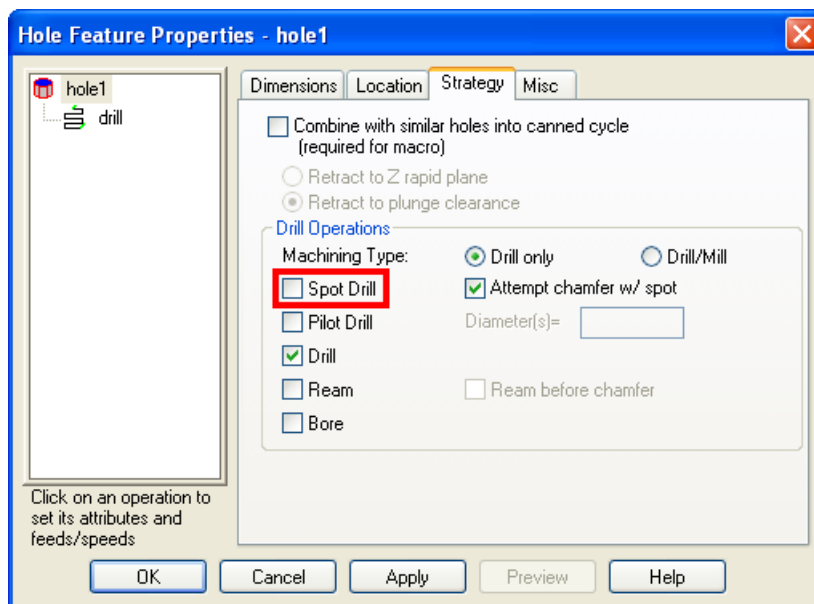

2. In the **Properties** dialog, click the **Strategy** tab, deselect the **Spot Drill** option, and click **OK**.



3. Select the **Toolpaths**  step from the **Steps** panel.

4. In the **Simulation** toolbar, click the **3D**  button, and then click the **Play**  button to start the simulation.



*There is no spot drilling for that hole this time. If you look through the operations list, notice there is now only one spotdrill operation listed. MILL can optimize the part manufacturing process for you, but you control the level of automatic optimization you want.*

5. Click **Eject** . The **Simulation** toolbar is removed from the screen.

---

## NC code

The purpose of MILL is to generate NC code to manufacture parts with CNC machines. After you have simulated the part, you can generate NC code. Before you can generate NC code for a part, you have to run a simulation to calculate toolpaths. If you are starting this part of the tutorial without having just run the simulation described above, simulate your part now (see page 61).

### To generate NC code:

1. Select the **NC Code**  step from the **Steps** panel.
2. Click the **View the NC Code**  button in the **NC Code** dialog to generate the NC code.



*If you are running an evaluation copy of MILL, a dongle, a device that attaches to the computer printer port, is necessary to generate NC code, or save or export files and is not available in the demonstration version. When you purchase MILL, a dongle is provided to you.*

---

## Tool mapping

1. Select the **NC Code**  step from the **Steps** panel.
2. Click the **Remap the Tools**  button in the **NC Code** dialog.

- The **Tool Mapping** dialog is displayed showing the current tool order. You can use it to modify the location of the tools in the tool changer. For example, let's move the center drill to the 5th position in the tool changer.

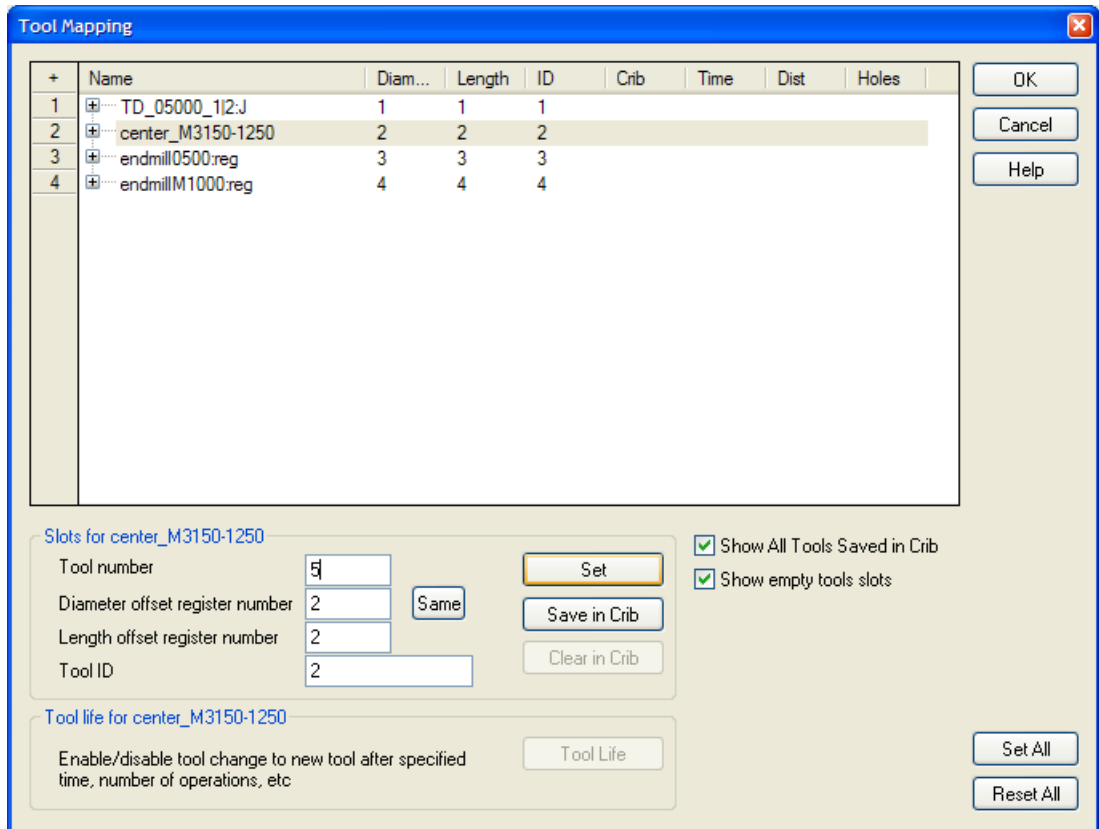

- Click **Center\_5** in the table.
- Change the **Tool Number** to **5** in the **Slots** frame.
- Click **Set**.



*You can't change the number directly in the table.*

- To save the changes, and close the **Tool Mapping** dialog, click **OK**.

## Changing post processors

- Select **Manufacturing > Post Process** from the menu.
- In the **Post Options** dialog, click the **Browse** button to view available post processors.

The default folder for milling posts is **C:\Program Files\FeatureCAM\M-LBRY\DUALUNITS**.

- Select your processor and click **Open**.



The new processor is shown in the **CNC File** field.

4. Click **OK** to exit the **Post Options** dialog and use the new post processor; click **Close** to exit the dialog and keep the original post processor.

5. Select the **Toolpaths**  step from the **Steps** panel.
6. Run a simulation of the part to regenerate the NC code.

---

## Saving NC code

1. Select the **NC Code**  step from the **Steps** panel.
2. Click the **Save NC**  button in the **NC Code** dialog.
3. In the **Save NC** dialog, accept the default filename and folder, and click **OK**. You are now ready to machine the part.

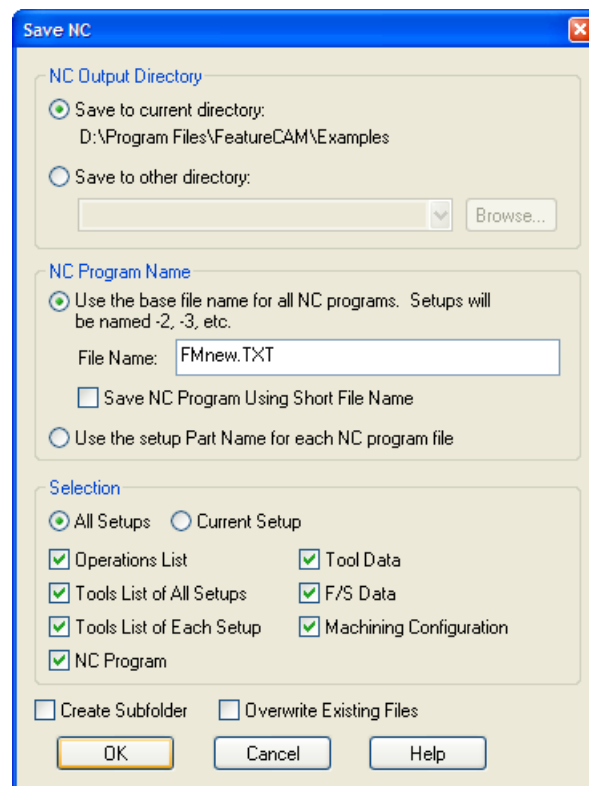

You have completed this tutorial.

# Features from curves



*You must have MILL to perform this tutorial. We recommend that you complete the Introduction to 2.5D milling (see page 56) tutorial before starting this one.*

This tutorial builds on the one you just completed and introduces you to:

- Creating geometry (lines, arcs, fillets, and so on)
- Creating irregularly-shaped features
- Contouring around a part and adjusting where the tool plunges

---

# Getting started

In the next sections we will build a curve around the features. The curve is created with the layout tools and drawing tools.

1. Select **File > Open** from the menu.
2. In the **Open** dialog, browse to the part file you created in the Introduction to 2.5D milling (see page 56) tutorial.

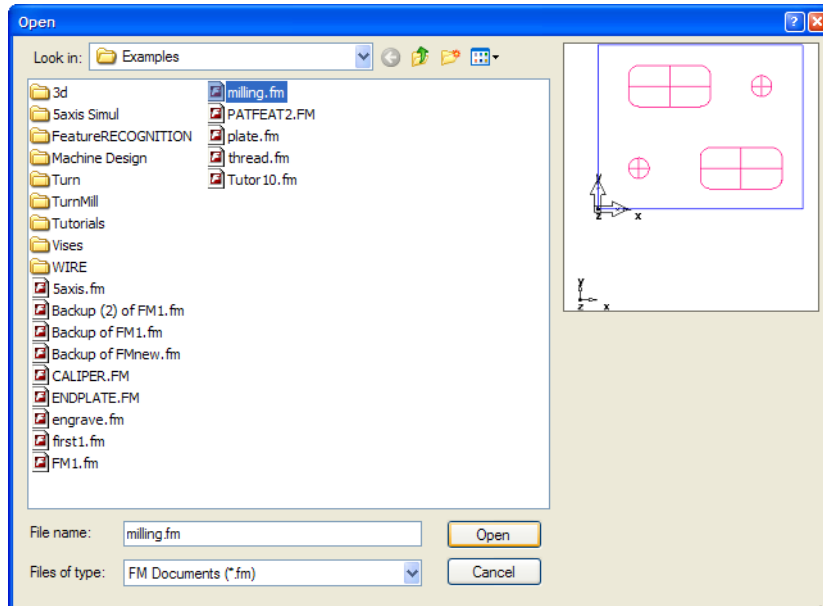

If you skipped the earlier tutorial, browse to the **sample2.fm** file (in inches), or the **mtrc\_gsg.fm** file (in metric units). If you installed FeatureCAM in the default folder, these files are in **C:\Program Files\FeatureCAM\Examples\Tutorials\Features from Curves**.

3. Click **Open**.

---

## Setting the snaps

1. Select **Options > Snapping Modes** from the menu.
2. In the **Snap Modes** dialog, click the following buttons: **Grid points**, **End points**, **Intersections**, **Circle centers**, **Tangent to objects**, **Display snap mode dialog**.

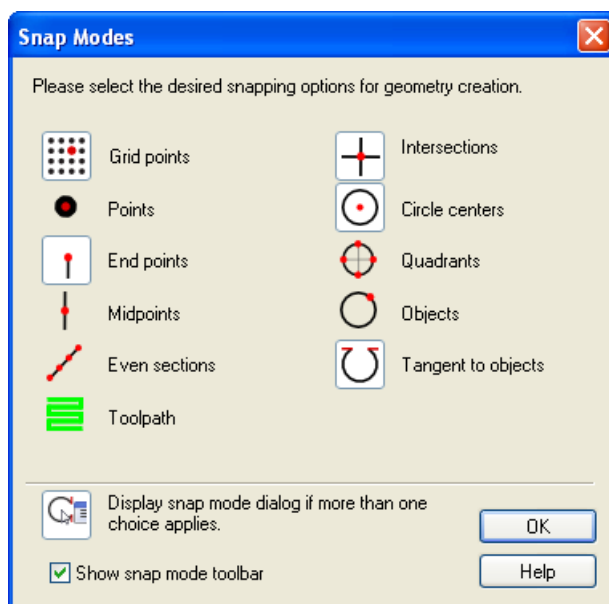

*Selected buttons have pale grey borders around them.*

3. Ensure the rest of the geometry creation buttons are not selected.



*If you want to have the **Snap Mode** toolbar displayed on the screen, select the **Show Snap Mode toolbar** option.*

4. Click **OK** to close the dialog.

---

## Building circles



1. Click the triangle next to the button in the **Principal View**  menu in the **Standard** toolbar, and select the **Top** option.



*It is usually easier to draw geometry in this view. For more information about the toolbar options, refer to the *Interface tour* (see page 15).*

2. Select the **Geometry**  step from the **Steps** panel.



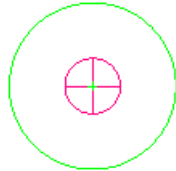

3. In the **Geometry Constructors** dialog, select the **Create more than one** check box at the bottom of the dialog, and click the **Circle from Rad, Center**  button.
4. In the **Feature/Geometry Edit** bar, enter **R = 0.75** inch (20 mm).
5. In the **Graphics** window, click near the center of one hole. The snap jumps to the grid at the hole's center. If you miss the hole center, click **Undo**  on the **Standard** toolbar and try again.

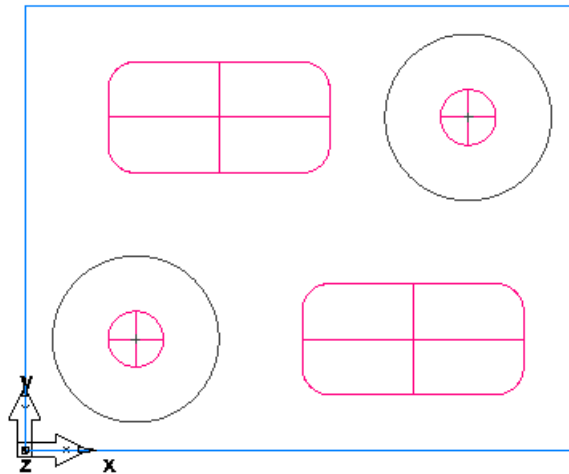

Repeat this action for the other hole. Your part now looks similar to the figure below:





## Drawing lines

1. Select the **Geometry**  step from the **Steps** panel.
2. In the **Geometry Constructors** dialog, ensure the **Create more than one** check box is selected, and click the **Line from 2 Pts**  button.

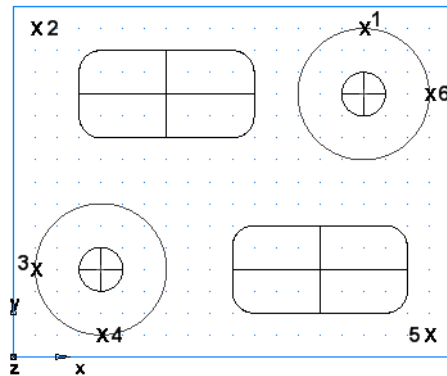
3. Use the diagram below to draw lines in the **Graphics** window:



- a. To create the first point **x1**, click the top of the right circle.  
If more than one snap possibility exists for the point you are creating, the **Snap Discrimination** dialog opens. Select the **Tangent to circle** option, and click **OK**.
  - b. For the second point **x2** click the upper left grid point.
  - c. Continue building lines from point **x2** to point **x3**, from point **x4** to point **x5**, and from point **x5** to point **x6**.
4. Create corner fillets.

- a. Select the **Geometry**  step from the **Steps** panel.
- b. In the **Geometry Constructors** dialog, ensure the **Create more than one** check box is selected, and click the **Corner Fillet**  button.
- c. In the **Feature/Geometry Edit** bar, enter **R = 0.75** inch (20 mm).
- d. Position the mouse in the upper left corner, and click. A corner fillet appears automatically trimming the lines to fit.

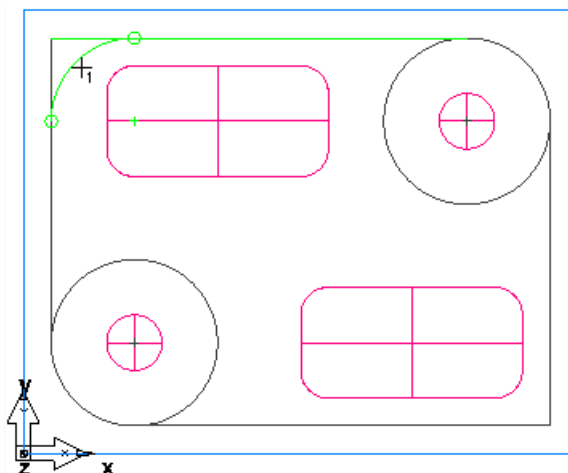

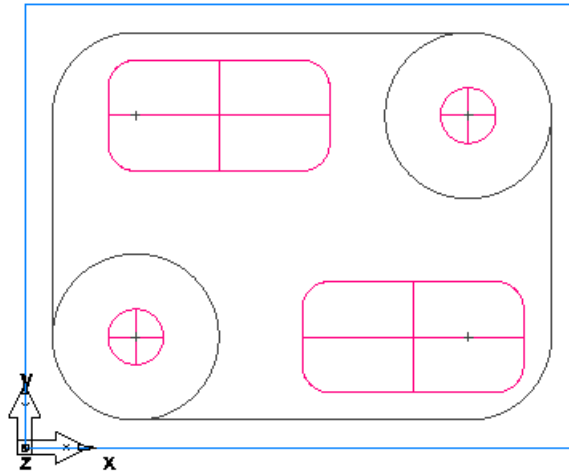

- e. Position the mouse in the lower right corner. A corner fillet appears automatically trimming the lines to fit.

The drawing should look something like this:



## Chaining a curve

1. Click the **Curves**  step from the **Steps** panel.
2. In the **Curves Creation** dialog, select the **Closed Curve**  button.
3. In the **Graphics** window, click the bottom line.

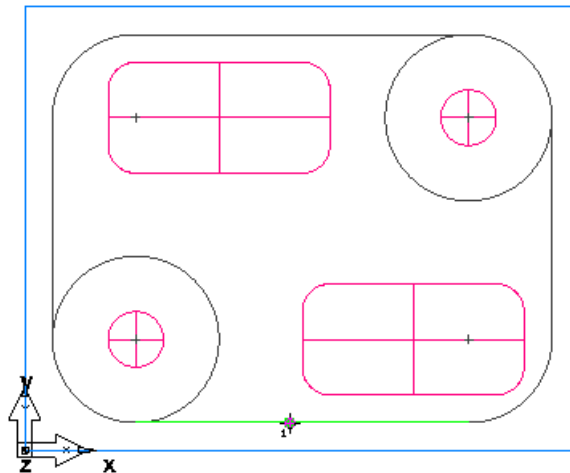

MILL automatically chains a closed curve, and chooses a smooth path so you don't have to chain all curves manually.

# Creating a feature from a curve

1. With the curve still highlighted in the **Graphics** window, select the **Features**  step from the **Steps** panel.

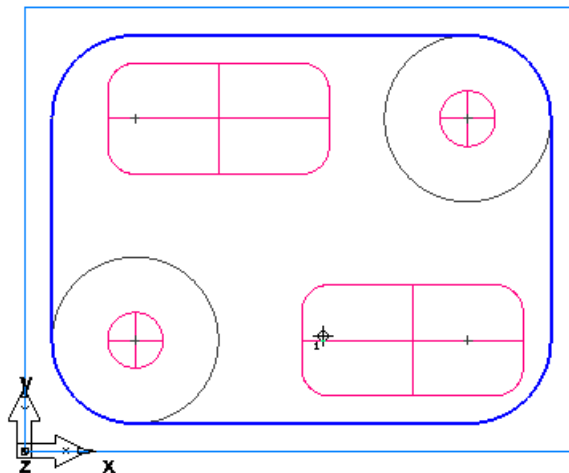

2. In the **New Feature** wizard, select **Boss** in the **From Curve** frame, and click **Next**.

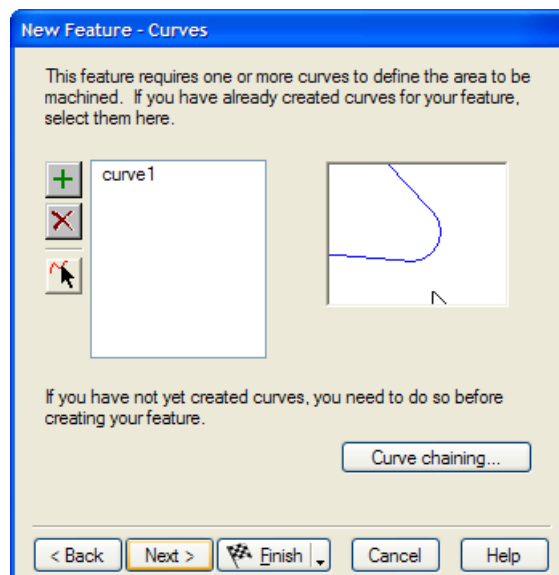





The curve you selected is already selected in the wizard.

3. Keep clicking **Next** until you get to the **Dimensions** page.
4. Set the **Height** to **0.75** (20 mm).
5. Click **Finish**.

---

## Simulating the part

You are now ready to simulate your part.

1. Click the **Isometric View**  button on the **Standard** toolbar to get a 3-dimensional view.
2. Select the **Toolpaths**  step from the **Steps** panel.
3. In the **Simulation** toolbar, click the **3D**  button, and then click the **Play**  button to start the simulation. If the **Automatic Ordering Options** dialog appears, click **OK** to close it.

The 3D simulation is displayed in the **Graphics** window.

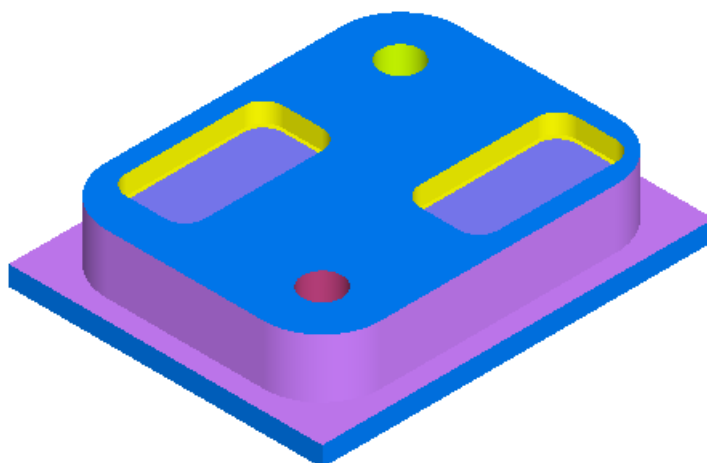

4. Click **Eject** . The **Simulation** toolbar is removed from the screen.

---

## Modifying the boss feature to contour around the part

If you watched the simulation carefully, you saw that the boss feature performed both a roughing and finishing operation. To simply contour around the outer boundary of the part, you need to eliminate the roughing operation. The operations that are initially created for a feature are specified on the **Strategies** page of the **New Feature** wizard, but you can easily modify the strategy for any existing feature.

### To modify the feature's strategy:

1. In the **Graphics** window, select the **boss1** feature.

2. Click the **Properties** button in the **Feature/Geometry Edit** bar. The **Properties** dialog opens. It contains the pages of the **New Feature** wizard as separate tabs.
3. Click the **Strategy** tab. Notice that the **Rough** and **Finish** check boxes are selected. Deselect the **Rough** option, and click **OK**.

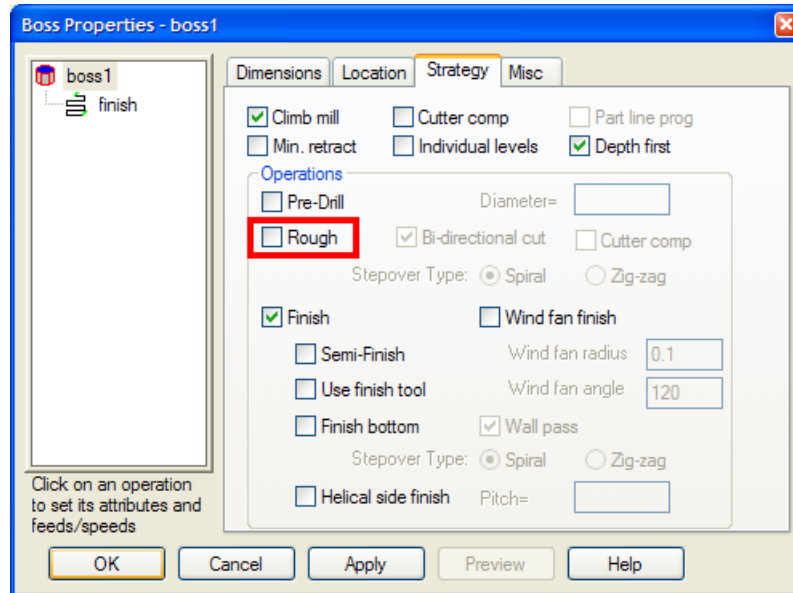

4. Select the **Toolpaths**  step, and simulate the part.

## Changing the plunge point

During the simulation, you saw that the tool ramped on and off the part at the location where you chained the curve. At the moment, the tool is plunging on the stock. Let's modify the plunge point for this operation.

### To change the plunge point:

1. Click the triangle next to the button in the **Principal View**  menu in the **Standard** toolbar, and select the **Top** option.
2. In the **Graphics** window, select the **boss1** feature, and click the **Properties** button in the **Feature/Geometry Edit** bar.

The **Properties** dialog opens. The left-hand side of the dialog contains the tree view. It shows the feature with its operations listed underneath. By clicking on an operation in the tree view, you can modify an operation.

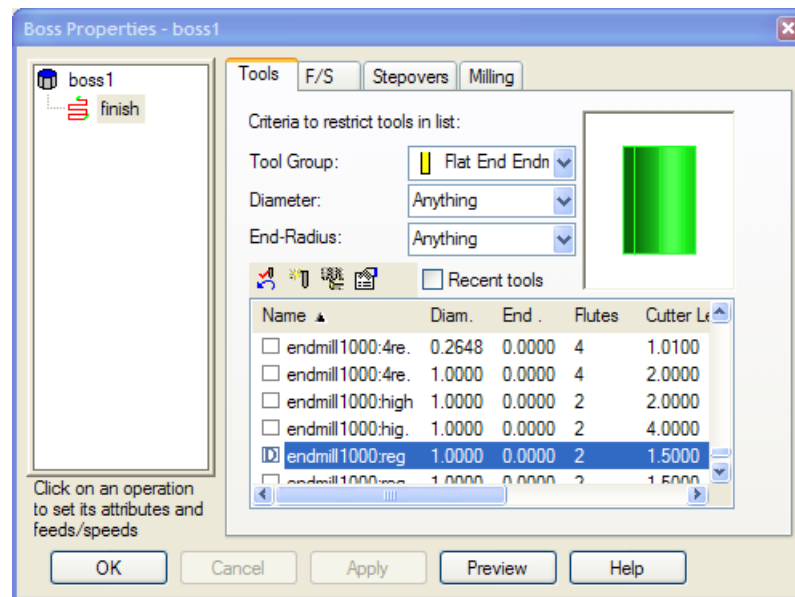



3. Click the **finish** operation in the tree view. The tabs of the dialog change to represent information specific to the operation.
4. Click the **Milling** tab. This tab contains the various attributes for changing the toolpaths that are generated for the operation.
5. Select the **Plunge points** attribute, and click the **Pick Location**  button.

The **Properties** dialog warps away, and the cursor point changes its shape.

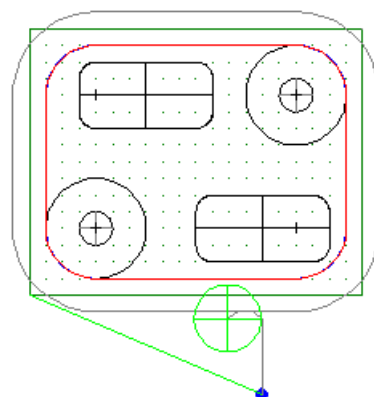
6. Click at a location below the part.



7. Click **OK** to close the dialog.
8. Simulate the part:

- a. Select the **Toolpaths**  step from the **Steps** panel.
- b. In the **Simulation** toolbar, click the **Show Centerline**  button, and then click the **Play**  button to view the changes in the toolpath.



*If you pick a location that is too close to the part, the plunge point is ignored, and the toolpaths will remain unchanged.*

You have completed this tutorial.



# Introduction to turning



*You must have TURN or TURN/MILL to perform this tutorial.*

The example in this tutorial is a simple turned part designed to introduce you to several of the drawing and machining tools available in TURN. The tutorial walks you through creating the part and introduces you to TURN's automation and ease of use.

The measurements in this tutorial are in inches; the values in millimeters are shown in brackets.

---

## Getting started

In the next sections we will be using TURN. If you don't have a license for this module, but would like to evaluate it:

1. Start FeatureCAM by double-clicking the FeatureCAM icon  on the desktop.
2. From the **File** menu, choose **Evaluation Options**, and make sure **Turning** is selected.
3. Click **OK**.

---

## Create a part file

1. If the **New Part Document** wizard is displayed, select the **New File** option, and click **Next**. Select **Turn/Mill**, select **Inch** or **Millimeter**, and click **Finish**.

If the **New Part Document** wizard is not displayed, select **File > New** from the menu. Select **Turn/Mill**, click **Inch** or **Millimeter**, depending on your preference, and click **OK**.

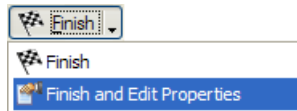

2. Create the stock.
  - a. In the **Stock** wizard (**Dimensions** page), set the **OD** to **4** (100 mm), **Length** to **5** (125 mm), and **ID** to **0**, and click **Next**.  
A turning setup defaults to a round stock.
  - b. Click the triangle next to the **Finish** button, and select the **Finish and Edit Properties** option.

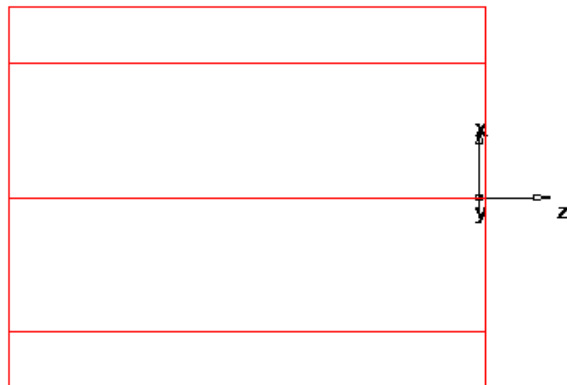

- c. In the **Properties** dialog, set **Z** to **0.0625** (1.5 mm), and click **OK**.
3. Select **Options > Turning Input Modes > 3D (XYZ)** from the menu.
4. Select **Manufacturing > Set Tool Crib** from the menu, choose the **Tools** option in the **Select Active Tool Crib** dialog, and click **OK**.
5. Click the triangle of the **View**  menu on the **Standard** toolbar, and choose the **Center All** option to bring your entire drawing into view.

Your part should look something like this:



6. Draw two lines:
  - a. Select the **Geometry**  step from the **Steps** panel.
  - b. In the **Geometry Constructors** dialog, ensure the **Create more than one** check box is selected, and click the **Line from 2 pts**  button.

c. In the **Feature/Geometry Edit** bar, enter the following values to create two lines that define the OD profile:

point 1: **X=2** (50 mm); **Y=0**, **Z= -3.5** (-88 mm)

point 2: **X=1** (25 mm), **Y=0**, **Z= -3.5** (-88 mm)

Press **Enter**. A line is drawn in the **Graphics** window.

d. Create a second line with the values:

point 1: **X=1** (25 mm), **Y=0**, **Z= -3.5** (-88 mm)

point 2: **X=1** (25 mm), **Y=0**, **Z=0**

Press **Enter**. Your part now looks something like this:

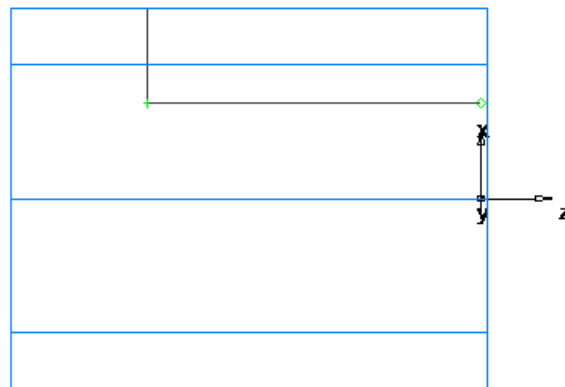

7. Create a chamfer to trim your lines.

a. Select the **Geometry**  step from the **Steps** panel.

b. In the **Geometry Constructors** dialog, click the **Chamfer**  button in the list of **Fillet** commands.

c. In the **Feature/Geometry Edit** bar, enter **width=0.25** (6 mm) and **height=0.25** (6 mm).

d. Position your mouse close to the chamfer location as shown in the figure below. The chamfer snaps into place.

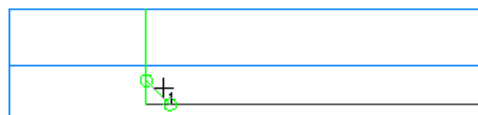

e. Click once to place the chamfer on your drawing. The chamfer automatically trims your lines.

8. Create third line. It will be used to create a bore feature later.

a. Select the **Geometry**  step from the **Steps** panel.

b. In the **Geometry Constructors** dialog, click the **Line from 2 pts**  button.

c. In the **Feature/Geometry Edit** bar, enter the following values:

point 1: **X=0.625** (16 mm), **Y=0**, **Z=0**

point 2: **X=0.625** (16 mm), **Y=0**, **Z= -3.75** (-94 mm)

d. Press **Enter**.

9. Chain the trimmed lines into curves.

a. Select the **Curves**  step from the **Steps** panel.

b. In the **Curves Creation** dialog, select the **Pick Curve Pieces**  button.

c. In the **Graphics** window, click locations **1, 2, 3** as shown in the figure below. Each line segment changes color when it is selected.

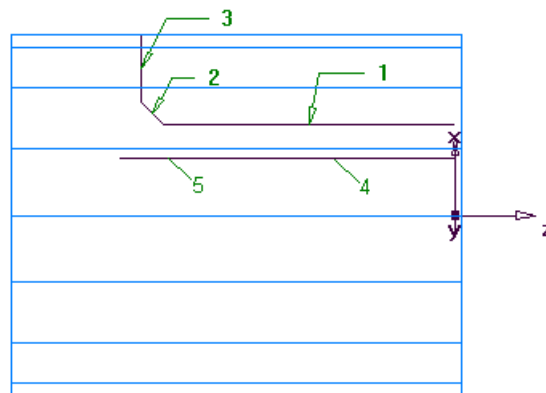

d. In the **Feature/Geometry Edit** bar, name the curve **turn**, and press **Enter**.

10. Chain the Bore ID curve.



a. Select the **Curves**  step from the **Steps** panel.

b. In the **Curves Creation** dialog, click the **Pick Curve Pieces**  button.

c. In the **Graphics** window, click locations **4** and **5**, as shown above.

d. In the **Feature/Geometry Edit** bar, name the curve **bore**, and press **Enter**.

# Making features

1. Use the **2D Turned Profiles**  button, on the **Display Mode** toolbar, to switch to a simplified 2D representation of your part.
2. Create a turn feature.
  - a. Select the **Features**  step from the **Steps** panel.
  - b. If you have the Turn/Mill module, the **New Feature** wizard asks you which type of feature you want to create. Select the **Turning** option, and click **Next**.

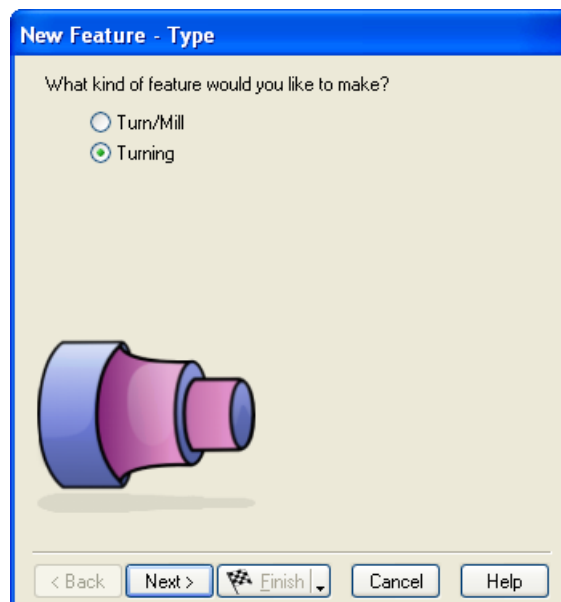

- c. Select **Turn** in the **From Curve** frame, and click **Next**.
- d. Select the curve graphically:

In the **Curve** field select **turn** from the list.

Click the **Pick Curve**  button. The dialog minimizes to reveal the **Graphics** window beneath.

Click the curve you named **turn** earlier.

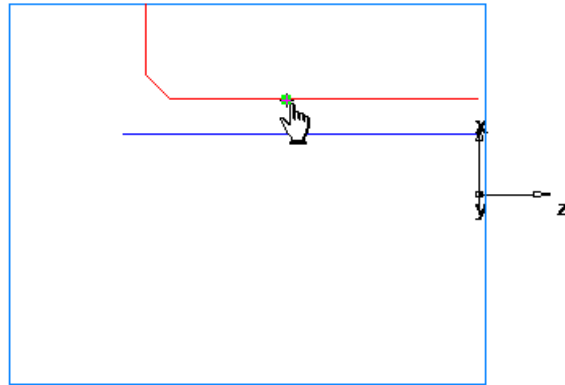

In this particular case, two objects are available for selection: a line and a curve. Whenever your selection needs to be clarified, FeatureCAM opens the **Select** dialog.

In the **Select** dialog, choose **turn**, and click **OK**.

- e. Click **Next**.

Your drawing should look something like this:

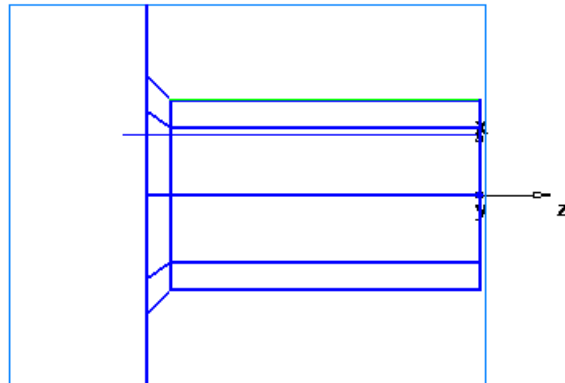

- f. Click the triangle next to the **Finish** button, and select the **Finish and Create More** option to continue creating features.

3. Create a face feature.

- a. If the **New Feature** wizard asks you which type of feature you want to create, select the **Turning** option, and click **Next**.
- b. Select **Face** in the **From Dimensions** frame, and click **Next**.
- c. Set **Outer Diameter** to 4 (100 mm), **Inner Diameter** to 0, **Thickness** to 0.0625 (1.5 mm).

A face feature automatically knows the **OD** and **ID** values from the stock properties.

- d. Click **Finish**.

4. Create a hole feature.

- a. If the **New Feature** wizard asks you which type of feature you want to create, select the **Turning** option, and click **Next**.
- b. Select **Hole** in the **From Dimensions** frame, and click **Next**.
- c. On the **Dimensions** page, set the **Diameter** to 1.0 (24 mm), **Depth** to 3.75 (94 mm).
- d. Click **Next**, and set **Z** to 0.

Your drawing should look something like this:

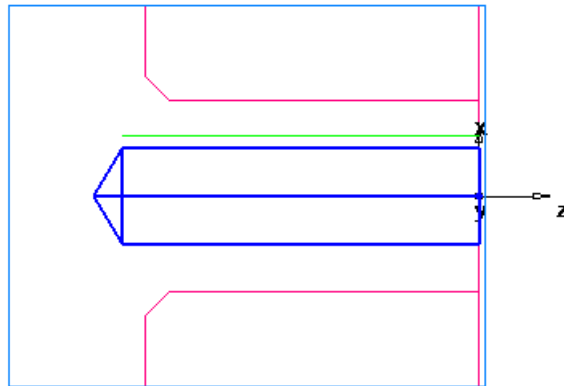

- e. Click **Finish**.
5. Create a bore feature by using the same process you used to create the turn feature. Use the curve you named **Bore**.

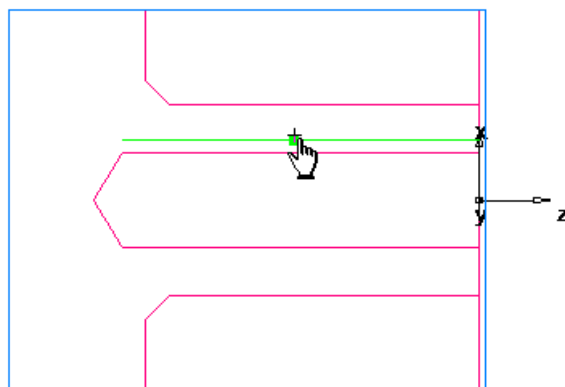

6. Create a groove feature.
- a. If the **New Feature** wizard asks you which type of feature you want to create, select the **Turning** option, and click **Next**.
  - b. Select **Groove** in the **From Dimensions** frame, and click **Next**.
  - c. On the **Dimensions** page, set **Location** to **ID**, **Orientation** to **X-axis**, **Diameter** to 1.25 (31 mm), **Depth** to 0.125 (3 mm), **Width** to 0.250 (6 mm). Leave the other settings at 0.
  - d. Click **Next**, and set **Z** to -3 (-75 mm).

Your drawing should look something like this:

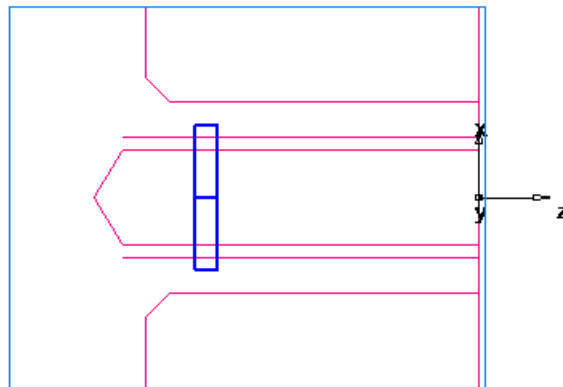

- e. Click **Finish**.
7. Create a thread feature.
    - a. If the **New Feature** wizard asks you which type of feature you want to create, select the **Turning** option, and click **Next**.
    - b. Select **Thread** in the **From Dimensions** frame, and click **Next**.
    - c. On the **Dimension** page, select **Get the thread dimensions from a standard thread**, click **OD**, and select the **2.0000-4.5 UNC (M50-15** for metric) in the **Designation** field.
    - d. Click **Next**.
    - e. On the **Dimensions** page, set **Thread** to **Right hand**, **Thread Length** to **1.0 (24 mm)**, and click **Next**.

Your drawing should look something like this:

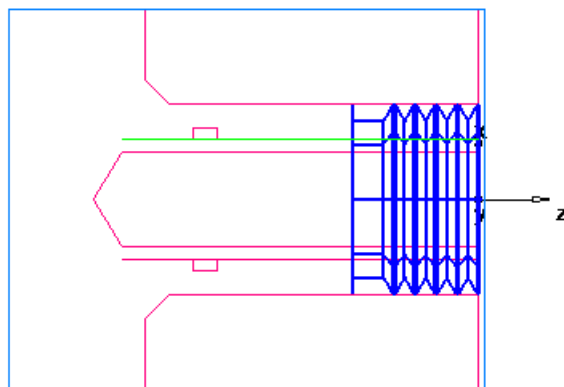

- f. Click **Finish**.
8. Create a cutoff feature.
    - a. If the **New Feature** wizard asks you which type of feature you want to create, select the **Turning** option, and click **Next**.
    - b. Select **Cutoff** in the **From Dimensions** frame, and click **Next**.



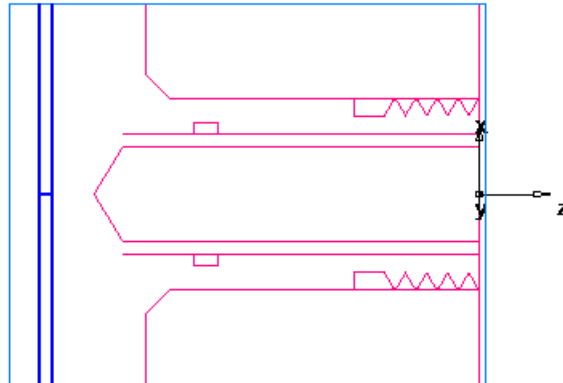

- c. On the **Dimensions** page, set **Diameter** to 4 (100 mm), **Inner Diameter** to 0, **Width** to 0.122 (3 mm).
- d. Click **Next** and set **Z** to -4.5 (-112 mm).

Your drawing looks something like this:



- e. Click **Finish**.

## Viewing

1. Click the **2D Turned Profiles**  button, on the **Display Mode** toolbar, to return to a 3-dimensional view of the model.
2. Click the **Isometric View**  button on the **Standard** toolbar.

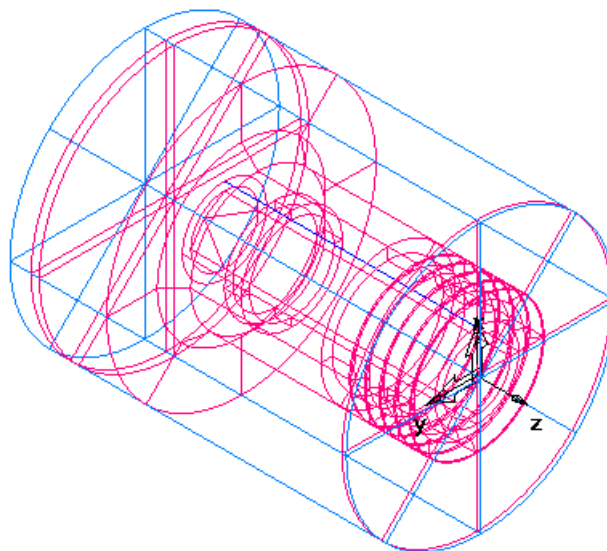

3. Shade the part.
  - a. Open the **Part View** panel, and select **bore1** under the **Setup1** node.
  - b. Click the **Shade Selected**  button on the **Display Mode** toolbar.

- c. Select **thread1**, and click the button again.

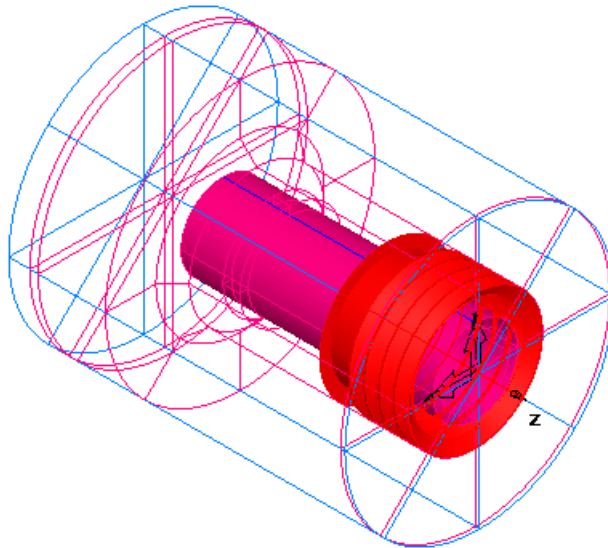



4. Click the **Unshade All**  button on the **Display Mode** toolbar to return to the line drawing view.

The sample part is complete. Now the simulation features will be used to see how the part will be manufactured.

---



## Toolpaths

1. Select the **Toolpaths**  step from the **Steps** panel. The **Simulation** toolbar is displayed.
2. Click the **3D**  button, and then click the **Play**  button to start the simulation. If the **Automatic Ordering Options** dialog appears, click **OK** to close it. The ordering options will be covered later.

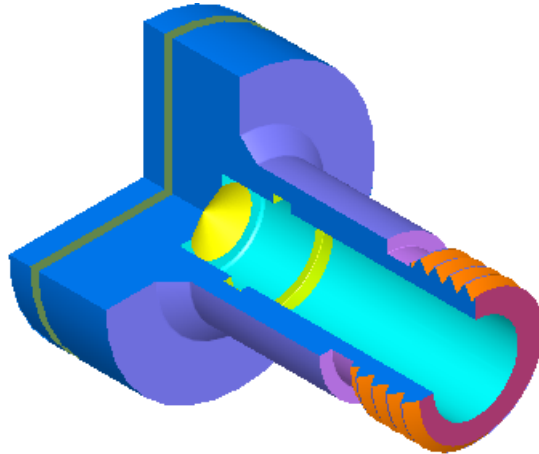
A solid 3D rendering of the cutting process is displayed. By default, the 3/4 view is shown when cutting or drilling the ID of the part. You can control this setting by selecting **Options > Simulation** from the menu.



*FeatureCAM runs simulations best in 256 color mode or higher. Depending on your video settings, you might see a warning about this. You may ignore this warning for this tutorial.*

3. Click the **Play to Next Operation**  button. The face operation is displayed.
4. Click this button to view each operation until the entire part is cut.
5. Click **Eject** . The **Simulation** toolbar is removed from the screen.

---

## Ordering of operations

The **Op List** tab in the **Results** window shows all of the operations that the features are translated into. A yellow warning  sign next to an operation indicates a potential problem with that operation. If you see any warnings, ignore them.

The ordering can be automatic or manual.

### Automatic ordering

You can control the automatic ordering of operations by using either rules or operation templates. Using rules is similar to the way you used automatic ordering in the 2.5D Milling tutorial (see page 62).

In this section we will change the automatic ordering by modifying the **Turn Operation** template. This template lists the manufacturing order of the various turning features.

### To modify the template:

1. Click the **Ordering options**  button on the **Op List** tab in the **Results** window.

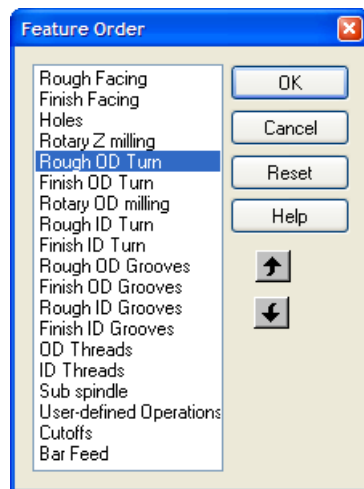

The **Automatic Ordering Options** dialog opens.

2. Select the **Use template** option, and click **Edit template**.
3. In the **Feature Order** dialog, click **Rough OD Turn**.



4. Click the down arrow until the item is located under the **Finish ID Turn** operation.
5. Click **Finish OD Turn**, and click the down arrow until the item is located under **Finish ID Turn**.
6. Click **OK** to close the **Feature Order** dialog.
7. Click **OK** to close the **Automatic Ordering Options** dialog.
8. Simulate the part.

- a. Select the **Toolpaths**  step from the **Steps** panel. The **Simulation** toolbar is displayed.

- b. Click the **3D**  button, and then click the **Play**  button.

Notice that the OD roughing and finishing now happen after the hole is drilled.

- c. Click the **Stop**  button when simulation is complete to exit simulation mode.

## Manual ordering

You can specify an exact ordering of operations manually, the same way as you did in the 2.5D Milling tutorial (see page 62).

---

# Part documentation

TURN automatically generates the part documentation, which you can view by clicking the **Details** tab in the **Results** window.

The Manufacturing Operation List is shown by default. It contains information such as machining time, selected tools, feeds and speeds, and horsepower requirements for the various operations. Each operation of the process plan is listed in order.

The Tool List is displayed by selecting the **Tool List** option at the top of the **Details** tab. It contains a summary of all the tools needed for the job as well as details of each tool.



*You can print this documentation by selecting **Print** from the **File** menu.*

---

# NC code

After you have simulated the part, you can generate NC code. TURN comes with many post processors and the ability to create custom post processors as well.

Before you can generate NC code for a part, you have to run a simulation to calculate toolpaths. If you are starting this part of the tutorial without having just run the simulation described above, simulate your part now (see page 91).

### To generate NC code:

1. Select the **NC Code**  step from the **Steps** panel.
2. Click the **View the NC code**  button in the **NC Code** dialog to generate the NC code.



*If you are running an evaluation copy of TURN, a dongle (a device that attaches to the computer printer port) is necessary to generate NC code, or save or export files and is not available in the demonstration version. When you purchase TURN, you will receive a dongle.*

---

## Changing post processors

If you are running TURN, the default post processor is for a Bridgeport machine. Follow the steps to change your post processor and generate the NC code.

1. From the **Manufacturing** menu, select the **Post Process** option.
2. In the **Post Options** dialog, click the **Browse** button to view available post processors.

The default folder is **C:\Program Files\FeatureCAM\T-lbry\Inch** for English units. If you need a metric post, browse up one folder level to **T-lbry**. Then browse the **Metric** folder.

3. Select your processor and click **Open**.

The new processor is shown in the **CNC File** field.

4. Click **OK** to exit the **Post Options** dialog and use the new post processor; click **Close** to exit the dialog, and keep the original post processor.

5. Select the **Toolpaths**  step, and run a simulation of the part to regenerate the NC code.

---

## Saving NC code

1. Select the **NC Code**  step from the **Steps** panel.
2. Click the **Save NC**  button in the **NC Code** dialog.

3. In the **Save NC** dialog, accept the default filename and folder, and click **OK**. You are now ready to machine the part.

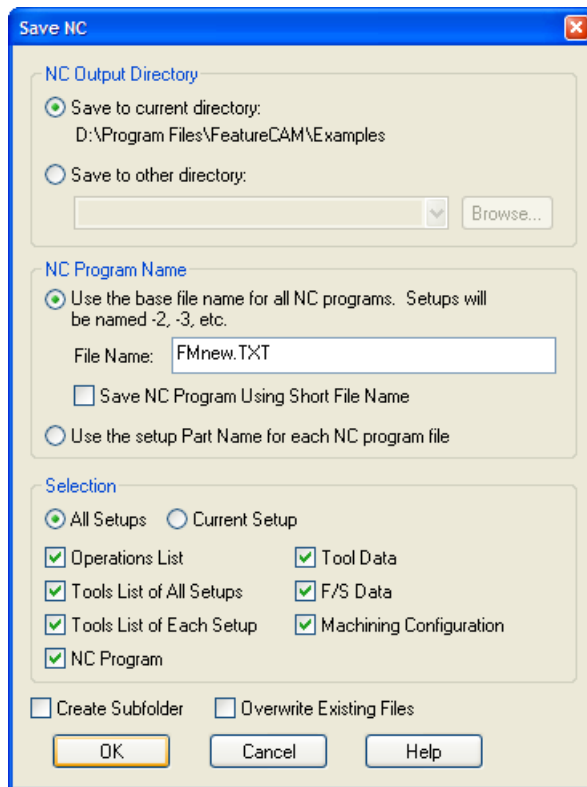

You have completed this tutorial.

# Introduction to turn/mill



*You must have licensed the **Turn/Mill** option to run this tutorial. This tutorial is only available in inch units.*

This tutorial introduces you to:

- Creating parts for lathes with milling capabilities.
- Mixing turning and milling features.
- Creating milling features on the OD and face of the part.
- Simulating a turn/mill part.

---

## Getting started

1. Start FeatureCAM by double-clicking the FeatureCAM icon  on the desktop.
2. If the **New Part Document** wizard is displayed, select the **New file** option, and click **Next**. Select **Turn/Mill**, click **Inch**, and click **Finish**.

If the **New Part Document** wizard is not displayed, select **File > New** from the menu. Select **Turn/Mill**, click **Inch**, and click **OK**.

3. In the **Stock** wizard (**Dimensions** page), enter **3** for the **OD**, **2** for the **Length**, and **0** for the **ID**.

If the wizard does not open automatically, select the **Stock**  step from the **Steps** panel.





*A turn/mill setup defaults to a round stock.*

4. Click the triangle next to the **Finish** button, and select the **Finish** option.
5. Click the triangle of the **View**  menu on the **Standard** toolbar, and choose the **Center All** option to bring your entire drawing into view.

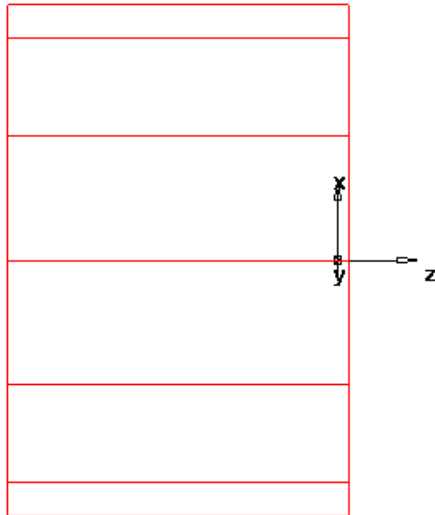

Your part should look something like this:



6. Select **Options > Turning Input Modes > Diameter** from the menu.

---

## Creating a turn feature

1. Draw three lines.
  - a. Select the **Geometry**  step from the **Steps** panel.
  - b. In the **Geometry Constructors** dialog, ensure the **Create More Than One** check box is selected, and click the **Connected Lines**  button.
  - c. In the **Feature/Geometry Edit** bar, enter the following values to create lines that define the OD profile:  
point 1: **D1=2.5, Z1= 0**  
point 2: **D2=2.5, Z= -1.5**  
Press **Enter**. A line is drawn in the **Graphics** window.  
Create a second line with the values:  
point 2: **D2=2.75, Z= -1.5**

Press **Enter**.



Create a third line:

point 2: **D2=2.75, Z= -2.0**

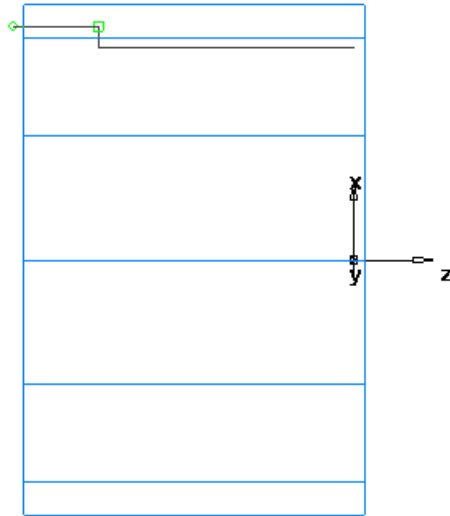
Press **Enter**. Your part now looks something like this:



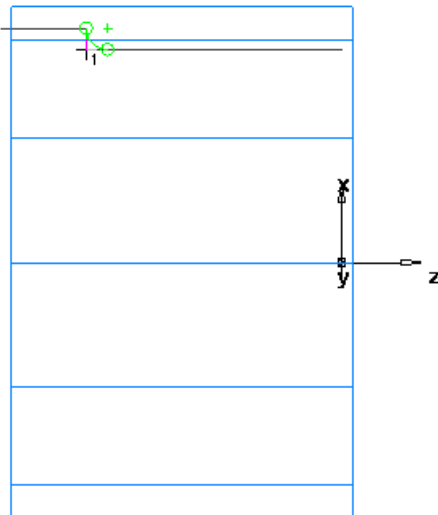

2. Create a corner fillet.

- Select the **Geometry**  step from the **Steps** panel.
- In the **Geometry Constructors** dialog, click the **Corner Fillet**  button.
- In the **Feature/Geometry Edit** bar, enter **R = 0.125**.
- Position the mouse in corner between the first and the second lines, and click. A corner fillet appears automatically trimming the lines to fit.



3. Chain the lines into curves.

- a. Select the **Curves**  step from the **Steps** panel.
- b. In the **Curves Creation** dialog, select the **Pick Curve Pieces**  button.
- c. In the **Graphics** window, click the first and third lines.

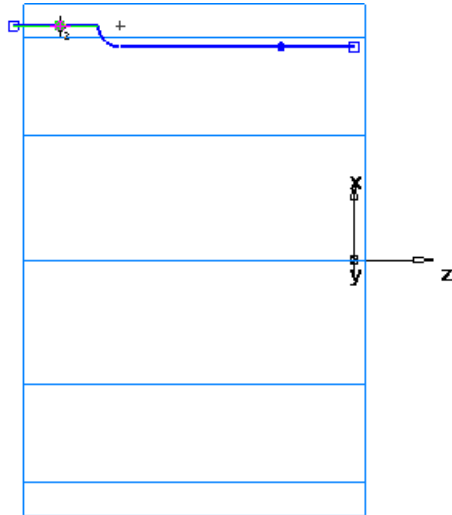

- d. In the **Feature/Geometry Edit** bar, name the curve **Turn**, and press **Enter**.
4. Create a turn feature.

- a. Select the **Features**  step from the **Steps** panel.
- b. When the **New Feature** wizard asks you which type of feature you want to create, select the **Turning** option, and click **Next**.
- c. Select **Turn** in the **From Curve** frame, and click **Next**.  
The **Turn** curve is already selected in the **Curve** field.
- d. Click the triangle next to the **Finish** button, and select the **Finish** option.

Your drawing should look something like this:

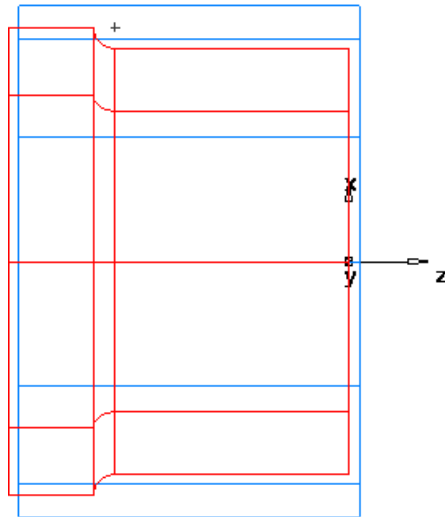

---

## Viewing

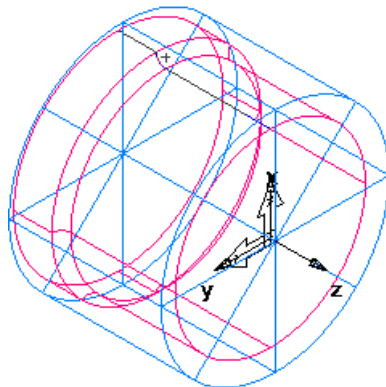

1. Click the **Isometric View**  button on the **Standard** toolbar.

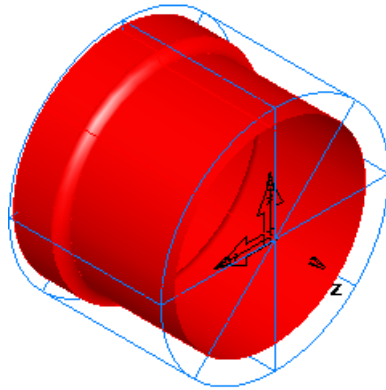

2. Open the **Part View** panel, and select **turn1** under the **Setup1** node.
3. Click the **Shade Selected**  button on the **Display Mode** toolbar to shade the feature.

If the toolbar is not displayed, select **View > Toolbars** from the **Menu** bar, and select the **Display Mode** check box in the **Customize Toolbars** dialog.



4. Click the **Unshade All**  button on the **Display Mode** toolbar to return to the line drawing view.
5. Click the triangle next to the button in the **Principal View**  menu in the **Standard** toolbar, and select the **Top** option.



---

## Creating a radial hole pattern on the face

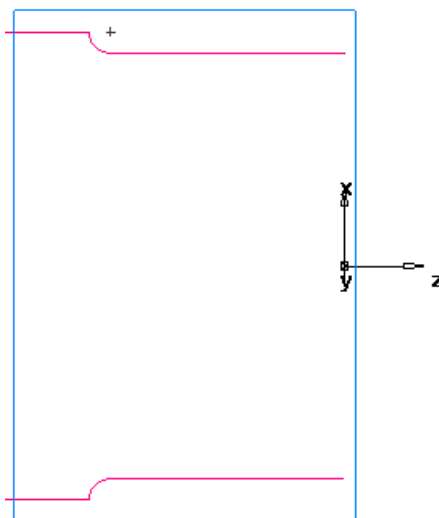
1. Use the **2D Turned Profiles**  button, on the **Display Mode** toolbar, to switch to a simplified 2D representation of your part.



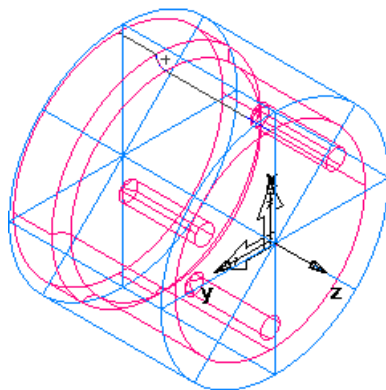

2. Create a hole.
  - a. Select the **Features**  step from the **Steps** panel.

- b. When the **New Feature** wizard asks you which type of feature you want to create, select the **Turn/Mill** option, and click **Next**.
  - c. Select **Hole** in the **From Dimensions** field and click **Next**.
  - d. Set **Chamfer** to **0.0**, **Depth** to **1.0**, and **Diameter** to **0.25**.
  - e. Click the triangle next to the **Finish** button, and select the **Finish** option.
3. Create a pattern from feature:
- a. Select the **Features**  step from the **Steps** panel.
  - b. When the **New Feature** wizard asks you which type of feature you want to create, select the **Turn/Mill** option, and click **Next**.
  - c. Select **Pattern** in the **From Feature** field and click **Next**.
  - d. Select the hole you just created to create the pattern from and click **Next**.
  - e. Select the **Radial in the setup XY plane** option, and click **Next**.
  - f. On the **Pattern - Dimensions** page, set **Number** to **3.0**, **Diameter** to **2.0**, **Spacing Angle** to **120**, and **Angle** to **60**.
  - g. Click the triangle next to the **Finish** button, and select the **Finish** option.
4. View the results.
- a. Click the **2D Turned Profiles**  button, on the **Display Mode** toolbar, to return to 3D line drawing view.
  - b. Click the **Isometric View**  button on the **Standard** toolbar.  
Your drawing should look something like this:



# Engraving on the face

1. Create a curve.

- a. Select the **Curves**  step from the **Steps** panel.
- b. In the **Curves Creation** dialog, select the **Curve Wizard**  button.
- c. In the **Curve** wizard, select **Other methods** as the construction method, **Text** as the constructor, and click **Next**.

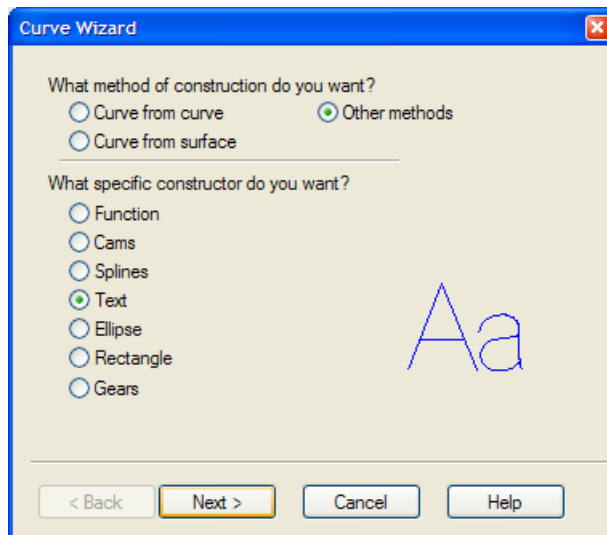

- d. On the **Engraving Text** page, configure the text properties.

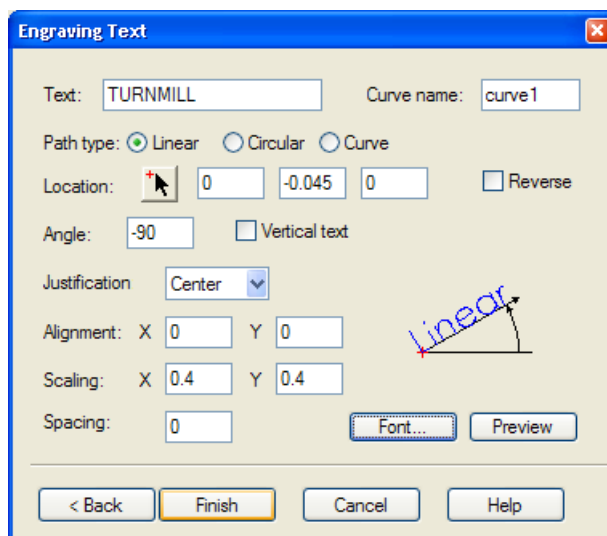

Enter **TURNMILL** as **Text**, select **Linear** as **Path type**.

Enter **0.0, -0.045, 0.0** as the **X, Y** and **Z** locations.

Enter **-90** into the **Angle** field.

Select **Center** in the **Justification** field.

Enter **0.4** for both the **X** and **Y Scaling**.

Click the **Font** button, select **Machine Tool Gothic** for the font type, and **72** for the font size in the **Font** dialog, and click **OK**.

- e. Click **Finish** to close the wizard.
2. Create a groove feature.
    - a. Select the text string (**curve1**) in the **Graphics** window, and select the **Features**  step from the **Steps** panel.
    - b. When the **New Feature** wizard asks you which type of feature you want to create, select the **Turn/Mill** option, and click **Next**.
    - c. Select **Groove** in the **From Curve** field, and click **Next** until you get to the **Dimensions** page.
    - d. On the **Dimensions** page, set **Width** to **0.0625**, **Depth** to **0.02**, and ensure that the **Simple** option and the **Face** option are selected.
    - e. Click the triangle next to the **Finish** button, and select the **Finish** option.

Your part should look similar to this:

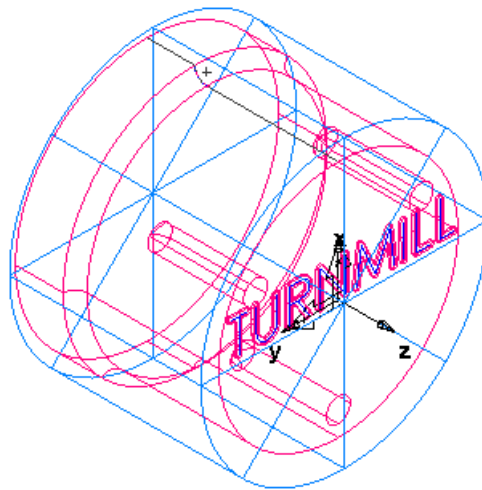



---

## Creating a pattern of wrapped slots

1. Select the **Features**  step from the **Steps** panel.
2. Select **Turn/Mill** as the feature type, and click **Next**.
3. Select **Slot** in the **From Dimensions** frame, select the **Make a pattern from this feature** option, and click **Next**.
4. Set **Length** to 1.0, **Width** to 0.5, **Depth** to 0.25, and click **Next**.
5. Select the **Radial around index axis** option, and click **Next**.
6. Set **B Angle** to 90, **Radius** to 1.25, **Z** to 0.25 and click **Next**.
7. Set **Number** to 3 and **Spacing Angle** to 120.
8. Click the triangle next to the **Finish** button, and select the **Finish** option.

Your part should look something like this:

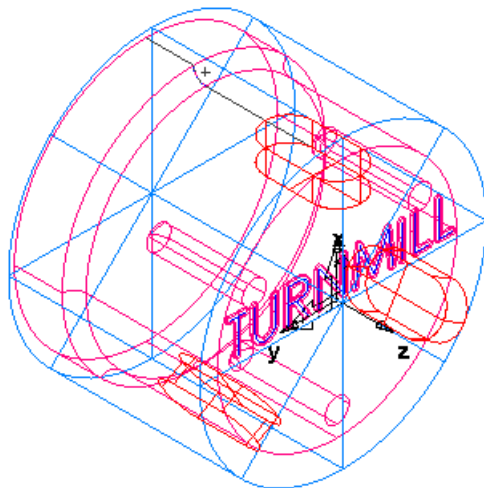

---

## Simulating a turn/mill part

1. Select the **Toolpaths**  step from the **Steps** panel. The **Simulation** toolbar is displayed.
2. Click the **3D Simulation**  button, and then click the **Play**  button to start the simulation. If the **Automatic Ordering Options** dialog appears, click **OK** to close it.

A solid 3D rendering of the cutting process is displayed. Notice how the toolpaths are accurately simulated including the part rotations.



*FeatureCAM runs simulations best in 256 color mode or higher. Depending on your video settings, you might see a warning about this. You may ignore this warning for this tutorial.*

3. Click **Eject** . The **Simulation** toolbar is removed from the screen.

You have completed this tutorial. If you want to see more examples of turn/mill parts, look in the **Examples/Turnmill** folder.

# Creating features from 3D CAD models



*You must have MILL with the RECOGNITION option or MILL3D to perform this tutorial. You also need the Solid plugin installed.*

*This tutorial is only available in metric units.*

In this tutorial you will learn how to:

- Import 3D models.
- Dynamically shade 3D models.
- Create features directly from 3D solid models using both automatic feature recognition and more interactive methods.

---

## Getting started



*You must have metric tools loaded into the tool database to perform this tutorial.*

### To add metric tools to your database:

1. Select **Exit** from the **File** menu to close FeatureCAM.
2. From the **Start** menu, select **All Programs > FeatureCAM > INITDB**.



*You can also run **initdb.exe** from the folder where FeatureCAM is installed.*

3. In the **Tool and Material Setup** dialog, select the **On my local computer** option, and click **Next**.

4. Select **Both** as the tools to load, and click **Next**.
5. Select **Inch** or **Metric** to indicate which tool type you use more often, and click **Next**.
6. Click **Finish**.

---

## Importing the CAD model

1. Start FeatureCAM by double-clicking the FeatureCAM icon  on the desktop.
2. If the **New Part Document** wizard is displayed, select the **New file** option, and click **Next**. Select **Milling Setup**, click **Millimeter**, and click **Finish**.

If the **New Part Document** wizard is not displayed, select **File > New** from the menu. Select **Milling Setup**, click **Millimeter**, and click **OK**.

3. In the **Stock** wizard (**Dimensions** page), click the triangle next to the **Finish** button, and select the **Finish** option.
4. Select **File > Import/Export Options** from the menu.
5. In the **Import/Export Options** dialog, select the **Center stock automatically** option on the **General** tab.

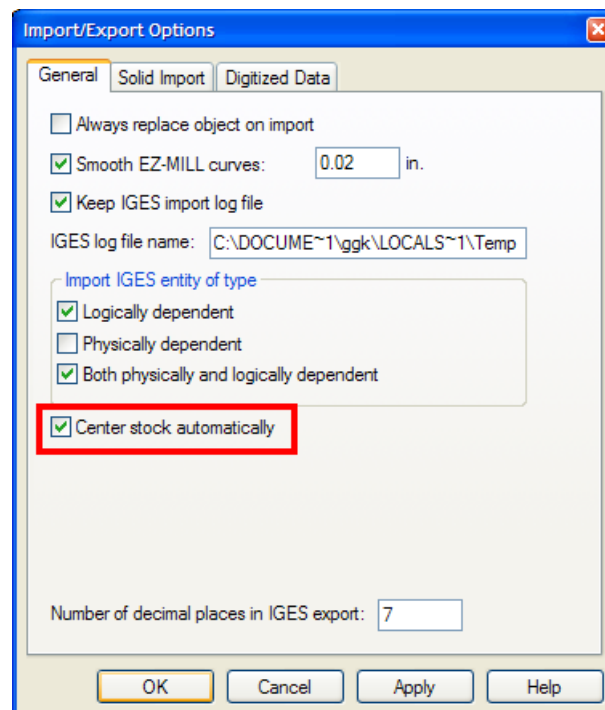

6. Click the **Solid Import** tab, ensure the **Import file as solids** option is selected, and click **OK**.

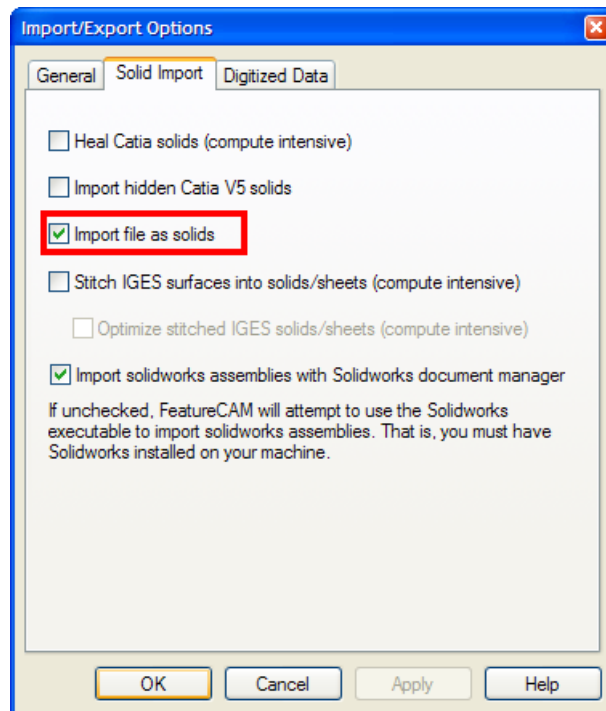

7. Select **File > Import** from the menu.
8. In the **Import** dialog, select **Acis** as **Files of type**, and open the file **Tutor9.sat**.

If you installed FeatureCAM in the default folder, the file should be in **C:\Program Files\FeatureCAM\Examples\Tutorials\3D models**.

9. In the **Import Results** wizard, select the **Use the wizard...** option, and keep clicking **Next** until you get to the **Stock Dimensions** page.
10. Select **Use the wizard** option in the **Import Results** dialog and keep clicking **Next** until you get to the **Stock Dimensions** page.
11. Select **Compute stock size from the size of the part**, ensure all of the **Extra stock size** fields are set to **0** and click **Finish**.

12. The imported part should look something like this:

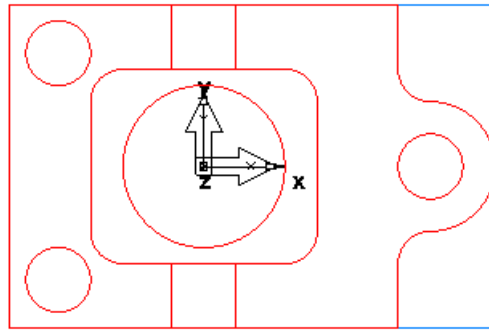

## Aligning the model

1. Open the **Part View** panel, and select **solid1** under the **Solids** node.

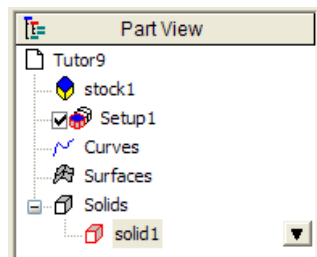

This is the solid model you have just imported.

2. Click the **Isometric View**  button on the **Standard** toolbar. The stock has been resized, but the setup is located at the center of the stock.

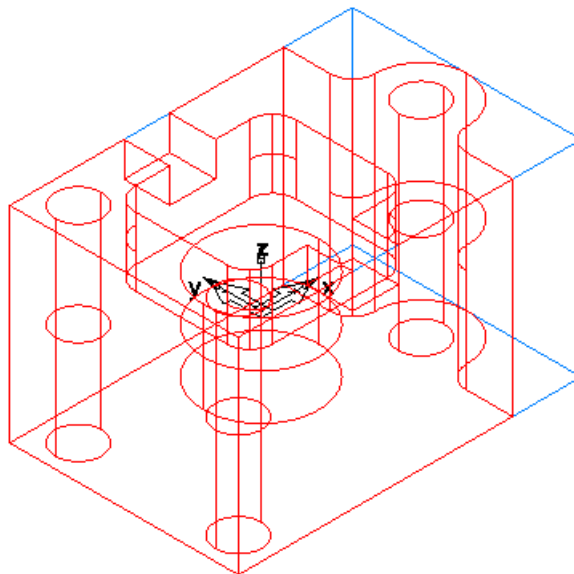

3. Click the **Setups**  button on the **Advanced** toolbar.



If the **Advanced** toolbar is not displayed, select **View > Toolbars** from the menu, select the **Advanced** option in the **Customize Toolbars** dialog, and click **OK**.

4. In the **Setups** dialog, select **Setup1** from the list, and click **Edit**.

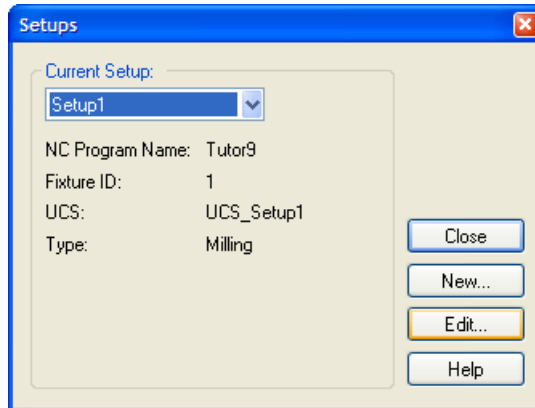

5. In the **Setup** wizard, click **Next** to get to the **Setup - Part Program Zero** page, select **Align to Stock Face**, and click **Next**.

6. Click the **LL**  button in the **XYZ Location** section.

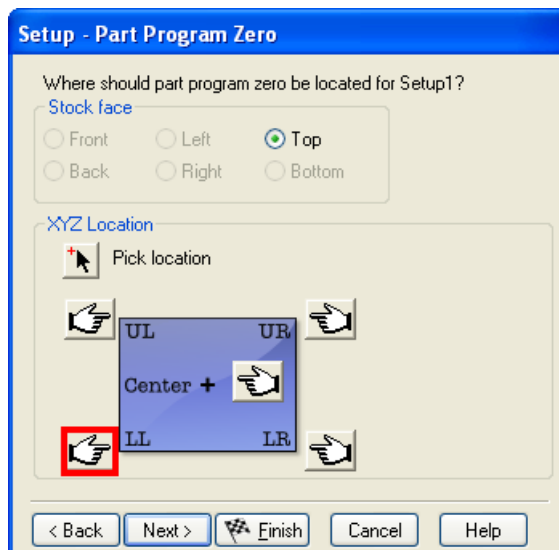

7. Click **Finish** to close the wizard, and click **Close** to exit the **Setups** dialog.

The stock has now been aligned to the stock face.

8. Select **Manufacturing > Set Tool Crib** from the menu.
9. In the **Select Active Tool Crib** dialog, select the **tools** crib, and click **OK**.

---

# Shading the part

1. Click the **Shade**  button on the **Standard** toolbar to shade the part.

This shaded view makes it easier to see the cavities in the model. Remember, at this point the part model contains only surfaces.

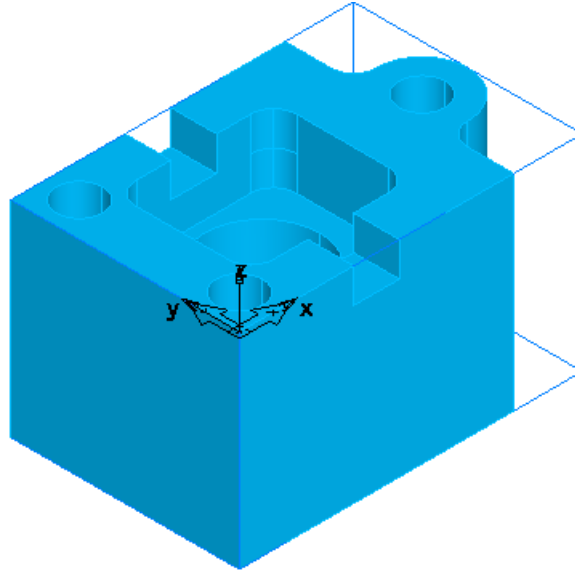

2. Click the **Shade**  button again to turn off the shading.



---



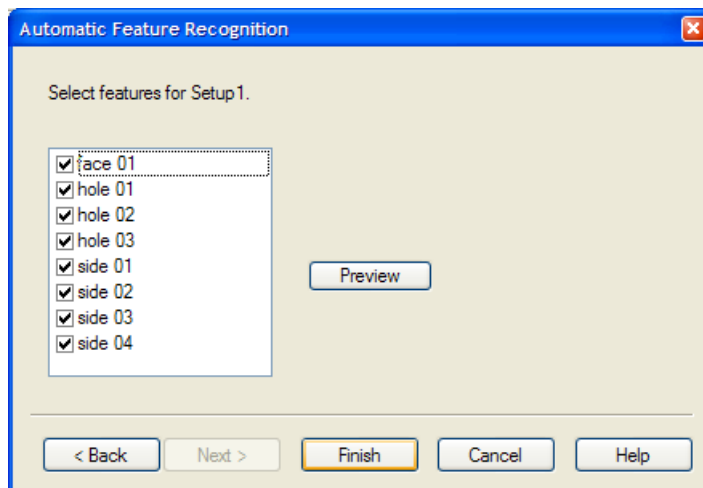

# Automatic feature recognition

This entire part can be automatically recognized using the automatic feature recognition (AFR) wizard.

1. Select the **AFR**  step from the **Steps** panel.
2. In the **Automatic Feature Recognition** wizard, click the **Next** button twice.



The features that were recognized are listed.

3. Click the **Finish** button.
4. Select the **Toolpaths**  step from the **Steps** panel. The **Simulation** toolbar is displayed.
5. Click the **3D**  button, and then click the **Play**  button to start the simulation. If the **Automatic Ordering Options** dialog appears, click **OK** to close it.
6. Click **Eject** .



*All features of the model were automatically recognized and the part is ready to cut. With many parts automatic feature recognition is all you need to program your part, but with others, you may need to use some of the other feature recognition (FR) techniques.*

7. Click the **Undo**  button to remove the features you created so far. You are now ready to try additional recognition methods.

---

# Recognizing holes

1. Select the **Features**  step from the **Steps** panel.
2. In the **New Feature** wizard, select **Hole** in the **From Dimensions** frame, select the **Extract with RECOGNITION** option, and click **Next** twice.

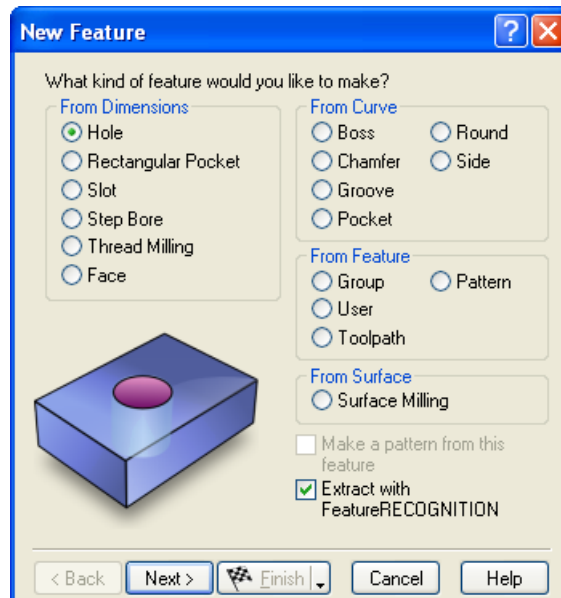

3. Select **Recognize and construct multiple holes**, and click **Next**.

The holes that are automatically recognized are shown on the screen. Three holes were recognized along with the circular pocket in the middle.

- In the **Graphics** window, ignore the central pocket, and use the mouse to select the holes. (You may need to move the wizard out of the way by dragging its title bar.)

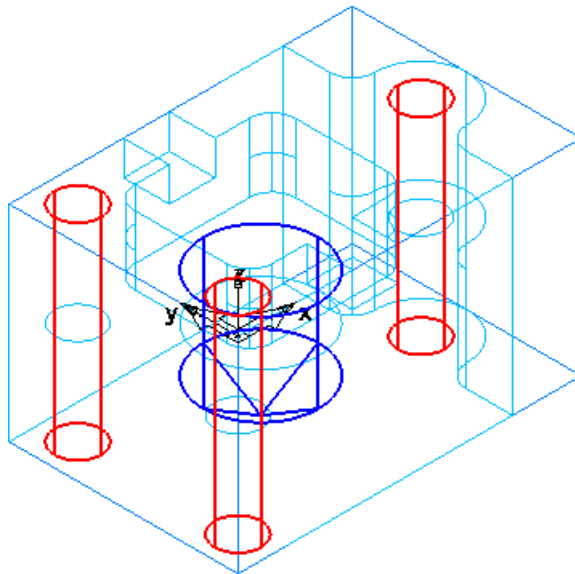

- Click the triangle next to the **Finish** button, and select the **Finish** option.



The three holes have now been recognized.

- Click the **Ordering Options**  button on the **Op List** tab.

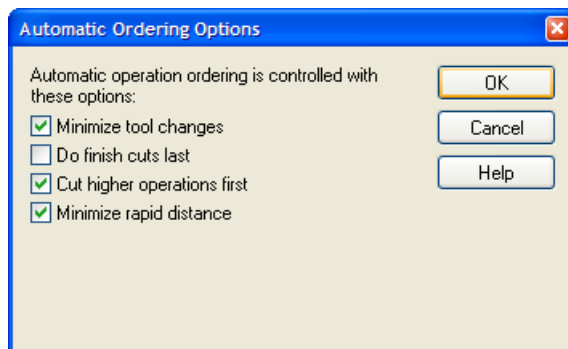
- In the **Automatic Ordering Options** dialog, select **Minimize tool changes**, **Cut higher operations first** and **Minimize rapid distance**, and click **OK**.



- Select the **Toolpaths**  step from the **Steps** panel. The **Simulation** toolbar is displayed.

- Click the **3D Simulation**  button, and then click the **Play**  button to start the simulation.

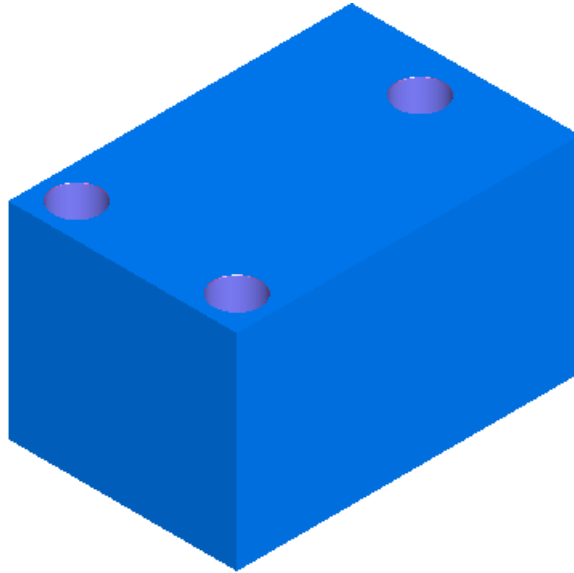

- Click **Eject** .

---

## Recognizing pockets

- Select the **Features**  step from the **Steps** panel.
- In the **New Feature** wizard, select **Pocket** in the **From Curve** frame, select the **Extract with RECOGNITION** option, and click **Next**.

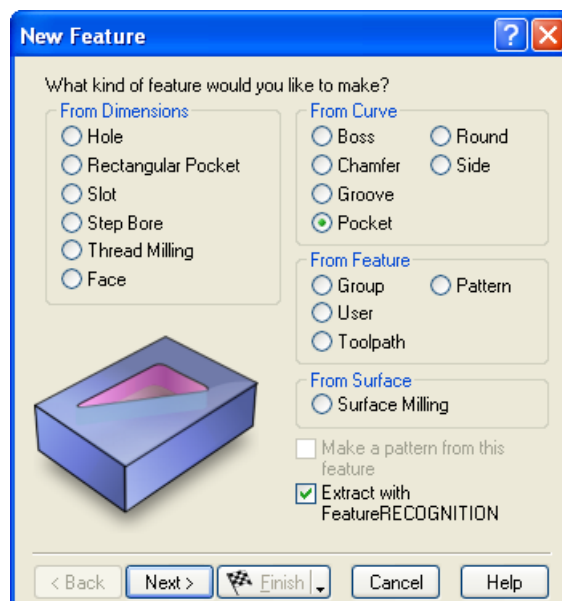

- Select **Automatic recognition**, and click **Next**.

The pockets that are automatically recognized are shown on the screen.

4. Click the **Select All** button, and click **Finish**.  
Both pockets have now been recognized.

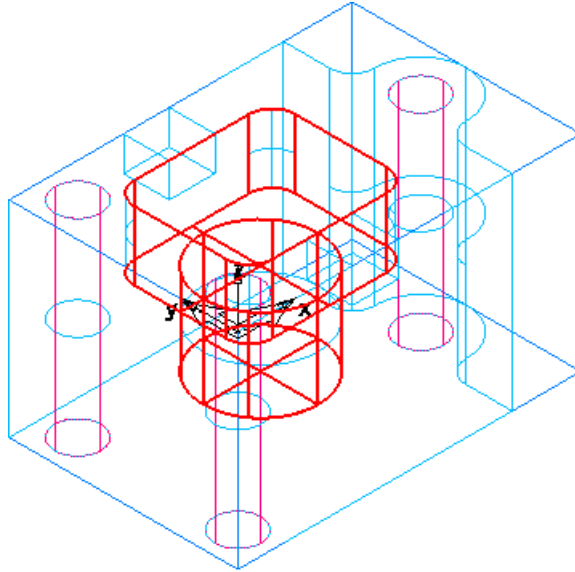

5. Select the **Toolpaths**  step from the **Steps** panel. The **Simulation** toolbar is displayed.
6. Click the **3D Simulation**  button, and then click the **Play**  button.

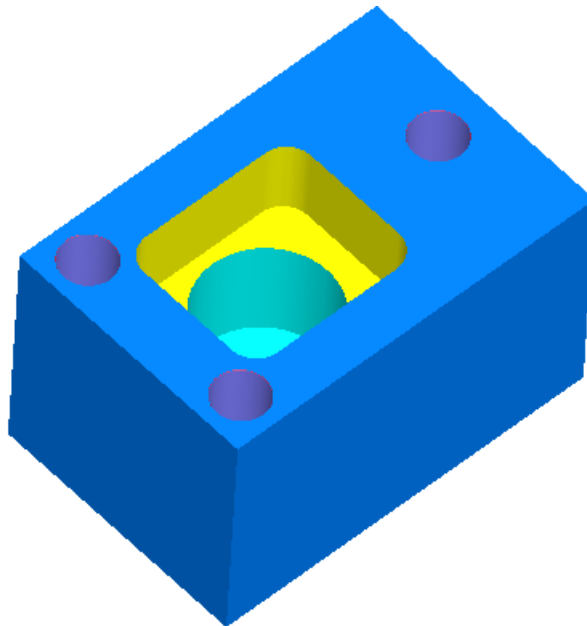

7. Click **Eject** .

# Creating a slot feature

1. Select the **Features**  step from the **Steps** panel.
2. In the **New Feature** wizard, select **Slot** in the **From Dimensions** frame, select the **Extract with RECOGNITION** option, and click **Next**.

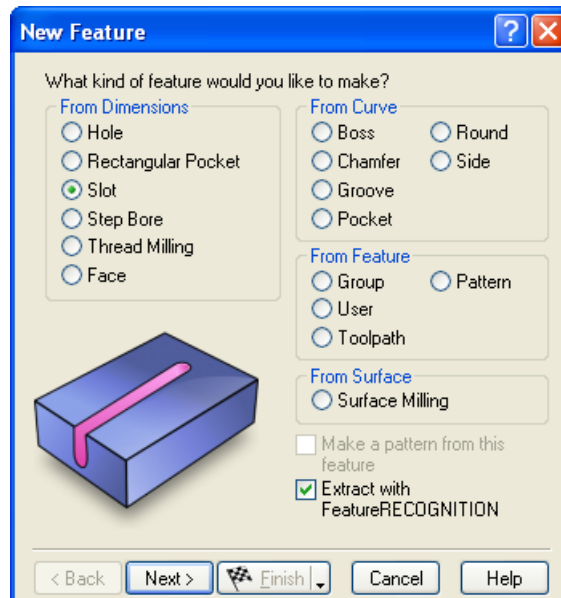

3. Click the **Pick surface**  button, and select the first location as shown below.

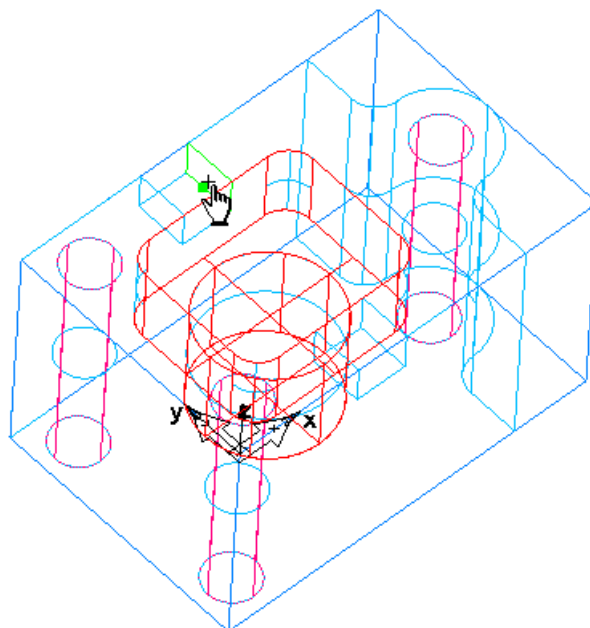

If the **Select** dialog opens, select the name that corresponds to the surface at this location, and click **OK**. The surfaces are highlighted in the graphics window as you select the names.

4. Click the **Pick surface**  button again, and select the second location as shown below.

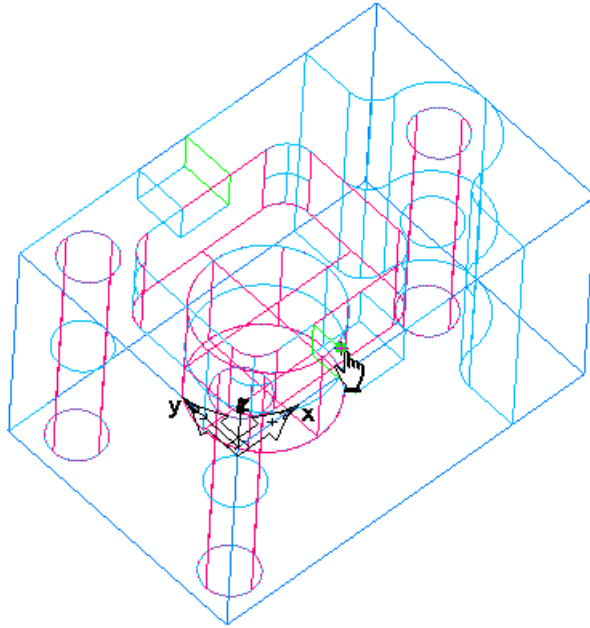



5. Click **Next**, review the extracted slot dimensions, and click **Finish**.

---

## Creating a side feature

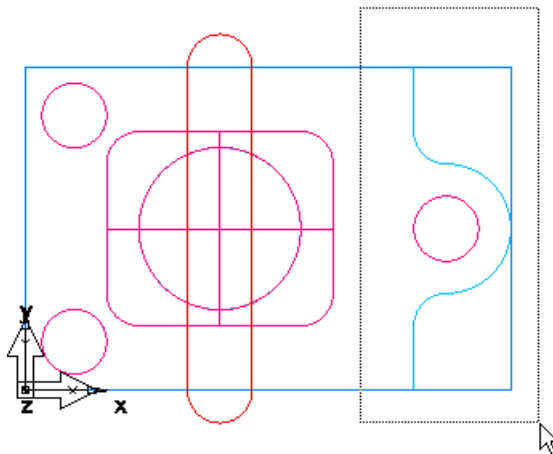
1. Click the triangle next to the button in the **Principal View**  menu in the **Standard** toolbar, and select the **Top** option.
2. Box-select the region shown below. To do this, click the left mouse button and drag the mouse before releasing the button.



3. Select **Isometric** from the **Principal View**  menu.
4. Click the **Shade**  button, on the **Standard** toolbar, to shade the part. The shaded view makes it easier to select faces on the surface.
5. Hold down the **Shift** key and click the side of the hole pattern that is selected as shown in the image.

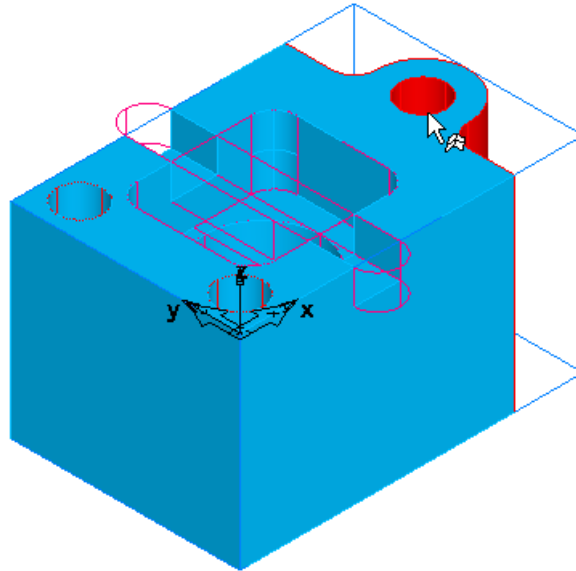

This removes the hole pattern from the selected group.

6. Select the **Features**  step from the **Steps** panel.
7. In the **New Feature** wizard, select **Side** in the **From Curve** frame, select the **Extract with RECOGNITION** option, and click **Next**.

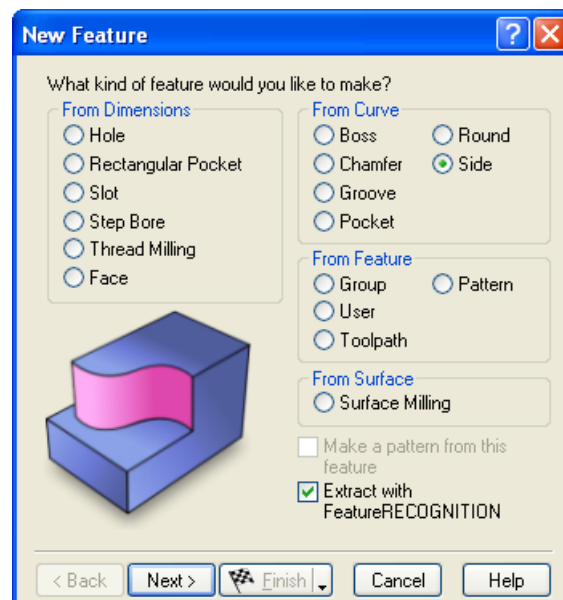



8. On the **Feature Extraction** page, choose the **Select Side Surfaces** method, and click **Next** twice to get to the **Machining Side** page.
9. The blue arrow in the **Graphics** window should point to the outside of the part (to the side you wish to cut).

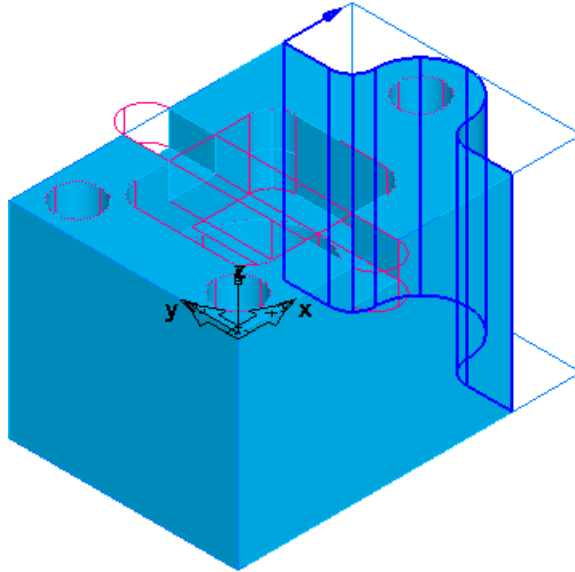

If it points to the inside of the part, click the **Switch Machining Side**  button to reverse the machining side.

10. Click **Finish**.

---

## Simulating the entire part

1. Select the **Toolpaths**  step from the **Steps** panel. The **Simulation** toolbar is displayed.

2. Click the **3D Simulation**  button, and then click the **Play**  button.

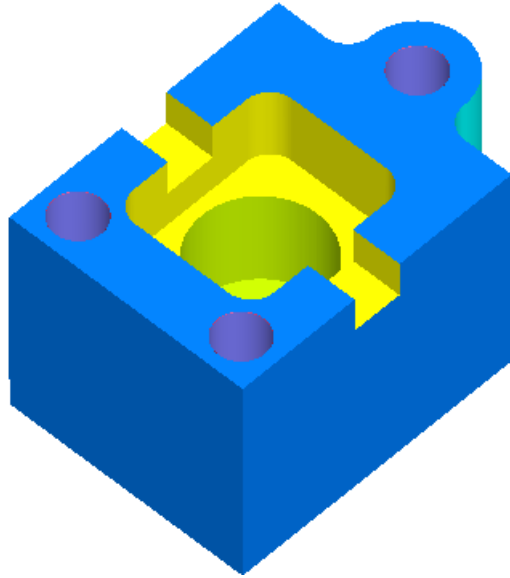

3. Click **Eject**  at the completion of the simulation.

You have completed this tutorial. The features for the entire part have been created directly from the surfaces of the solid model. Using FeatureCAM's feature-based manufacturing automation, this part can be created quickly and easily.

# Introduction to 3D milling



*You must have MILL3D to perform the examples in this chapter. These examples are only specified in inch units. You must have the basic tool crib installed.*

This tutorial introduces you to:

- Modeling 3D surfaces.
- Manufacturing surfaces using surface milling features.
- Manufacturing operations.
- Tool selection.
- 3D manufacturing attributes.

---

## Getting started

1. Start FeatureCAM by double-clicking the FeatureCAM icon  on the desktop.
2. If the **New Part Document** wizard is displayed, select the **New file** option, and click **Next**. Select **Milling Setup**, click **Inch**, and click **Finish**.
3. If the **New Part Document** wizard is not displayed, select **File > New** from the menu. Select **Milling Setup**, click **Inch**, and click **Finish**.
4. In the **Stock** wizard (**Dimensions** page), enter **3** for **Width**, **6.25** for **Length**, and **2.0** for **Thickness**.



*A milling setup defaults to a block stock.*

5. Click the triangle next to the **Finish** button, and select the **Finish** option.
6. Select **View > Toolbars** from the **Menu** bar, ensure that the **Advanced** and **Geometry** check boxes are selected in the **Customize Toolbars** dialog, and click **OK**.
7. Create three vertical lines.
  - a. Select **Vertical** from the **Line**  menu on the **Geometry** toolbar.
  - b. In the **Feature/Geometry Edit** bar, enter **1.0** for **X**, **0.0** for **Z**, and press **Enter**.
  - c. Create two more lines at **X= 5.25** and **X = 6.0**.

Your part should look something like this:

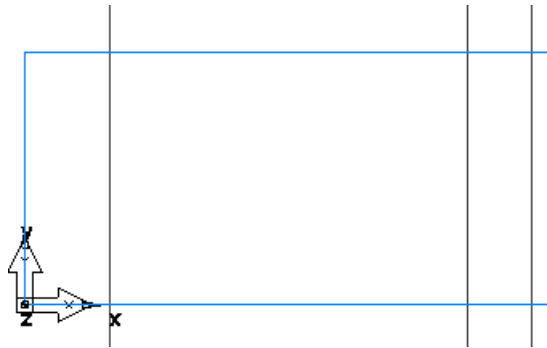

8. Create three horizontal lines.
  - a. Select **Horizontal** from the **Line**  menu on the **Geometry** toolbar.
  - b. Create horizontal lines at **Y= 0.5**, **1.125**, and **1.5**, and **Z = 0**.

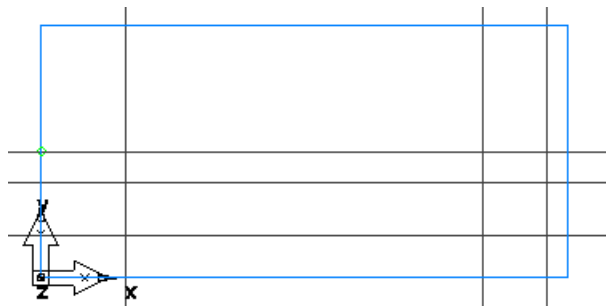

9. Create a through line.
  - a. Select **Pt, Angle** from the **Line**  menu on the **Geometry** toolbar.
  - b. In the **Feature/Geometry Edit** bar, enter **30** as the angle.

- c. In the **Graphics** window, click at the intersection between the second horizontal and second vertical lines to create a through line.

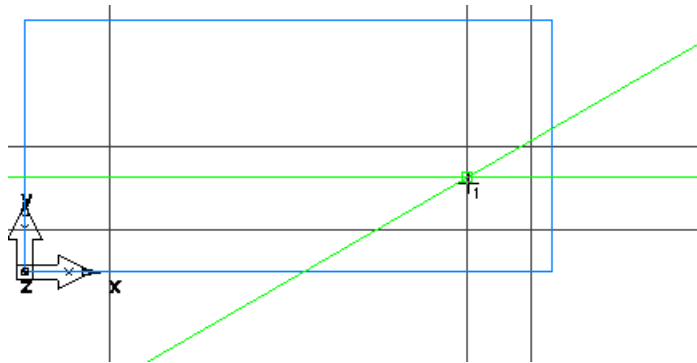

10. Create arcs.

- a. Select **2 Pts, Radius** from the **Arc**  menu on the **Geometry** toolbar.
- b. In the **Feature/Geometry Edit** bar, enter **R = 0.5**, and click immediately below the intersection between the first vertical line and the second horizontal line to create the first arc point. Click to the right of the intersection between the first vertical line and the third horizontal line to create the first arc.

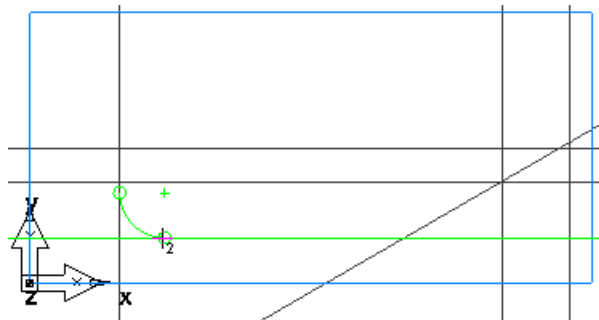

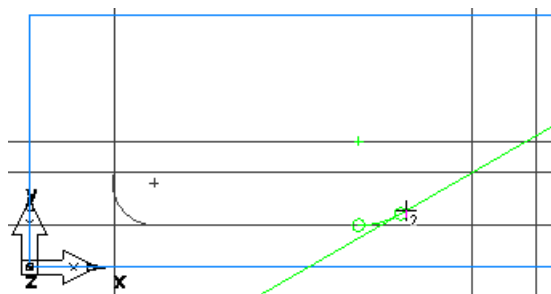

- c. In the **Feature/Geometry Edit** bar, enter **R = 1.0**, and click the third horizontal line just to the left of the intersection with the through line to create the first arc point. Click the through line just above and to the right of the intersection to create the second arc.

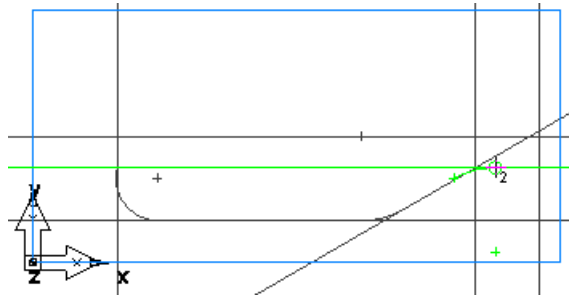

- d. Click the through line just to the left of the intersection with the second vertical line to create the first arc point. Click on the second horizontal line just to the right of the intersection with the through line to create the third arc.



#### 11.Chain geometry into curves.

- a. Select the **Curves**  step from the **Steps** panel.
- b. In the **Curves Creation** dialog, select the **Pick Curve Pieces**  button.
- c. Click the intersection between the third vertical line and the second horizontal line.
- d. Click the intersection between the first vertical and the first horizontal lines.

Your part should look something like this:

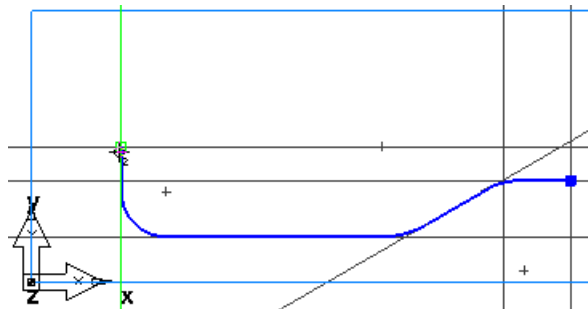

## Creating the bottle surface

1. Click the **Surfaces**  step from the **Steps** panel.
2. In the **Surface** wizard, click **Surface of Revolution**, and click **Next**.
3. On the **Surface of Revolution** page, enter **0.0** for **Start Angle**, and **180** for **End Angle**.

The curve you chained is automatically selected in the **Curve** field.

4. Click the **Pick line**  button in the **Axis** field, and select the first horizontal line (the one at  $Y=1.5$ ).

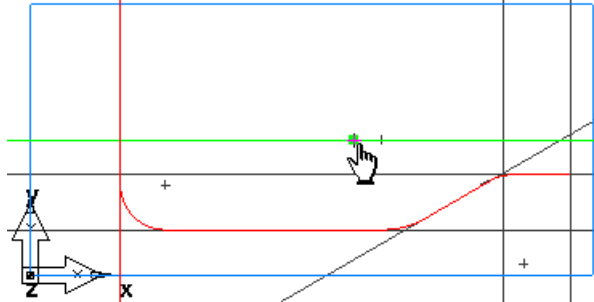

5. Click **Finish**.

Your part now looks something like this:

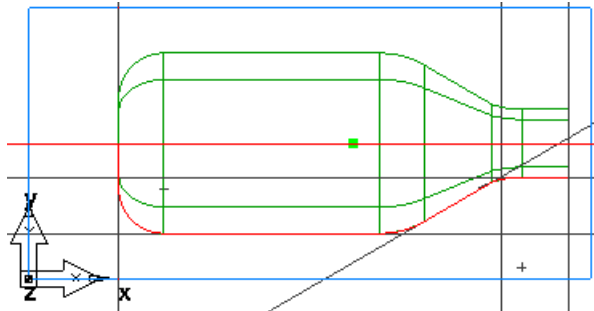

## Viewing

1. Click the **Isometric View**  button on the **Standard** toolbar.

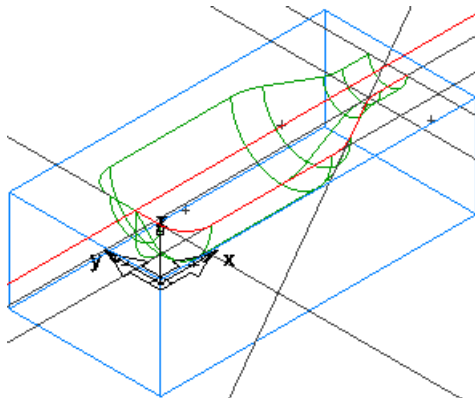

2. Use the **Viewing Options** dialog to control how the part is displayed.
  - a. Select **Options > Viewing** from the menu to open the **Viewing Options** dialog.

- b. Select the **Show surface boundaries only** option, and click **Apply**.



With this option enabled, surfaces are displayed as only their outer boundaries and trimmed loops. No additional lines will be drawn in the interior of the surface. This option makes the display of larger models much faster.

- c. Now deselect the **Show surface boundaries only** option, and click **Apply**.

You should now see your part drawn with lines in the interior of the surface. For large models, this option makes the display of the part slower.

- d. Enter **20** for **Wireframe**, and click **Apply**.

The surface is now drawn with more lines. Decreasing the value of **Surface Fineness** improves the display quality but can slow down the graphics.

3. Select the **Hide All Geometry** option from the **Hide**  menu on the **Advanced** toolbar.
4. Click the **Shade**  button, on the **Standard** toolbar, to shade the part.

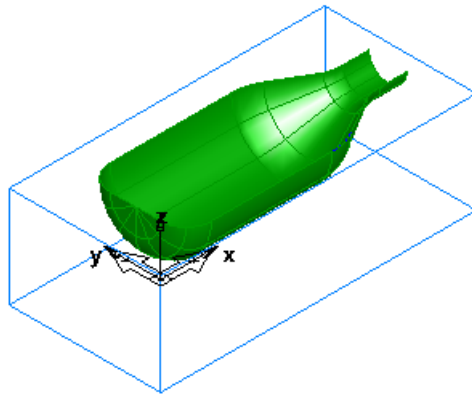





# Creating a surface milling feature

To mill 3D surfaces you must create a surface milling feature. A surface milling feature lets you generate toolpaths for multiple surfaces using a number of 3D toolpath strategies.

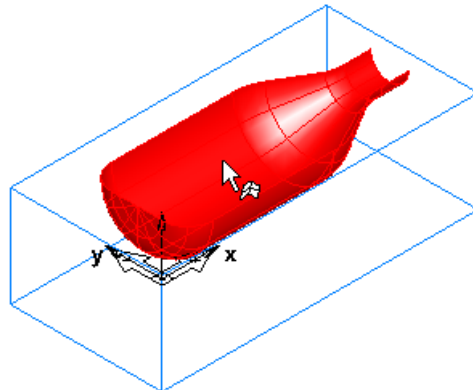
1. Click the **Select**  button, on the **Standard** toolbar, and select the surface (**srf1**).



2. Select the **Features**  step from the **Steps** panel.
3. In the **New Feature** wizard, select the **Surface Milling** option in the **From Surface** frame.
4. Click **Next** twice to get to the **New Strategy** page, select the **Choose Rough, Semi Finish, and Finish...** option, and click **Next**.
5. On the **Rough** page, select the **Z Level Rough** option, select **Classify slices as 3D Pocket**, and click **Next**.

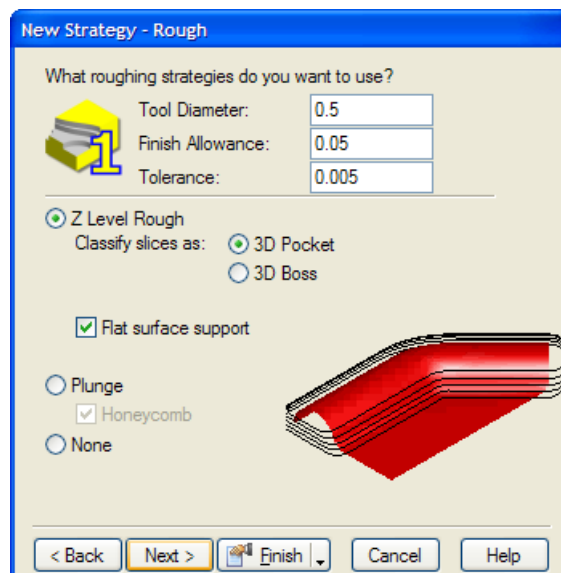

6. On the **Semi-Finish** page, select **None**, and click **Next**.

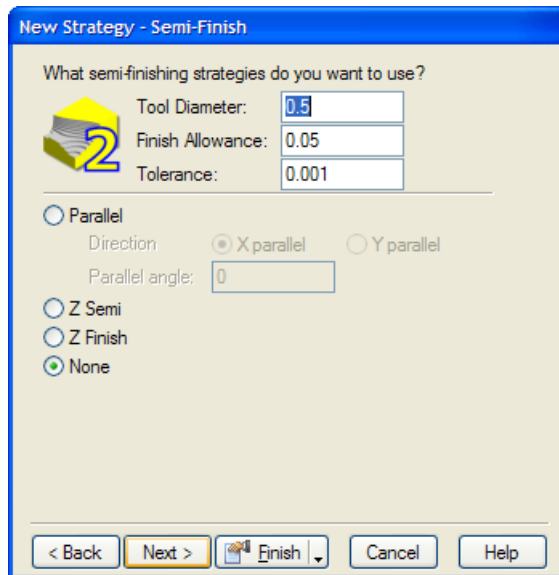

7. On the **Finish** page, select **Isoline**.

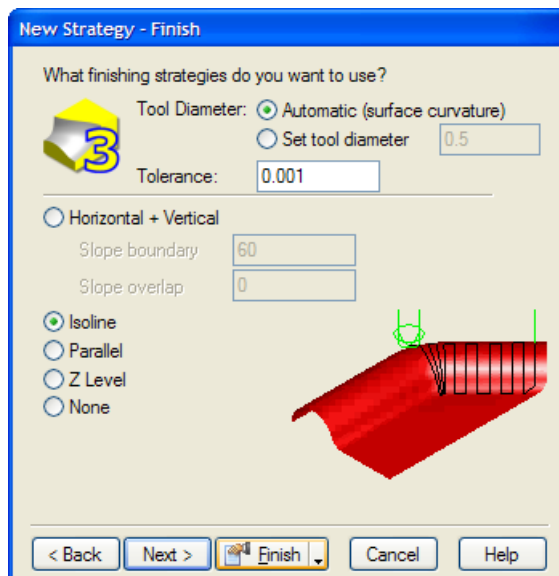



8. Click the triangle next to the **Finish** button, and select the **Finish** option.

---

## Simulating the entire part

1. Select the **Toolpaths**  step from the **Steps** panel. The **Simulation** toolbar is displayed.

2. Click the **3D**  button, and then click the **Play**  button to start the simulation. FeatureCAM prepares the model, and processes the toolpaths.

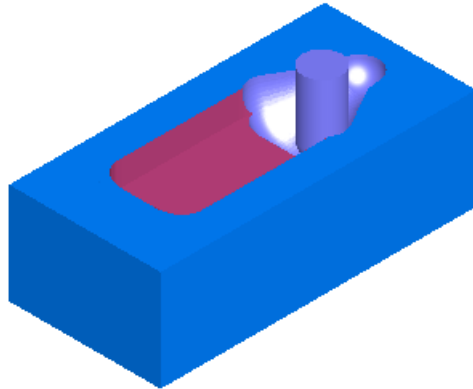

3. Click the **3D simulation**  button and click **Play** .
4. Click **Eject** . The **Simulation** toolbar is removed from the screen.

You have completed this tutorial, and can move to the next tutorial for more advanced 3D manufacturing techniques.

# Introduction to 5-axis simultaneous



*You must have 5-Axis Simultaneous and MILL3D to perform this tutorial. We recommend that you complete the Introduction to 3D milling (see page 124), Advanced 3D milling and Creating features from 3D CAD models (see page 108) tutorials before starting this one.*

*This tutorial is only available in metric units.*

In this tutorial you will learn to:

- Tilt the tool axis while cutting a 3D surface milling feature.
- Recognize and drill 5-axis holes in a single setup.

---

## Getting started

1. Start FeatureCAM by double-clicking the FeatureCAM icon  on the desktop.
2. If the **New Part Document** wizard is displayed, select the **New file** option, and click **Next**. Select **Milling Setup, Millimeter**, and click **Finish**. Close the **Stock** wizard (**Dimensions** page) by clicking the **Cancel** button.
3. If the **New Part Document** wizard is not displayed, select **File > New** from the menu. Select **Milling Setup, Millimeter, None**, and click **OK**.
4. From the **Manufacturing** menu, select **Set Tool Crib**.

5. In the **Select Active Tool Crib** dialog, select the **tools** crib, and click **OK**.

---

## Creating a surface milling feature

A 5-axis simultaneous surface milling feature requires your machine to have 5 degrees of freedom. For FeatureCAM, the 5 degrees of freedom are restricted to moving in X, Y and Z, and rotating in two single revolute rotational joints.



*A single part of your machine can only rotate about one axis. Unlike the human wrist, for example, machine joints can only rotate about one mechanical axis.*

That is, you can define 5-axis features in a Turn/Mill document with a B-axis enabled post (\*.cnc file) so that your 5 degrees of freedom are X, Y, Z, B and C. This can be used, for instance, on a Mazak Integrex lathe that has a B-axis swiveling head. You can also use 5-axis features in a 5-axis indexed milling environment in a Milling document.

### To create a surface milling feature:

1. Select **File > Import** from the menu.
2. In the **Import** dialog, select **ParaSolids** as **Files of type**, and open the file **myjayfilledholes\_untrimmed.x\_t**.  
If you installed FeatureCAM in the default folder, the file should be in **C:\Program Files\FeatureCAM\Examples\5axis simul**.
3. In the **Import Results** wizard, select the **Use the wizard** option, and keep clicking **Next** until you get to the **Stock Dimensions** page.

4. Select **Compute stock size from the size of the part**, allow 3 extra millimeters in **+Z**, and then click **Finish**.

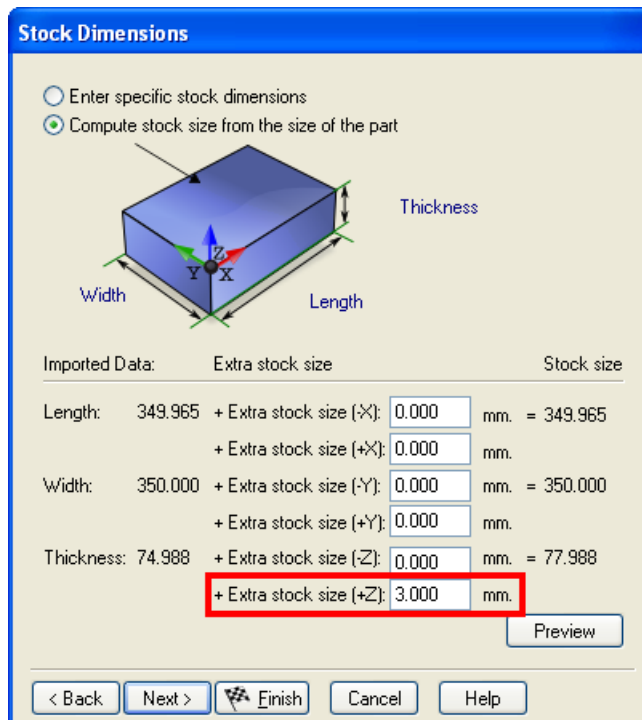

5. Cancel the **Automatic Feature Recognition** wizard, if it opens.
6. Select **Edit > Select All** from the menu.
7. Select the **Features**  step from the **Steps** panel.
8. In the **New Feature** wizard, select the **Surface Milling** option in the **From Surface** frame.
9. Click **Next** twice to get to the **New Strategy** page, select the **Choose a single operation** option, and click **Next**.

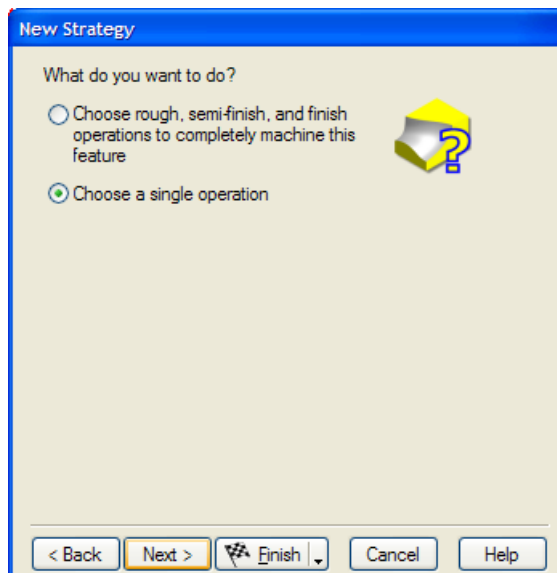

10. Select the **Z Level** option in the **Roughing Strategies** frame, and click **Next** until you reach the **Default Tool** page.

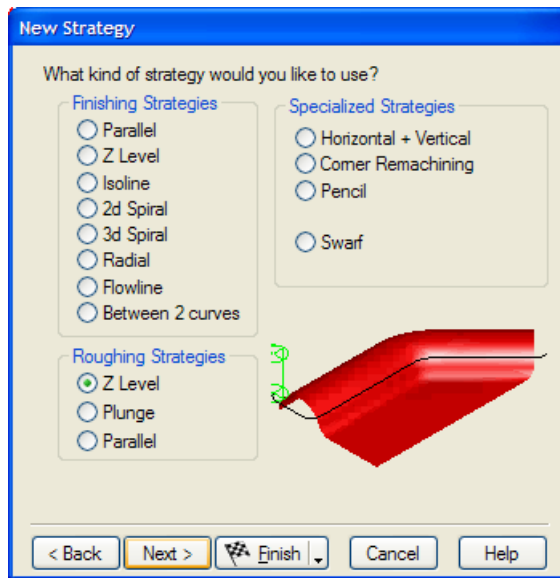

11. Select **I want to search for another tool or make a new one**, and click **Next**.

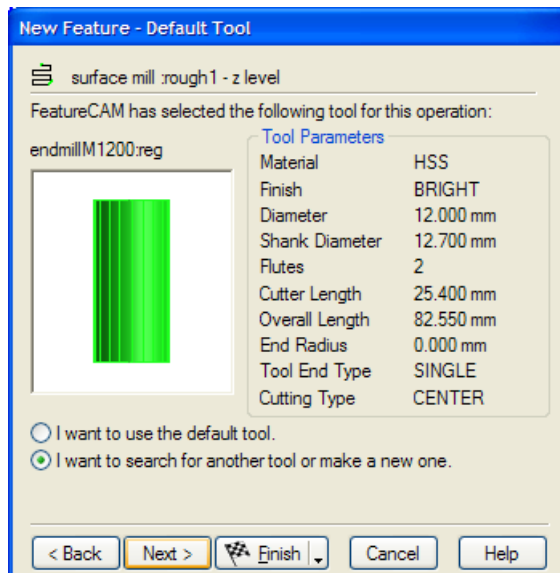

12. On the **Tool Search** page, click the **Diam.** column header to order the tools, choose the flat endmill tool with the largest diameter, and click **Finish**.

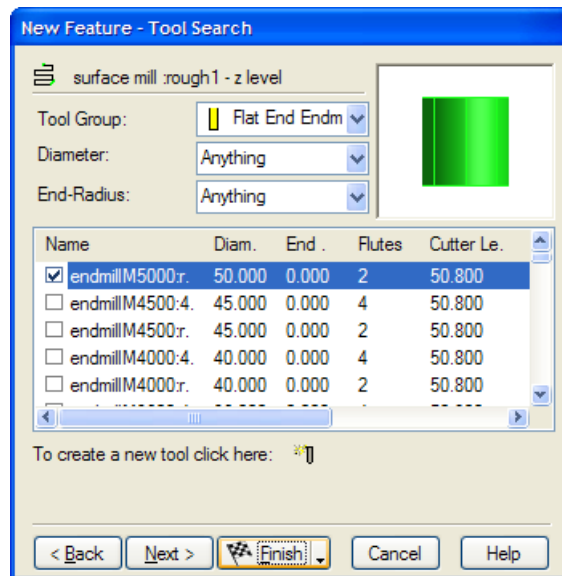

## Importing geometry

1. Select **File > Import** from the menu.
2. In the **Import** dialog, select **IGES** as **Files of type**, and open the file **myjayfilledholes\_gsg.igs**.

If you installed FeatureCAM in the default folder, the file should be in **C:\Program Files\FeatureCAM\Examples\5axis simul.**

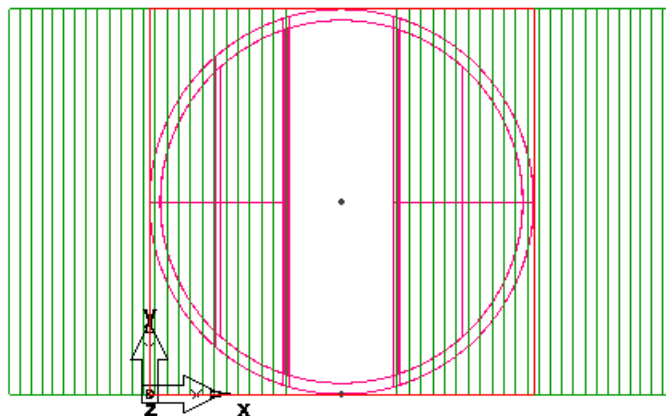

3. Select **No** when you are asked to review the IGES log.
4. In the **Import Results** wizard, select the **Accept the imported data 'as is' and exit the wizard** option, and click **Finish**.

The part with imported geometry should look something like this:





## Adding flowline operation

1. Open the **Part View** panel, select **stock1**, and on the **Feature/Geometry Edit** bar click the **Properties**  button.
2. In the **Properties** dialog for **stock1**, click the **Indexing** tab, select the **5th Axis Positioning** option, and click **OK**.
3. Select **srf\_mill1** under the **Setup1** node on the **Part View** panel, and click the **Properties**  button on the **Feature/Geometry Edit** bar.
4. In the **Properties** dialog for **srf\_mill1**, click the **Process** tab, and click the **Add new operation**  button.
5. In the **New Strategy** wizard, select **Flowline** in the **Finishing Strategies** frame, and click **Finish**.

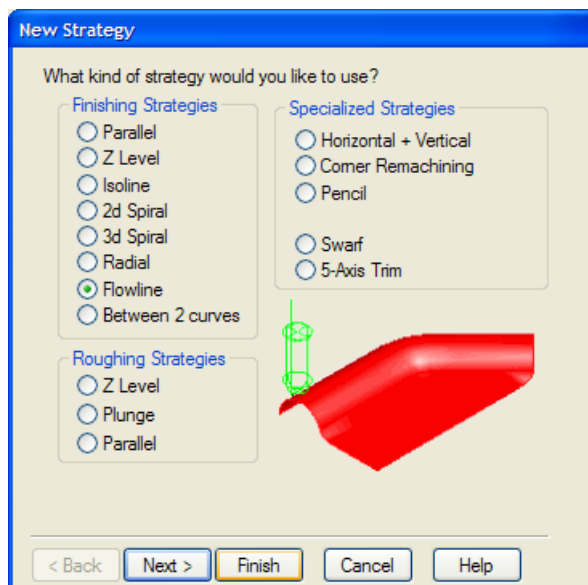

6. In the **Properties** dialog, select the **finish2** process for the **flowline** operation in the tree view.

7. Click the **Milling** tab, select the **Stepover** attribute, enter **3** as the **New Value**, and click **Set**.

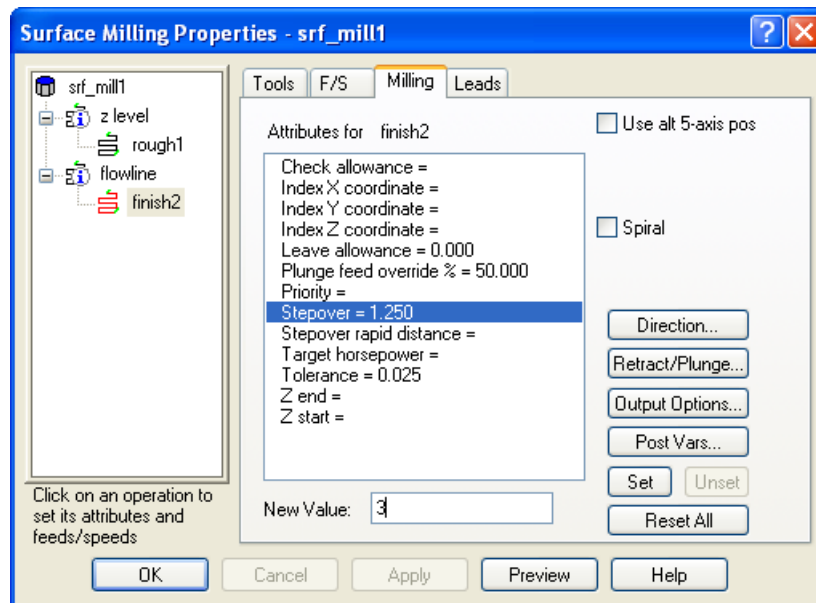

8. Add a new tool.
  - a. Click the **Tools** tab, and select **Bullnose Endmill** in the **Tool Group** field.
  - b. Select the tool with the biggest diameter, and click the **New Tool**  button.

This opens the **Tool Properties** dialog with the currently selected tool used for the initial values for the new tool.
  - c. Enter **bullnose40** as the **Name**, and **40** as the **Diameter**.

- d. Deselect the **Ball-end** check box, enter **4** as the **End Radius**, and click **OK**.

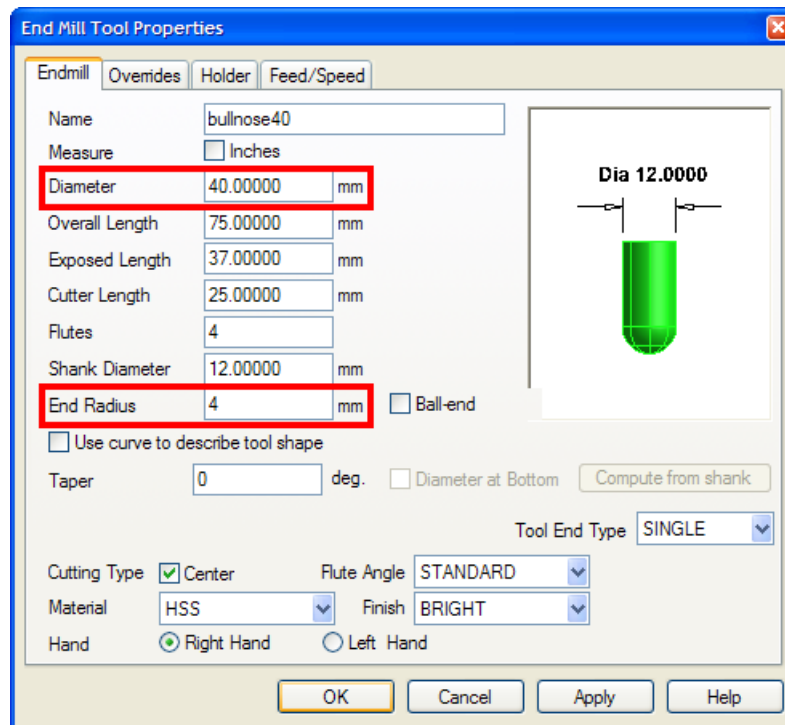

- e. Click **Yes**, when the system asks **Set the new tool as override?**

The new tool is now selected.

9. In the **Properties** dialog for **srf\_mill1**, select the **flowline** operation in the tree view.
10. Click the **5-Axis** tab, select **Use Lead and Lean**, and click **Apply**. This ensures the tool is at a fixed angle relative to the direction of the toolpath.

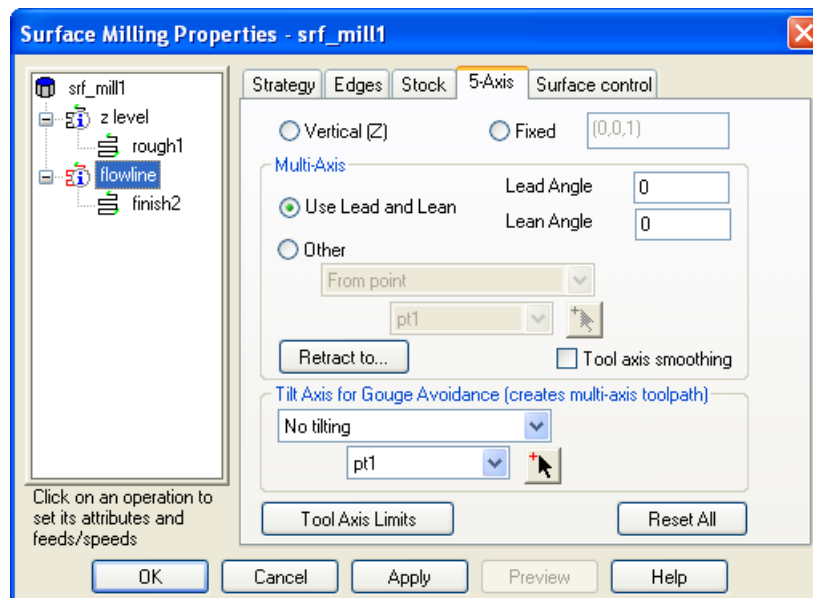

Using a lead/lean strategy keeps the tool normal to the cutting surfaces and enables you to take large stepovers while leaving a good quality finish.

11. Ensure the **Retract to cylinder** check box is not selected.

Retracting to Cylinder will retract in **X** and **Y**, and in this example, we need to retract along the **Z** vector.

12. Click the **Surface control** tab, and select the surface **<ig\_srf3>** as the **Flowline guide surface** at the bottom of the tab. (The surface name may have a different number in your file.)

13. Click the **Set Isoline Row/Col**  button until the value in the **Start Curve** column is set to **First Col**, and then click **OK**.

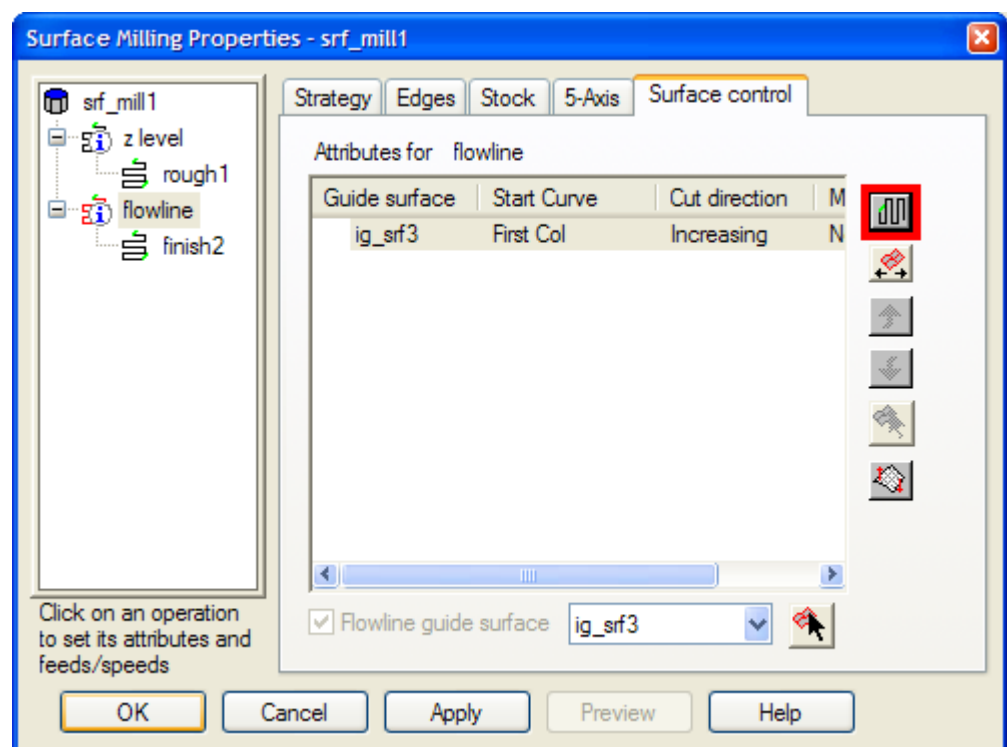

14. Select the **Toolpaths**  step from the **Steps** panel.

15. Click the **3D Simulation**  button, and then click the **Play**  button.





*The 3D simulation of 5-axis simultaneous parts can be slow. To speed up 3D simulation, select **Options > Simulation** from the **Menu** bar, and use the fields on the **2D/3D Shaded** tab in the **Simulation Options** dialog. We recommend setting a larger **Tool cutting tolerance**. Adjusting **Turn/mill angular interpolation** and **Tool visual tolerance** can also improve the simulation speed.*

To accelerate the graphics, choose **Options > Surface Shading** from the **Menu** bar, and select the **Use Graphics Hardware** option.

## Recognizing holes

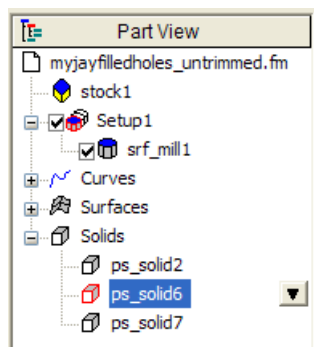
1. Select **Import** from the **File** menu.
2. In the **Import** dialog, select **ParaSolids** as **Files of type**, and open the finished ParaSolids part **myjayfilledholes\_gsg.x\_t**.  
If you installed FeatureCAM in the default folder, the file should be in **C:\Program Files\FeatureCAM\Examples\5axis simul**.
3. In the **Import Results** wizard, select the **Use the same alignment as last import** option, and click **Finish**.
4. Open the **Part View** panel, expand the **Solids** node, and select the solid part that contains holes (this should be the second solid in the list).



5. From the **Hide**  menu on the **Advanced** toolbar, select **Hide Unselected**.

The part in the **Graphics** window looks like this:

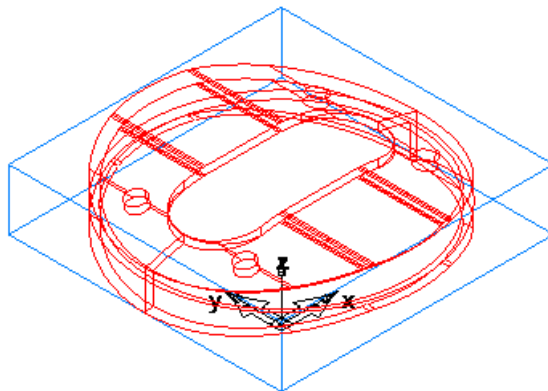

6. Select the **Features**  step from the **Steps** panel.

- In the **New Feature** wizard, select **Hole** in the **From Dimensions** frame, select the **Extract with RECOGNITION** option, and click **Next**.
- Select the **Along a specific Vector** option, select the **Recognize all holes** option, and keep clicking **Next** until you reach the **Hole Recognition Options** page.
- Click the **Select All** button, click the triangle next to the **Finish** button, and select the **Finish and Create More** option.

The part in the **Graphics** window should look something like this:

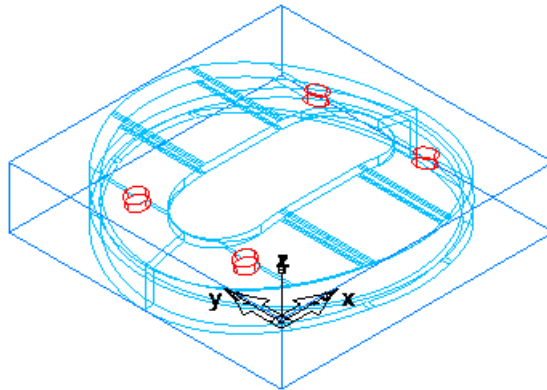

## Recognizing side features

- Return to the **New Feature** wizard, select **Side** in the **From Curve** frame, select the **Extract with RECOGNITION** option, and click **Next**.

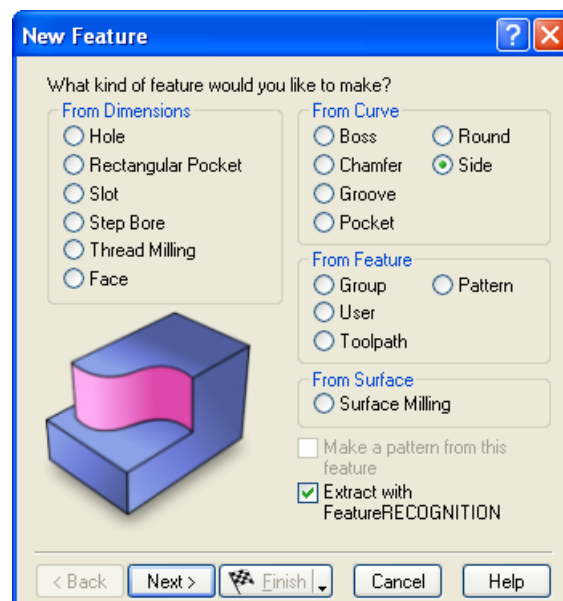

- Hide everything except the part you selected. Select **View > Hide > Hide Unselected**.

3. Select the **Automatic Recognition** option, and click **Next**.
4. Click the **Select All** button, click the triangle next to the **Finish** button, and select the **Finish** option. The part in the **Graphics** wizard looks something like this:
5. Open the **Part View** panel, and right-click the first side feature (**side1**) under the **Setup1** node.

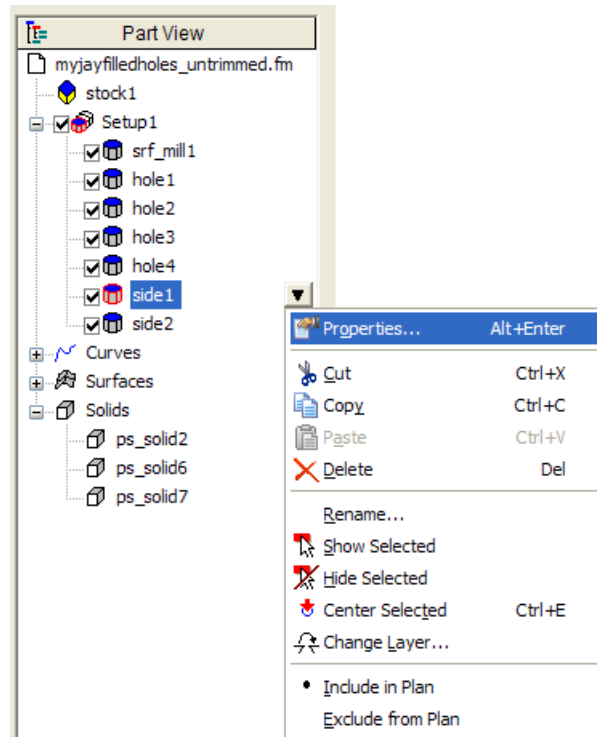

6. In the **Properties** dialog for **side1**, click the **Strategy** tab, deselect the **Rough** check box, and click **OK**.

This is the outer side feature, and, therefore, it does not need to be roughed.

7. Select the **Toolpaths**  step from the **Steps** panel.

8. Click the **3D Simulation**  button, and then click the **Play**  button.

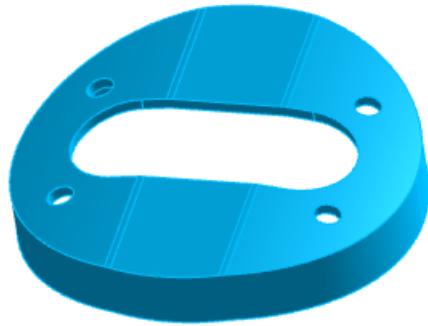

You have completed this tutorial.



# Solid modeling basics



*You must have the Solid Modeling option to perform this tutorial.*

This tutorial introduces you to the solid modeling capabilities of FeatureCAM by creating a model of the simple computer speaker shown below.

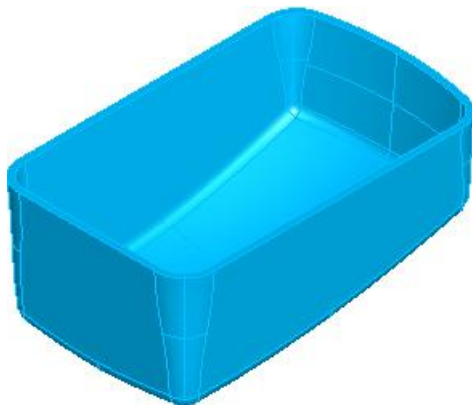

The tutorial is available only in metric units and introduces you to:

- Extrude design features.
- Hidden line graphics.
- Loft design features.
- Filleting solid models.
- Core/cavity separation of a solid model.
- Creating manufacturing features from solids.



---

## Getting started

1. Start FeatureCAM by double-clicking the FeatureCAM icon  on the desktop.
  2. If the **New Part Document** wizard is displayed, select the **New file** option, and click **Next**. Select **Milling Setup**, **Millimeter**, **None**, and click **Finish**.
  3. If the **New Part Document** wizard is not displayed, select **File > New** from the menu. Select **Milling Setup**, **Millimeter**, **None**, and click **OK**.
  4. Select **Toolbars** from the **View** menu.
  5. In the **Customize Toolbars** dialog, select the **Steps**, **Display Mode** and **Solid** check boxes on the **Toolbars** tab, and click **OK**.
- This opens the toolbars you need for this tutorial.

---

## Creating the initial solid

1. Select the **Curves**  step from the **Steps** panel.
2. In the **Curves Creation** dialog, select the **Curve Wizard**  button.
3. In the **Curve** wizard, select **Other methods** as the construction method, **Rectangle** as the constructor, and click **Next**.

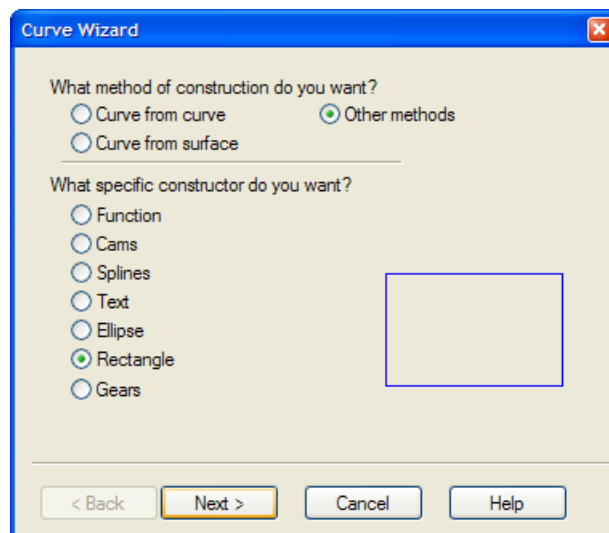

- On the **Rectangle** page, select the **Use corner, width, and height** option, and enter **0.0** and **0.0** for the **X** and **Y** Corner coordinates.
- Set **Width** to **100** and **Height** to **65**, select the **Create as arcs and lines** option, and click **Finish**.

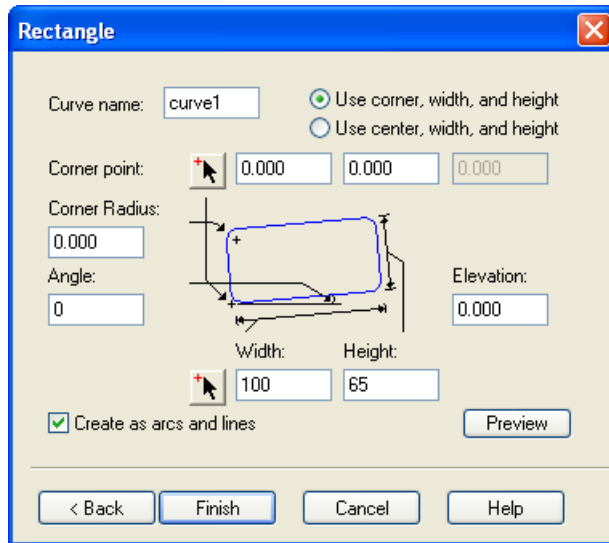

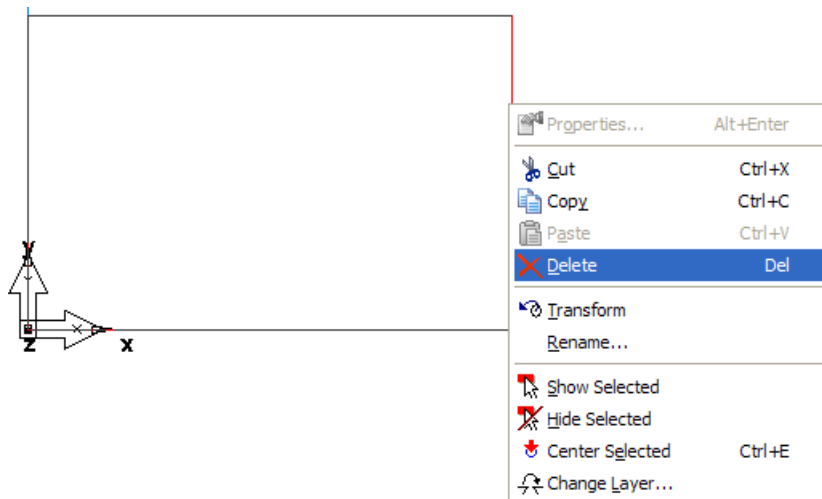

- In the **Graphics** window, right-click the right vertical line, and select the **Delete** option.



- Select **Options > Snapping Modes** from the menu.

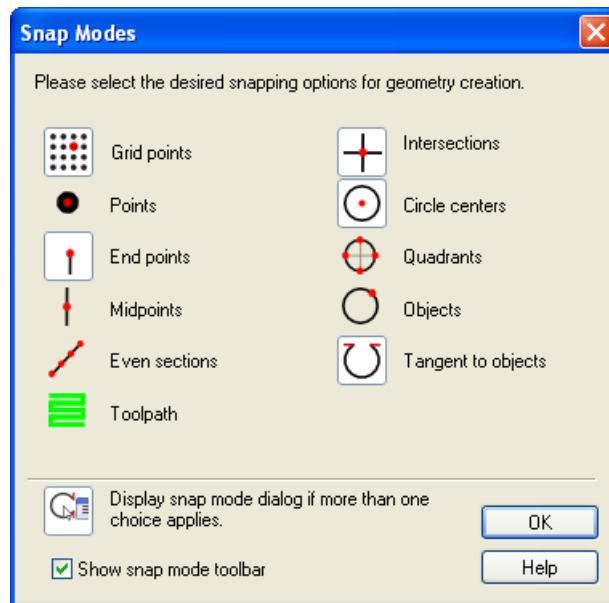

8. In the **Snap Modes** dialog, ensure the **End points** option is selected (selected buttons have pale grey borders around them), and click **OK**.

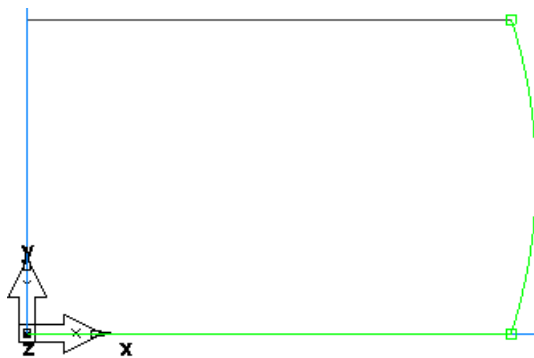

9. Create an arc.
  - a. Select **2Pts, Radius** from the **Arc**  menu on the **Geometry** toolbar.
  - b. In the **Feature/Geometry Edit** bar, enter **R = 105**.
  - c. Click the two open points in the **Graphics** window where the vertical line was.



10. Chain geometry into curves.

- a. Select the **Curves**  step from the **Steps** panel.
- b. In the **Curves Creation** dialog, select the **Closed Curve**  button, and click the arc you just created.
- c. Click the **Create** button on the **Feature/Geometry Edit** bar.

11. Click the **Solid Wizard**  button on the **Advanced** toolbar.
12. In the **Solid** wizard, select **Define a custom shape...**, and click **Next**.
13. Select **From Curves** as the method and **Extrude** as the constructor and click **Next**.

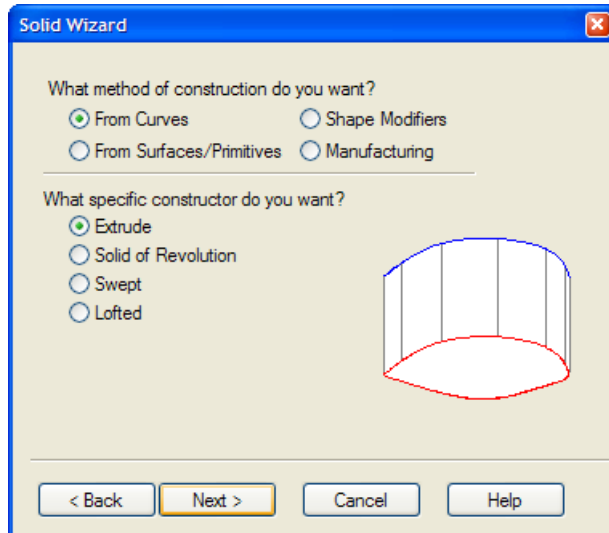

14. On the **Extruded Solid** page, enter **-50** as the **Vector Z** coordinate and **-5** as the **Draft Angle**, and click **Finish**.

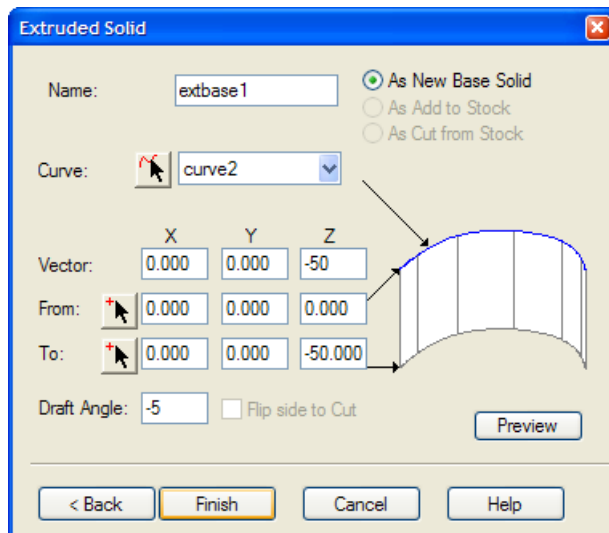

Your part in the **Graphics** window looks something like this:

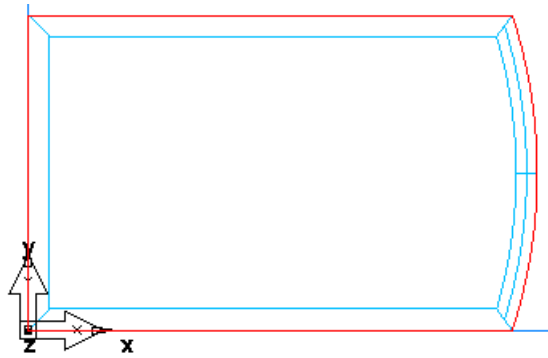

15. Open the **Part View** panel, and expand the **Solids** node to reveal **solid4**. This is the name of the solid we are creating. The number following the solid name may be different for you.
16. Expand **solid4** to reveal the features that make it up. There is only one feature called **extbase1**. A base feature is the initial feature for a solid.

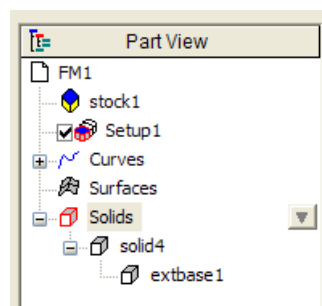

---

## Hidden line graphics

With solids there are additional graphics options available. By default, you are in line-drawing mode. With solids, hidden line graphics are available.

1. Click the **Isometric View**  button on the **Standard** toolbar.
2. Select the **Hide Stock** option from the **Hide**  menu on the **Advanced** toolbar.

The default view of your solid model is shown below. On this stage, it is impossible to tell if there is a top on the solid.

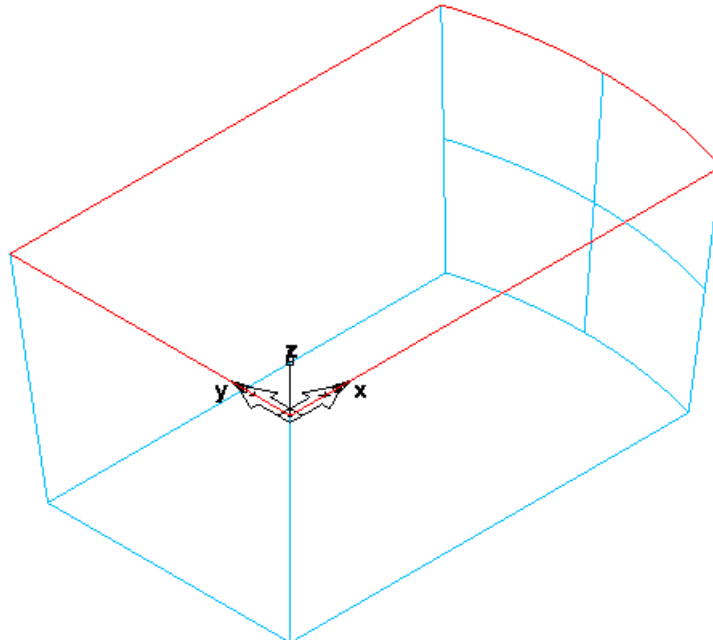

3. Click the **Hidden Line**  button on the **Display Mode** toolbar. The view of your solid model changes, making it clear that there is a top on the solid.

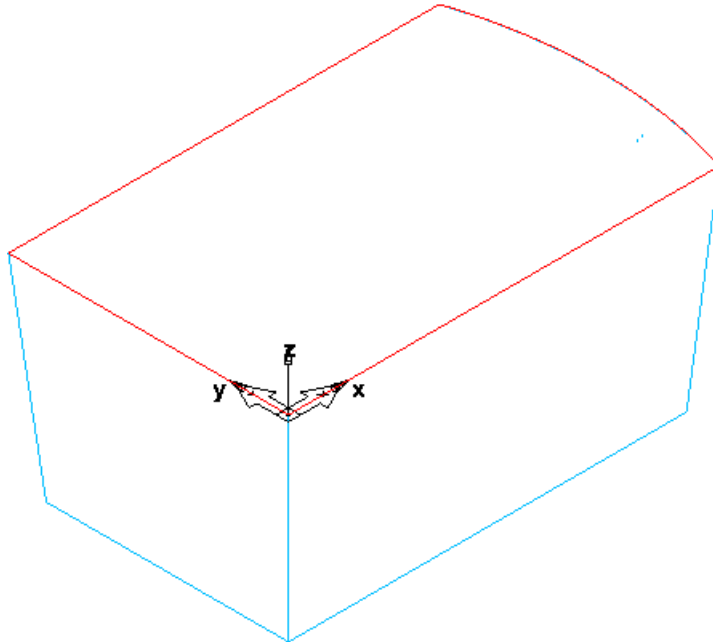

While hidden-line mode provides nice quality graphics, it is considerably slower than simple line drawings, and sometimes hides portions of the model you need to pick.

4. To return back to line drawing mode, click the **Hidden Line**  button again.



*Hidden line graphics are only available for solids.*

## Creating the curved lower surface

1. From the **Show**  menu on the **Advanced** toolbar, select **Show Stock**.
2. In the **Graphics** window, double-click the stock to open the **Properties** dialog, and click the **Resize** button on the **Dimensions** tab.

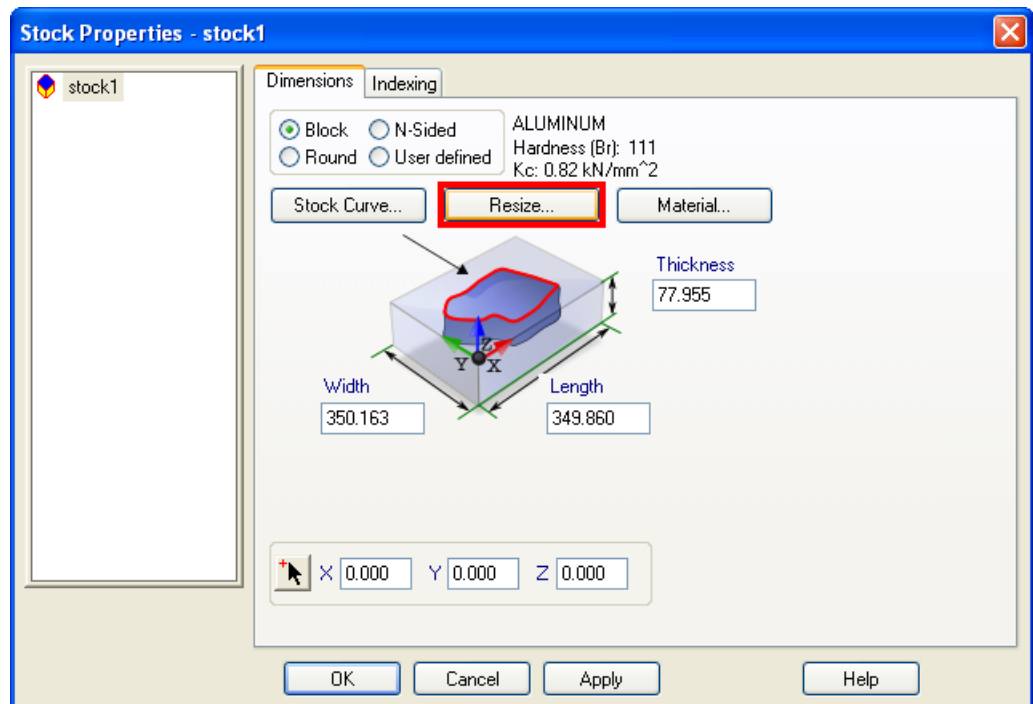

3. In the **Stock** wizard (**Stock Dimensions** page), select **Compute stock size from the size of the part**, and click **Next**.
4. On the **Resize** page, select **Move Stock**, and click **Finish**.  
The view automatically changes to top view.



5. Select the **Front** option from the **Principal View**  menu on the **Standard** toolbar.

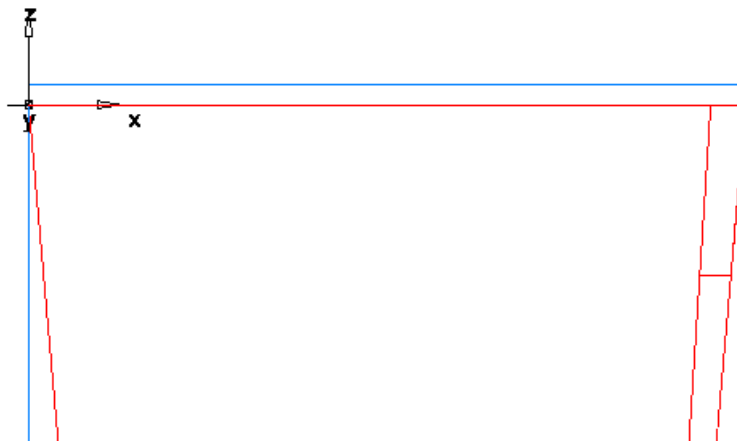

6. Create two arcs.
- Select **2Pts, Radius** from the **Arc**  menu on the **Geometry** toolbar.
  - In the **Feature/Geometry Edit** bar, enter **R = 400**.
  - Set **X1** to **120**, **Y1** to **0** and **Z1** to **-20**; set **X2** to **-10**, **Y2** to **0** and **Z2** to **-40**, and click the **Create** button.

The part in the **Graphics** window looks something like this:

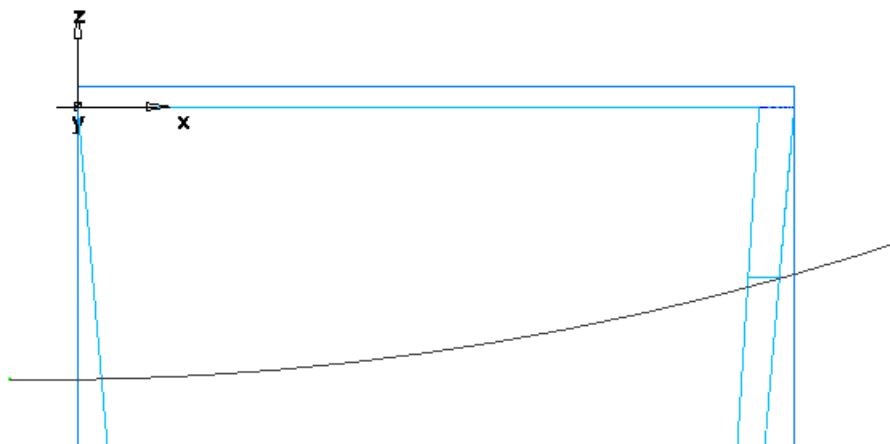

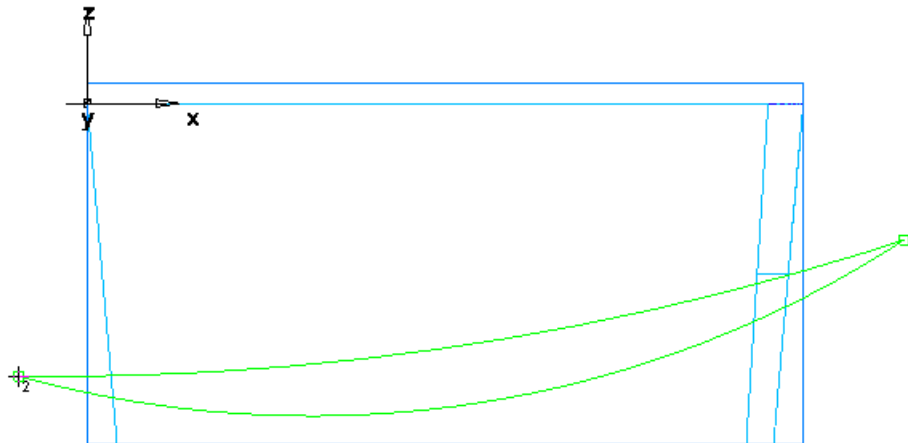

- Entering **R = 160** for the second arc.

- e. Click the right endpoint of the first arc, and then click the left endpoint of the arc. The new arc should curve down.



*If your arc curves up instead of down, select the arc, and click the **Options** button on the **Feature/Geometry Edit** bar.*

*If the cursor is still in the arc create mode, click the **Select**  button on the **Standard** toolbar. Now you are able to click and select the arc.*

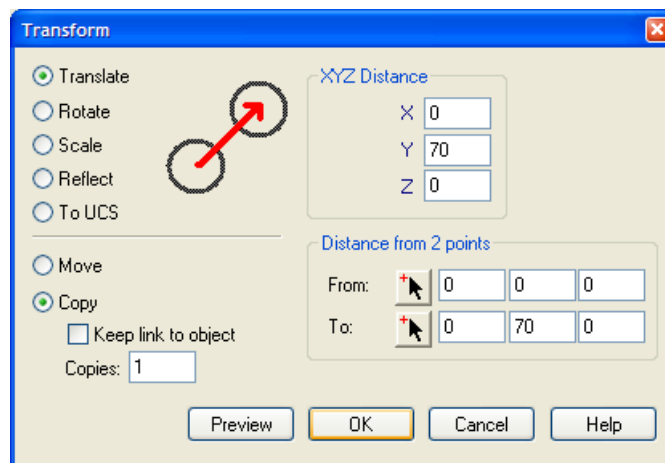

7. Select the first (top) arc, and click the **Transform**  button on the **Standard** toolbar.
8. In the **Transform** dialog, select the **Translate** and **Copy** options, enter **70** in the **Y** coordinate of **XYZ Distance**, and click **OK**.

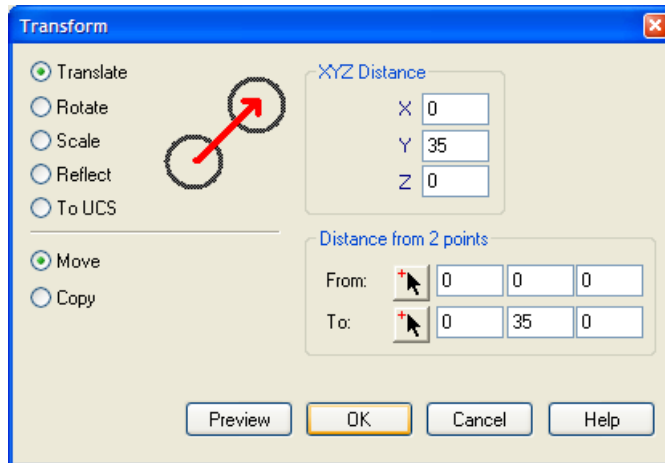

9. Select the second (bottom) arc, and click the **Transform**  button.

10. In the **Transform** dialog, select the **Translate** and the **Move** options, and enter **35** in the **Y** coordinate of **XYZ Distance**, and click **OK**.



11. Select the **Isometric** option from the **Principal View**  menu on the **Standard** toolbar.
12. Click the **Solid Wizard**  button on the **Advanced** toolbar.
13. In the **Solid** wizard, select **From Curves** as the construction method and **Lofted** as the constructor, and click **Next**.



14. Since we want to use this design feature to remove material, on the **Lofting** page select the **As Cut** option, and click the **Pick Curve**  button, and select the arcs in the order shown in the figure.

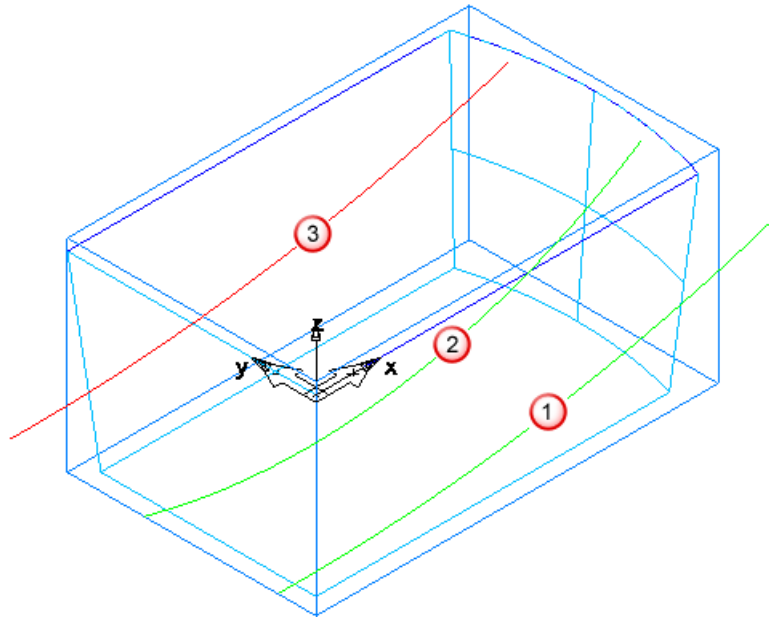

15. If the selected arcs appear out of order in the curve list, use the arrows to move the arcs up or down.

16. Click **Finish**.

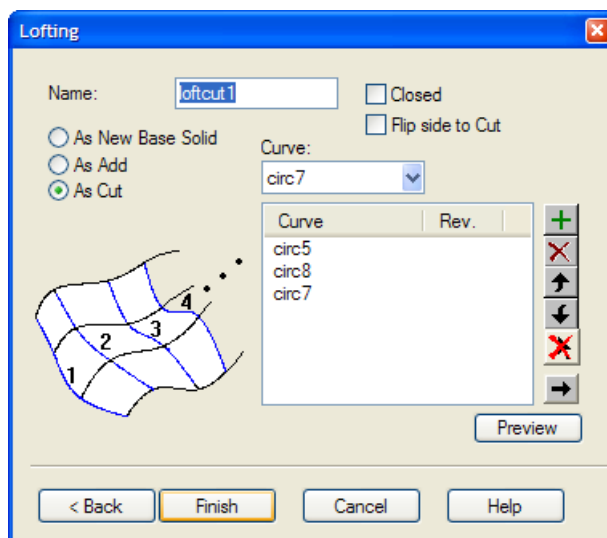



The curves are used to create a lofted surface and then the surface is used to cut the solid.

An additional design feature, called **loftcut1** is now listed in the **Part View** panel.

# Creating constant and variable radius fillets

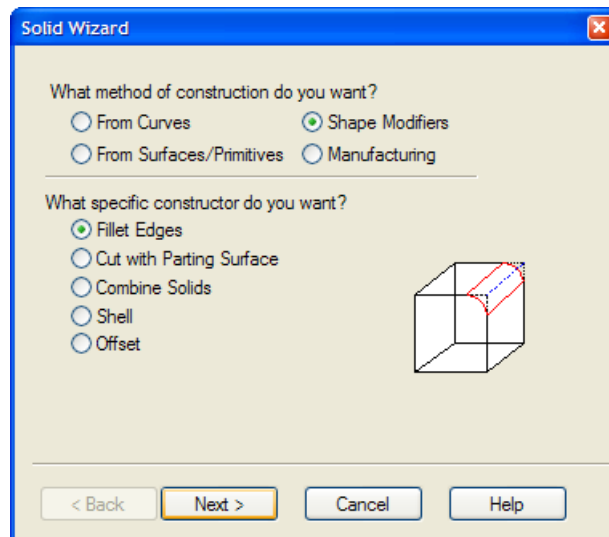
1. Click the **Solid Wizard**  button on the **Advanced** toolbar.
2. In the **Solid** wizard, select **Shape Modifiers** as the construction method and **Fillet Edges** as the constructor, and click **Next**.



3. On the **Edge Fillet** page, enter **5** as the **Radius**, click the **Pick Curve**  button, and select the bottom edges **1-4** as shown in the figure.

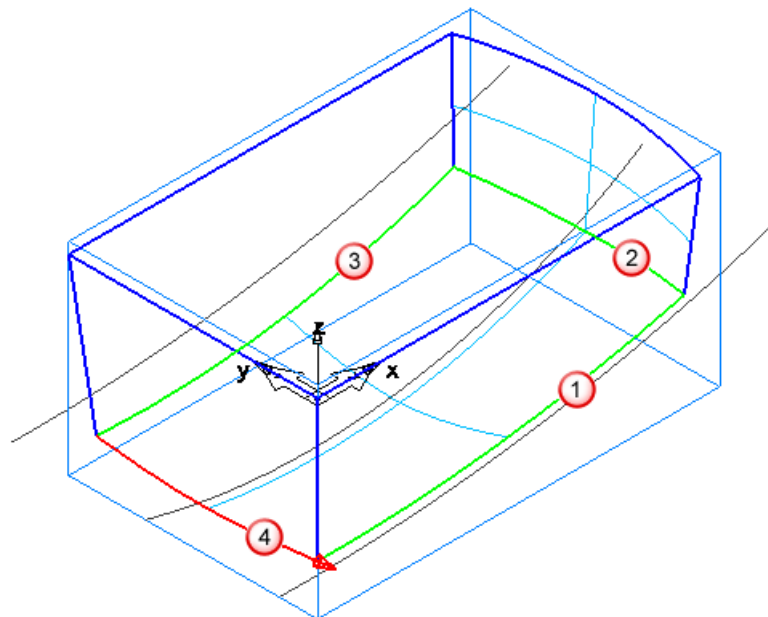

4. Return to the wizard, click the **Variable** option, and enter **5** as the **Begin radius** and **10** as the **End radius**.

- Return to the **Graphics** window, and select the vertical edges **5-8** as shown in the figure.

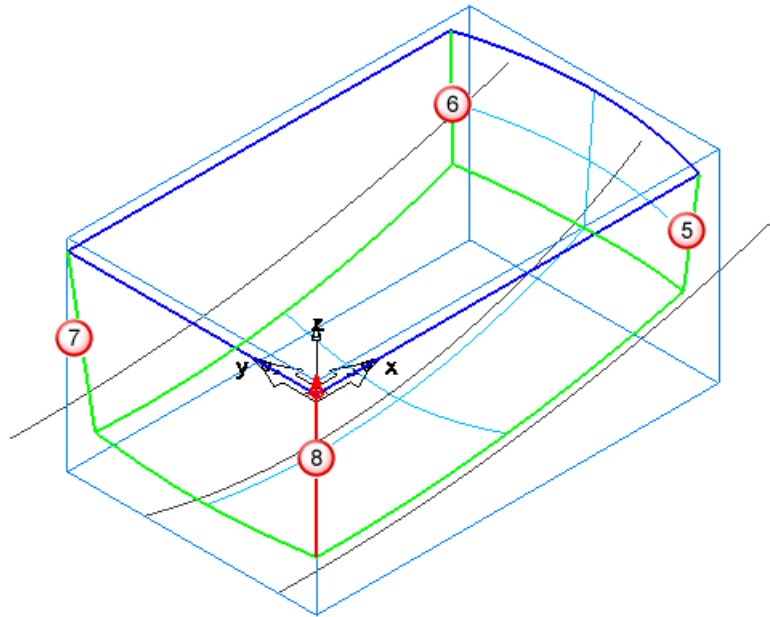

This creates a variable radius fillet on these edges. As you click each edge an arrow is displayed to show the edge direction. The first radius is applied to the tail of the arrow and the second to the head of the arrow.

- Click **Finish**.

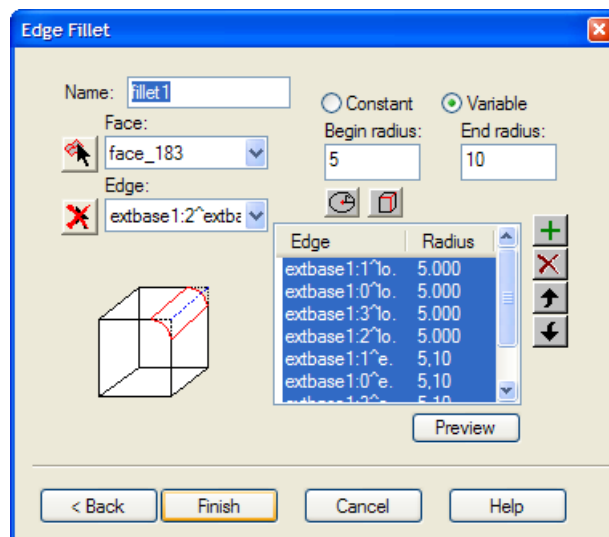

The solid part looks something like this:

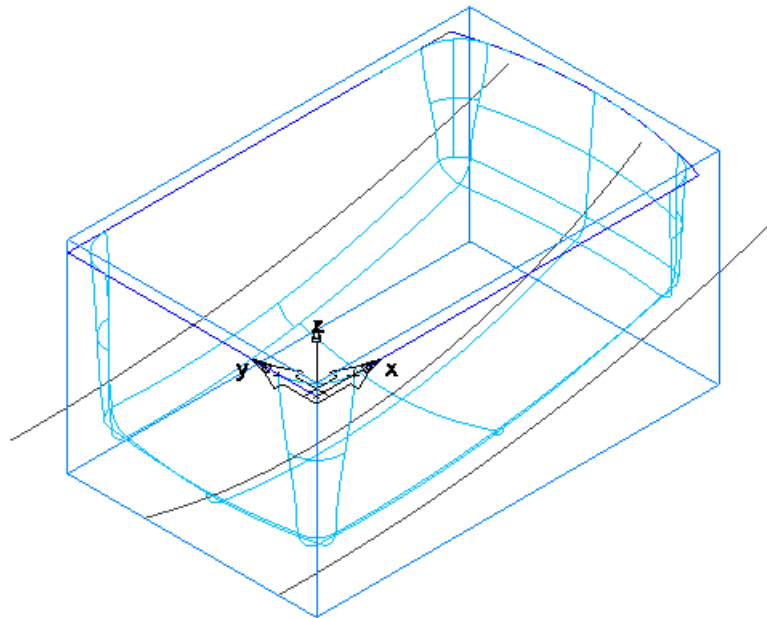

The selected edges are filleted and the surrounding surfaces have been trimmed. The corners where the fillets meet are automatically filleted.

An additional design feature, called **fillet1** is now listed in the **Part View** panel.

---

## Adding thickness

1. Click the **Solid Wizard**  button on the **Advanced** toolbar.
2. In the **Solid** wizard, select **Shape Modifiers** as the construction method and **Shell** as the constructor, and click **Next**.

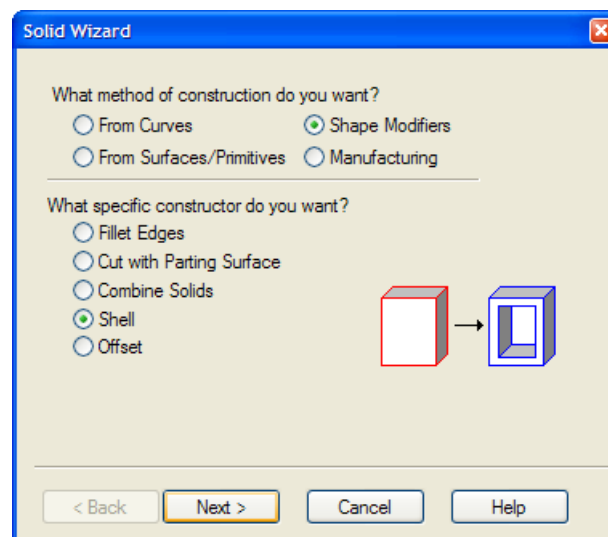

3. On the **Shell** page, enter an **Offset distance** of **-2**, and click the **Pick Surface**  button.
4. Click the top surface as shown in the figure.

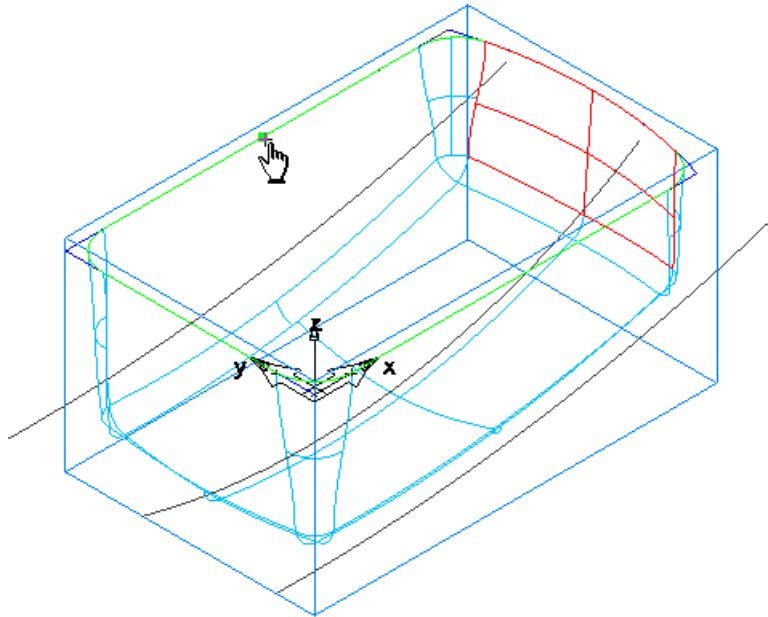

This surface will not be offset. If the **Select** dialog opens, select the name that corresponds to the top surface. The surfaces are highlighted in the **Graphics** window as you select the names.

5. Click **Finish**.

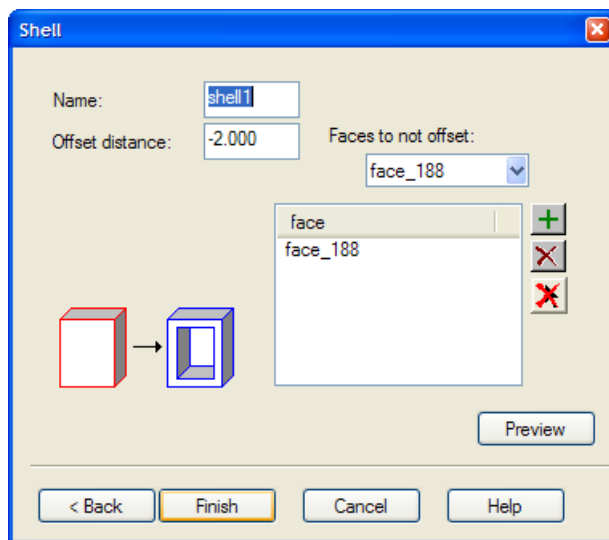

All faces of the solid except the top surface are now offset by 2mm to provide thickness to the part. An additional design feature, called **shell1** is now listed in the **Part View** panel.

6. Select the **Hide All Geometry** option from the **Hide**  menu on the **Advanced** toolbar.



7. Click the **Hidden Line**  button on the **Display Mode** toolbar to have a better view of the solid.

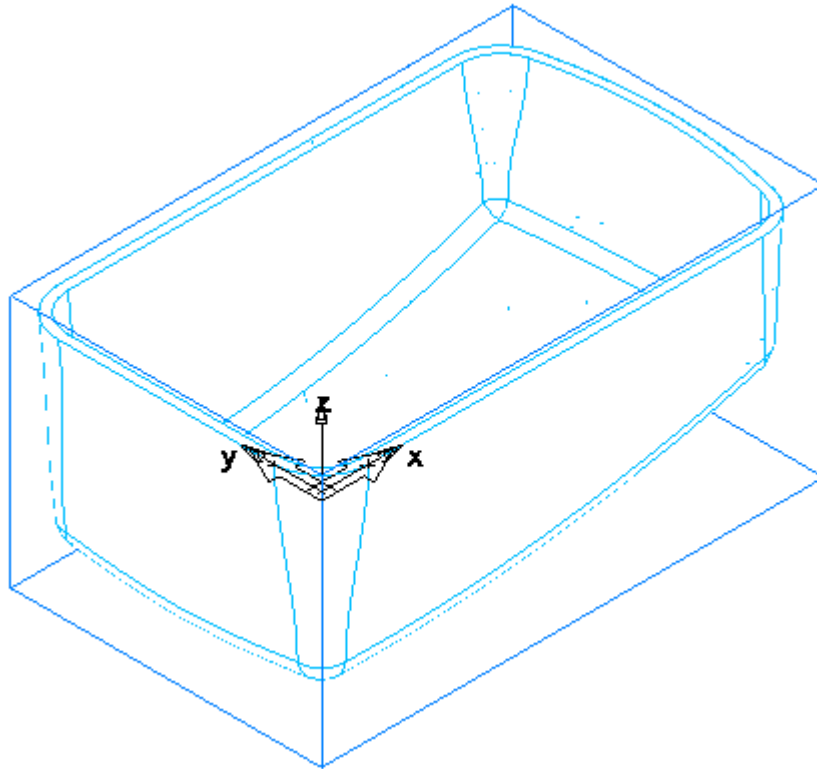

At this point, the solid model of the speaker is complete.

---

## Creating a mold cavity

Now the challenge is to create a mold from the solid model. For parts that can be created with two mold halves, FeatureCAM's core/cavity feature is a useful tool.

1. Click the **Solid Wizard**  button on the **Advanced** toolbar.

2. In the **Solid** wizard, select **Manufacturing** as the construction method and **Select Core/Cavity** as the constructor, and click **Next**.

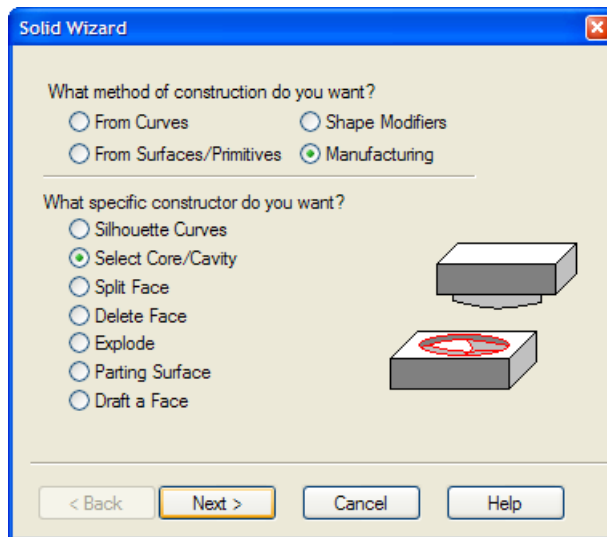

3. On the **Select Core/Cavity** page, select the **Bottom** option.
4. Select the **Make solid from result** option. This creates a new solid that contains the cavity faces.
5. Click **Finish**.

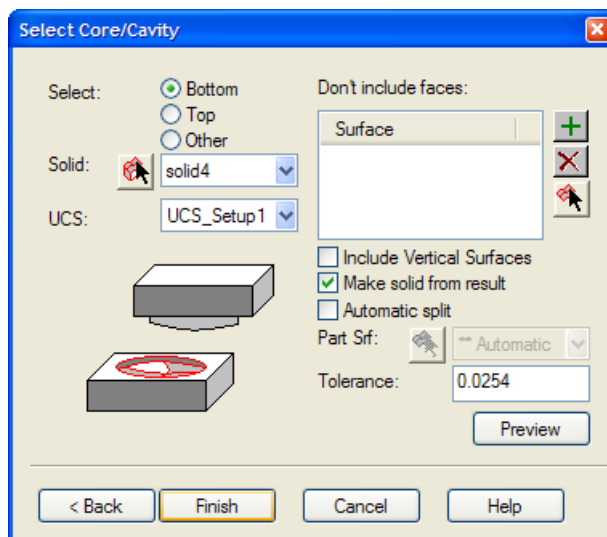

A new solid, called **sheet1**, is added to the **Solids** node on the **Part View** panel.

6. Right-click the **solid4** on the **Part View** panel, and select the **Hide Selected** option. You can now see the cavity.

You have completed this tutorial.

# Introduction to WIRE



*You must have WIRE to perform this tutorial.*

In this tutorial, you will learn the basics of creating wire EDM toolpaths using WIRE. This tutorial is only available in inch units.

Specifically, you will learn how to:



- Set up your material and wire thickness.
- Create wire EDM features.
- Specify a wire EDM cutting strategy.
- Simulate wire EDM toolpaths.

---

## Getting started

1. Start FeatureCAM by double-clicking the FeatureCAM icon  on the desktop.
2. If the **New Part Document** wizard is displayed, select the **New file** option, and click **Next**. Select **Wire EDM Setup, Inch, Wizard**, and click **Finish**.
3. If the **New Part Document** wizard is not displayed, select **File > New** from the menu. Select **Wire EDM Setup, Inch, Wizard**, and click **OK**.
4. In the **Stock** wizard (**Dimensions** page), set the stock **Width** and **Length** to **4.0** and the **thickness** to **0.5**.
5. Click the triangle next to the **Finish** button, and select the **Finish** option.

# Creating the profile

1. Select the **Curves**  step from the **Steps** panel.
2. In the **Curves Creation** dialog, select the **Curve Wizard**  button.
3. In the **Curve** wizard, select **Other methods** as the construction method and **Rectangle** as the constructor, and click **Next**.

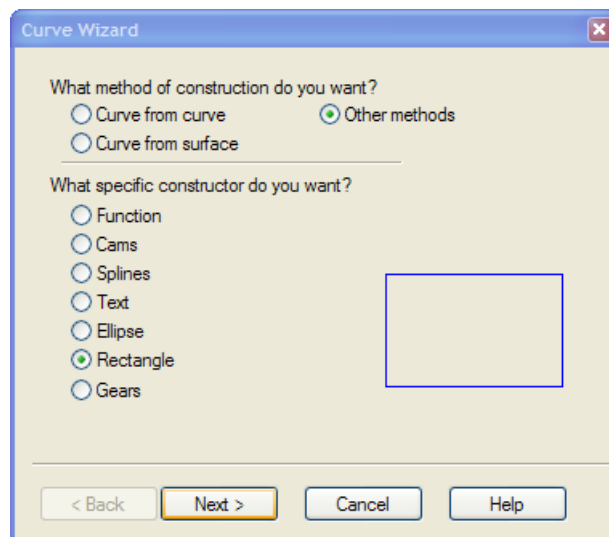

4. On the **Rectangle** page, select **Use corner, width, and height**.
5. Set the corner point to **1, 1, 0**.
6. Set the corner radius to **0.5** and set the **Width** and **Height** to **2.0**.
7. Click **Finish**.

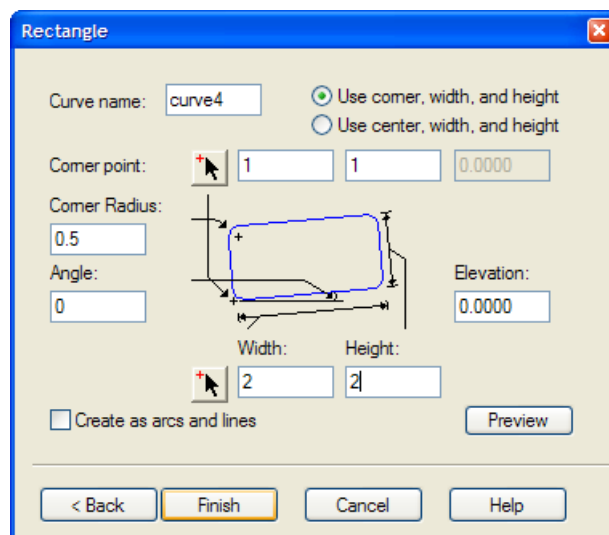

Your part in the **Graphics** window should look something like this:

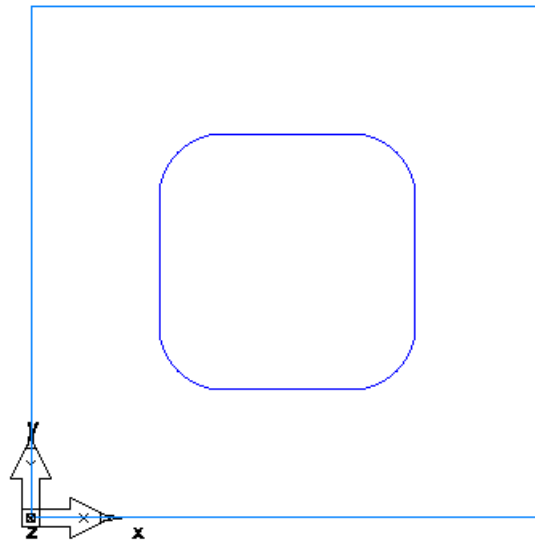

# Creating a wire EDM feature

1. Select the **Features**  step from the **Steps** panel.
2. In the **New Feature** wizard, select the **Die** option in the **2 Axis** frame, and click **Next**.

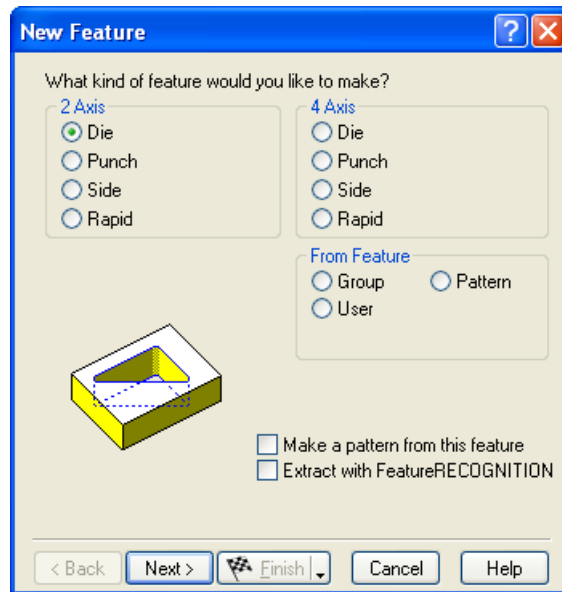

3. On the **Curves** page, click the **Pick Curve**  button, and select the curve you just created.

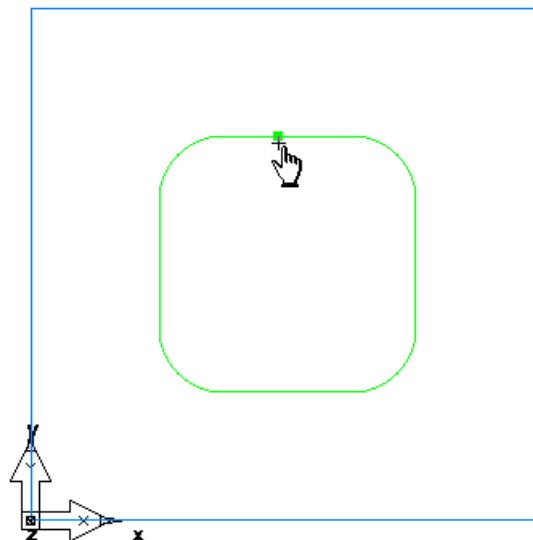

4. Click **Next** until you get to the **Dimensions** page.
5. Enter **0.5** as the **Thickness** and click **Next** twice to get to the **Strategies** page.



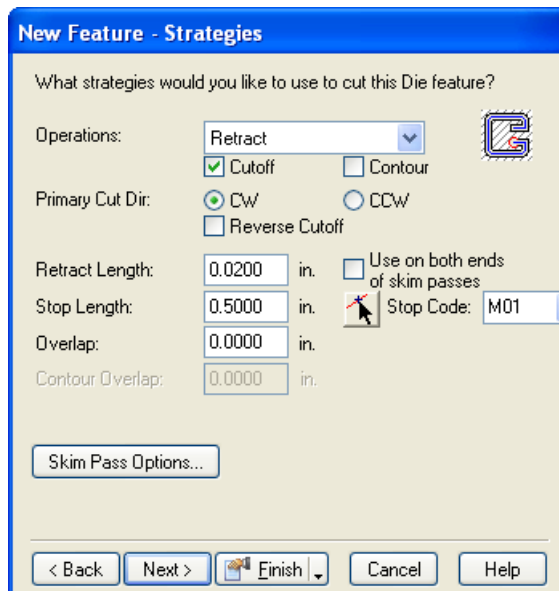

6. Select **Retract** in the **Operations** field, and select the **Cutoff** and **Contour** options.



7. Click the triangle next to the **Finish** button, and select the **Finish** option.

---

## Simulating a wire EDM toolpath

1. Select the **Toolpaths**  step from the **Steps** panel. The **Simulation** toolbar is displayed.
2. Click the **2D Simulation**  button on the **Simulation** toolbar.
3. Move the **Sim Speed**  slider to the middle so that the simulation is slowed down.
4. Select the **Play to Next Operation** option from the **Simulation Next**  menu.

You'll notice that the Retract operation makes two passes. If you need to slow down the simulation, drag the **Sim Speed**  slider to the left.

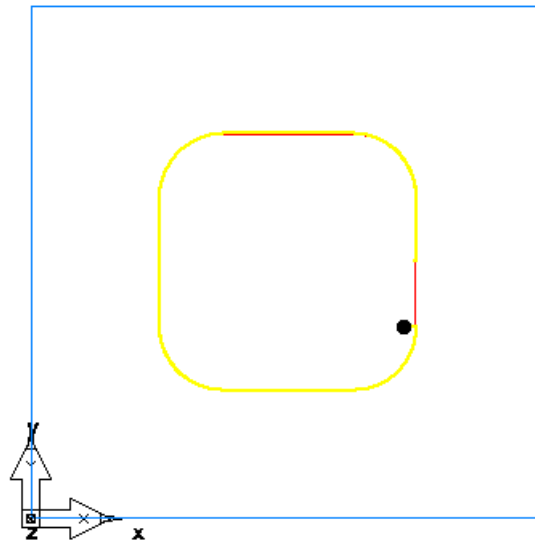

5. Click the **Play to Next Operation**  button again. The Cutoff operation now takes two passes. Slow down the simulation if you need to.

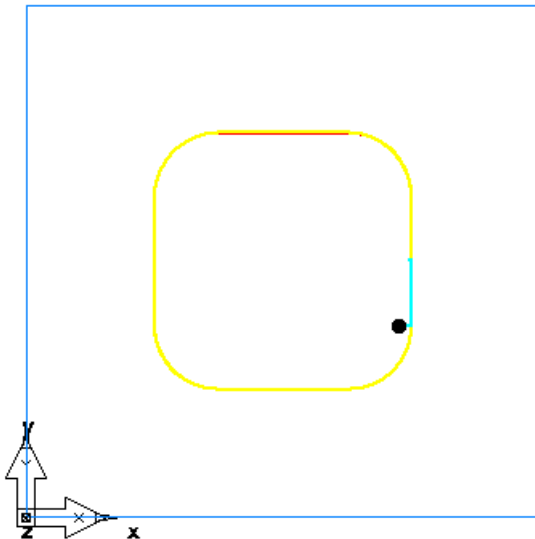



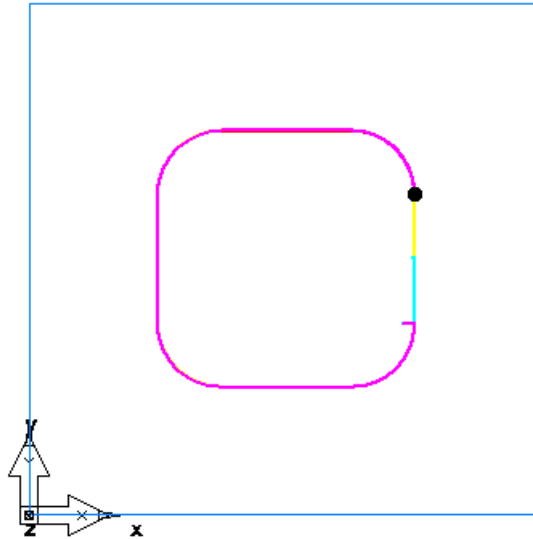

- Click the **Play to Next Operation**  button once more. The final Contour operation is now simulated.



- Click **Eject** .

---

## Generating NC code

- Select the **NC Code**  step from the **Steps** panel.
- Click the **Display the NC Code**  button in the **NC Code** dialog to generate the NC code.



---

## Adding a taper angle

- Open the **Part View** panel, select the **die1** feature from the **Setup1** node, and click the **Properties**  button on the **Feature/Geometry Edit** toolbar.

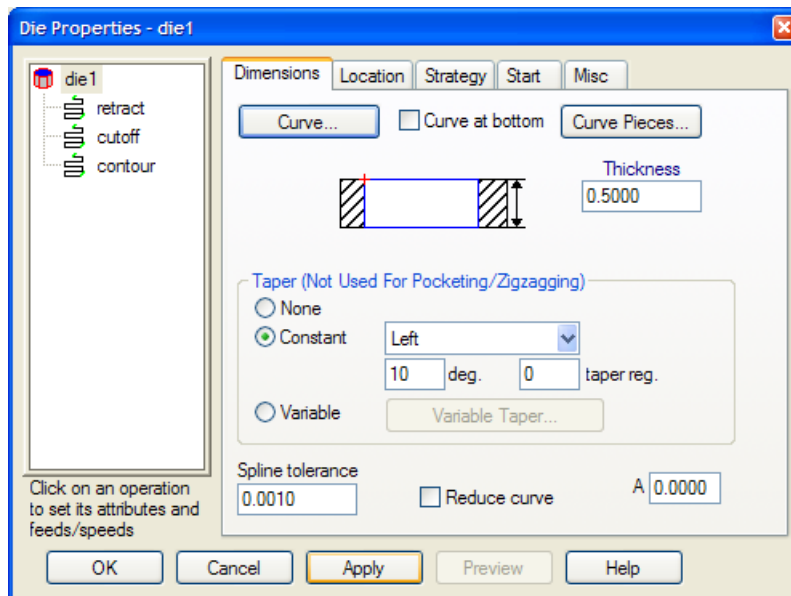
- In the **Properties** dialog for **die1**, select the **Constant** option, choose **Left** as the taper type, enter **10** as the taper angle in the **Deg.** field, and click **Apply**.



- Select the **Hide Stock** option from the **Hide**  menu on the **Advanced** toolbar, and click the **Isometric View**  button on the **Standard** toolbar to get a 3-dimensional view of the part.

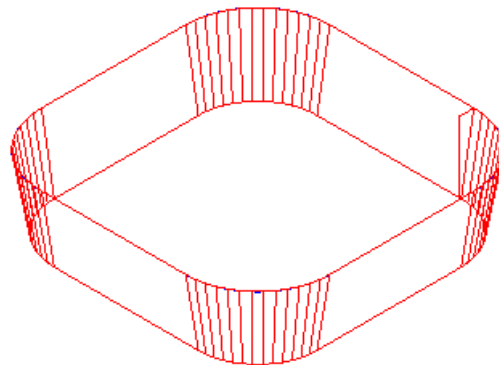

- Return back to the **Properties** dialog, set the taper type to **Right**, and click **Apply**. View the new shape in Isometric view.

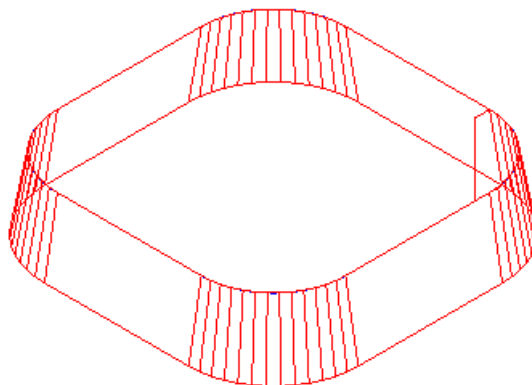





12. Open the **Part View** panel, right-click the **die1** feature, and select the **Hide Selected** option. Now the feature will not be displayed on the screen.

---

## Creating the second profile

1. Select the **Top** option from the **Principal View**  menu on the **Standard** toolbar.
2. Select the **Curves**  step from the **Steps** panel.
3. In the **Curves Creation** dialog, select the **Curve Wizard**  button.
4. In the **Curve** wizard, select **Other Methods** as the construction method and **Rectangle** as the constructor, and click **Next**.

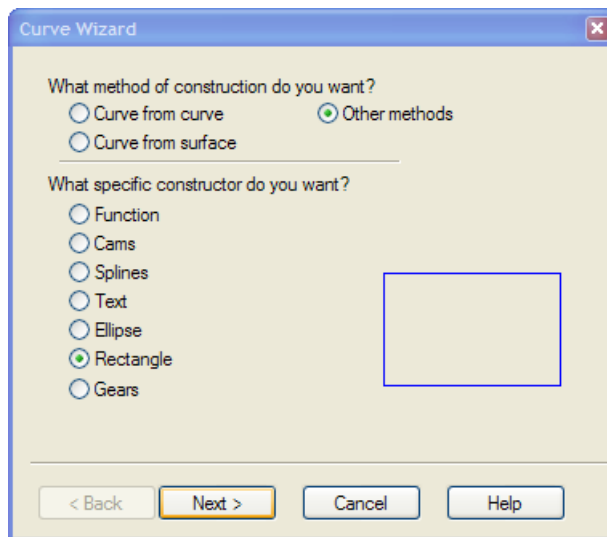

5. On the **Rectangle** page, select **Use corner, width and height**.
6. Set the corner point to **0.5, 0.5, 0.0**.

7. Set the **Width** and **Height** to 3.0, and click **Finish**.

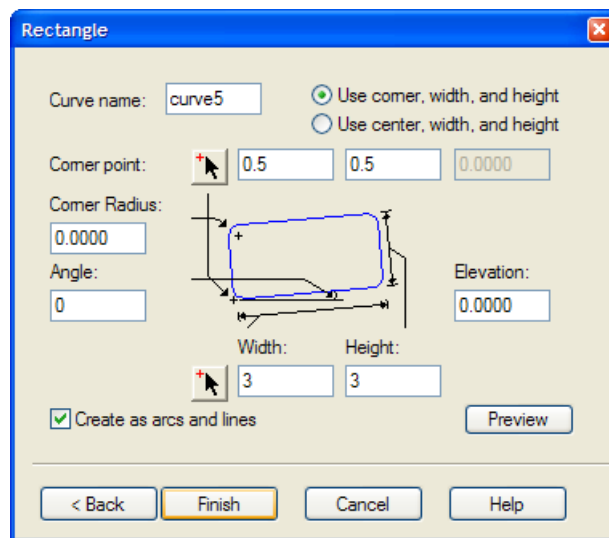

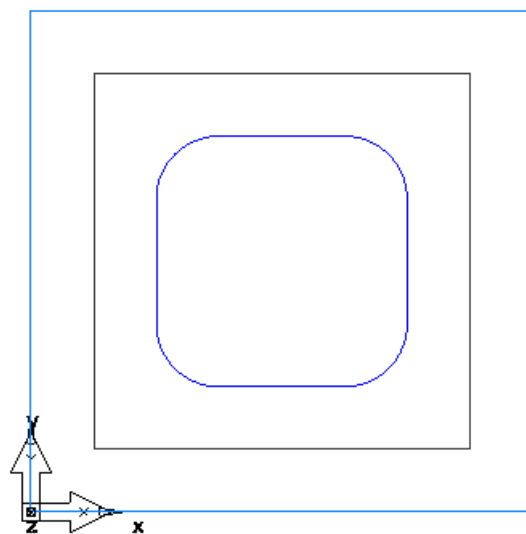

Your part in the **Graphics** window should look something like this:

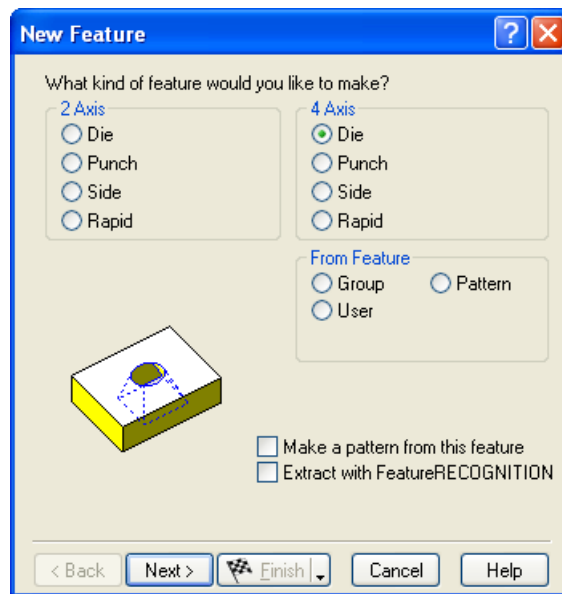

# Creating a 4-axis wire EDM feature

1. Select the **Features**  step from the **Steps** panel.
2. In the **New Feature** wizard, select the **Die** option in the **4 Axis** frame, and click **Next**.



3. On the **Upper Curve** page, click the **Pick Curve**  button and select the curve that you just created.

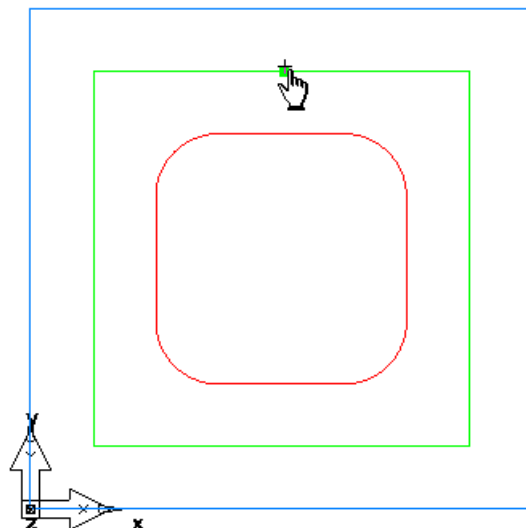

4. Click **Next**.

5. On the **Lower Curve** page, click the **Pick curve**  button and select the smaller curve that you created first.

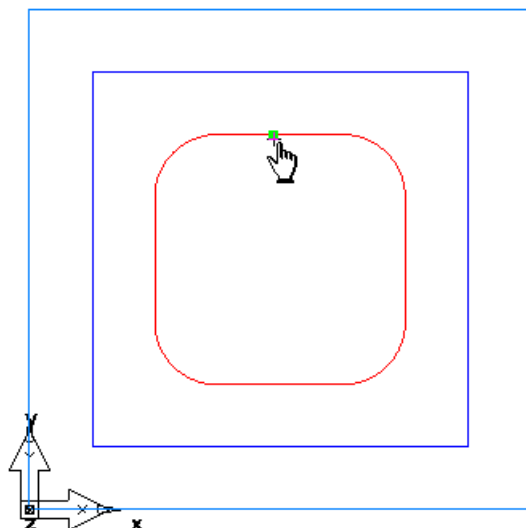

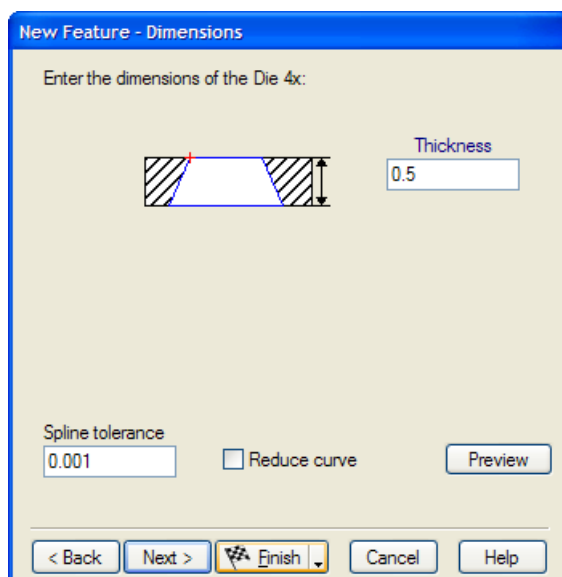

6. Keep clicking **Next** until you get to the **Dimensions** page.
7. Enter **0.50** as the **Thickness**, click the triangle next to the **Finish** button, and select the **Finish** option.

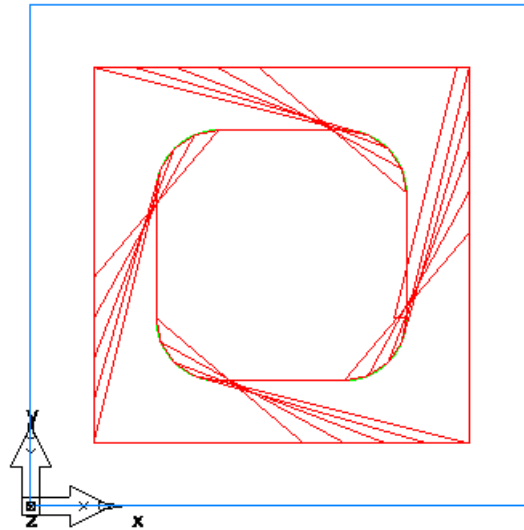

The feature is twisted because the start points were not set.



## Modifying the start point

1. Open the **Part View** panel, select the **die4x1** feature from the **Setup1** node, and click the **Properties**  button on the **Feature/Geometry Edit** bar.
2. In the **Properties** dialog for **die4x1**, click the **Start** tab.
3. Click the **Pick Location**  button for the **Upper Curve Start/End Point**.
4. In the **Graphics** window, click a point in the center of the stock, and then click on the bottom horizontal line of the outer curve. You should notice a green line between the point and the edge of the curve.

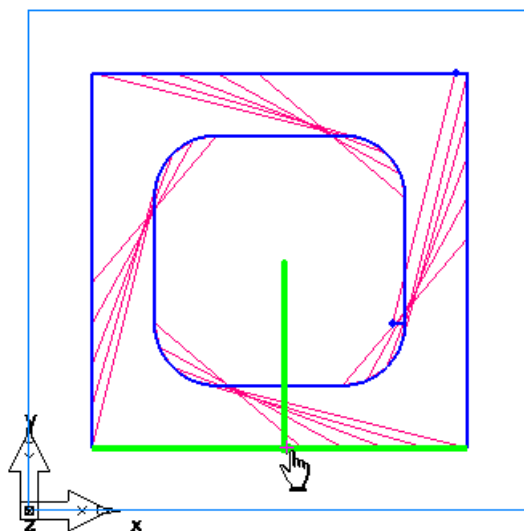



5. Click the **Pick location**  button this time for the **Lower Curve Start/End Point**.
6. Click in the center of the stock and click the bottom horizontal line of the inner curve.

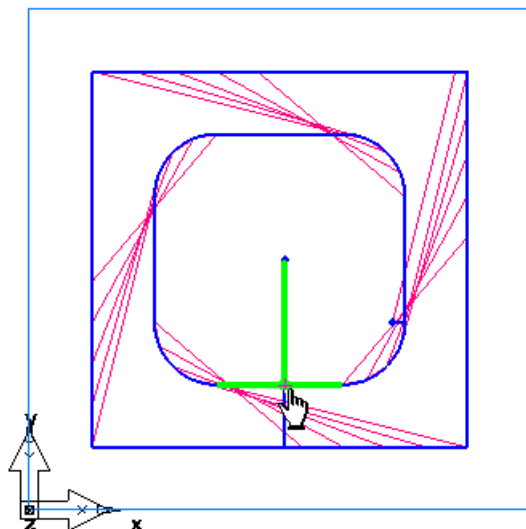

7. Click **OK**. The feature now should no longer be twisted.

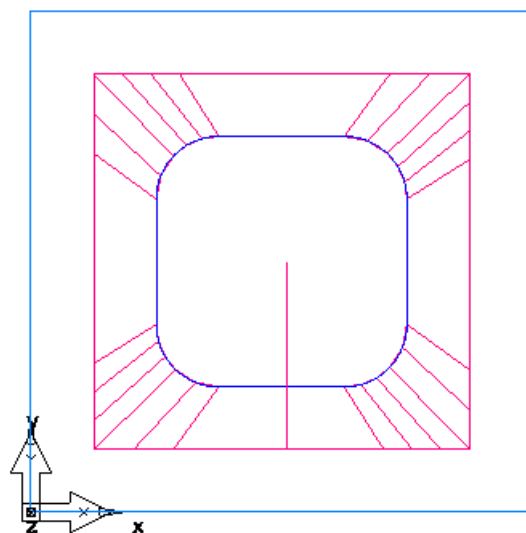

---

## Matching the curves

1. Open the **Part View** panel, select the **die4x1** feature from the **Setup1** node, and click the **Properties**  button on the **Feature/Geometry Edit** bar.

2. In the **Properties** dialog for **die4x1**, click the **Dimensions** tab and click the **Match Curves** button.

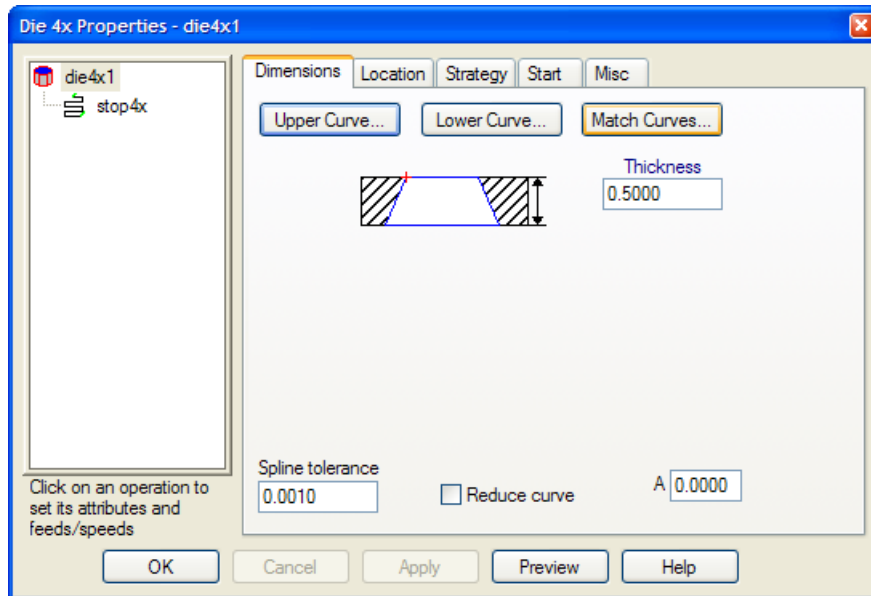

3. In the **Match Curves** dialog, click the **Pick Lower Curve Point** button.
4. In the **Graphics** window, select the top right point on the lower curve, and then select the right corner point on the upper curve. You should see a green line between the two points.

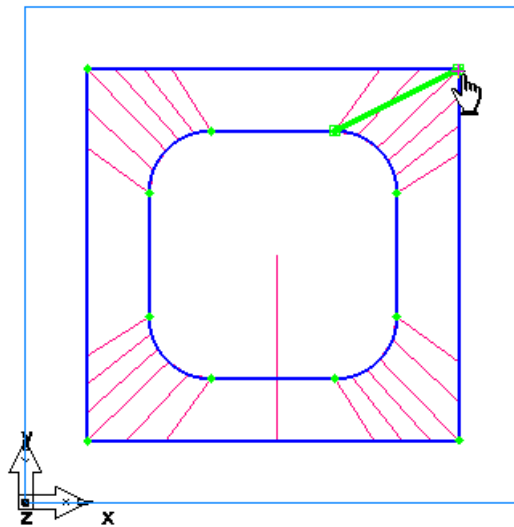

5. Hold down the **Shift** key and select the upper-right point on the lower curve, and then select again the right corner point at location.

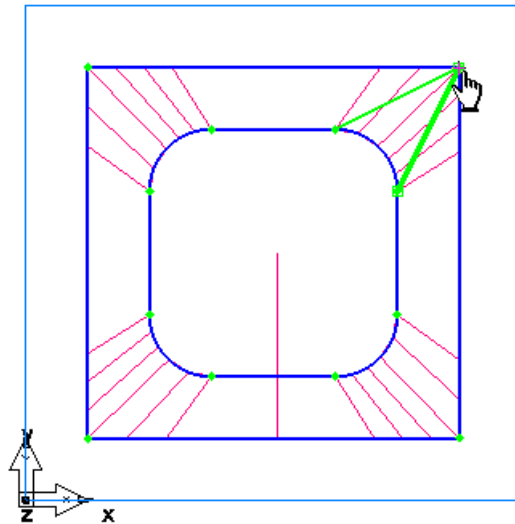

Now you have matched both points on the lower curve to the single point on the upper curve.

6. Click **Apply**, and then click **OK** to close the **Match Curves** dialog.
7. Click **OK** in the **Properties** dialog.

The part in the **Graphics** window looks something like this:

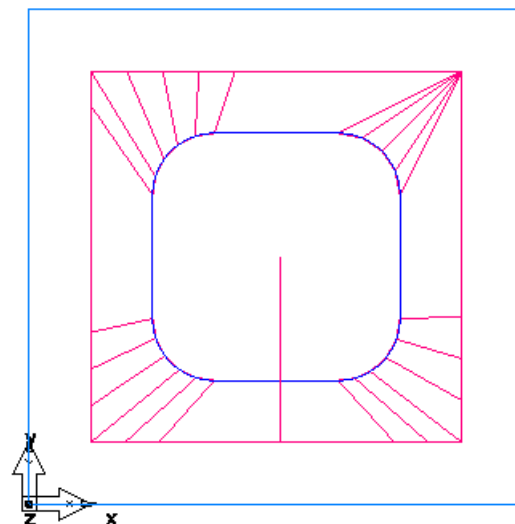



---

## Simulating the part

1. Open the **Part View** panel and deselect the check box next to the **die1** feature to exclude it from the simulation.
2. Click the **Isometric** option from the **Principal View**  menu on the **Standard** toolbar.

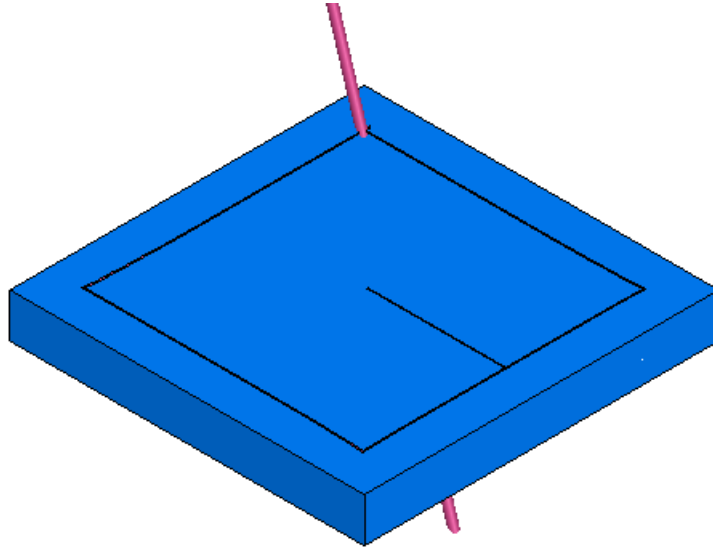
3. Select the **Toolpaths**  step from the **Steps** panel.
4. Click the **3D Simulation**  button, and then click the **Play**  button.



5. Click the **Select**  button on the **Standard** toolbar.
6. Click the stock in the region inside of the curve. FeatureCAM deletes that part of the stock.

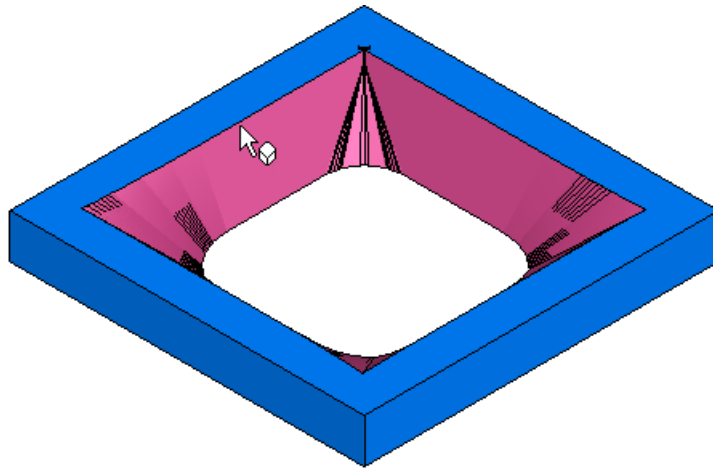

7. Click **Eject** .

You have completed this tutorial.



# Index

## 2

- 2.5D Milling • 56
- 2D Simulation button • 22
- 2D turned profiles • 21

## 3

- 3D milling • 124
- 3D rapidcut simulation • 22
- 3D simulation • 22

## A

- Advanced toolbar • 19
- Arc menu • 22
- Assistance bar • 15, 50
- Automatic Feature Recognition • 114

## C

- Chain menu • 22
- Circle menu • 22
- Context-sensitive help • 18, 52, 54
- Curves
  - Curve from Curve menu • 20
  - Curve from Surface menu • 20
  - Curve menu • 20
  - Curve wizard • 19
  - Curves and Surfaces toolbar • 20

- Curves step • 34
- Features from curves (tutorial) • 71
- Customize Manufacturing step • 39

## D

- Databases
  - Materials database • 43
  - Tools database • 42
- Delete • 18, 30, 52
- Details tab • 49
- Dimension menu • 22
- Display Mode toolbar • 21
  - 2D turned profiles • 21
  - Draft hidden line mode • 21
  - Hidden line mode • 21, 151
  - Shade Selected button • 21
  - Show normals • 21
  - Unshade all • 21
  - Unshade selected • 21
  - Unshow normals • 21
- Draft hidden line mode • 21

## E

- Edit menu • 22
- Eject button • 22
- Engraving • 104

## F

- Fast forward to end of simulation • 22
- Feature/Geometry Edit bar • 15, 50
- FeatureMILL3D • 124
- Features • 19
  - Feature/Geometry Edit bar • 15, 50
  - Features from curves (tutorial) • 71
  - Features step • 35
- FeatureTURN/MILL • 97
- FeatureWIRE • 3, 164
- Fillet menu • 22

## G

- Geometry
  - Feature/Geometry Edit bar • 15, 50
  - Geometry step • 33
  - Geometry toolbar • 19, 22
    - Arc menu • 22
    - Chain menu • 22
    - Circle menu • 22
    - Edit menu • 22
    - Fillet menu • 22
    - Line menu • 22
    - Point • 22
  - Importing geometry • 137
- Graphics window • 15, 26

## H

- Help • 18, 54
  - Context-sensitive help • 18, 52, 54
- Hidden line mode • 21, 151
- Hide menu • 19

## I

- Importing geometry • 137
- INITDB • 108
- Interface • 15
  - Graphics window • 15, 26
  - Title bar • 15, 16
  - Toolbars • 15, 17

- Part View panel • 15, 45
- Steps panel • 15, 31

## K

- keyboard shortcuts • 16, 52

## L

- Line menu • 22

## M

- Machine simulation • 22
- Machining preferences • 39, 40
- Materials database • 43
- Menus • 15, 16
  - Circle menu • 22
  - Dimension menu • 22
  - Fillet menu • 22
  - Hide menu • 19
  - Line menu • 22
  - Menu bar • 15, 16
  - Principle View menu • 18
  - Show menu • 19
  - View menu • 18
- Metric • 108
- More Simulation toolbar • 25
- Mouse
  - Mouse buttons • 26
  - Mouse cursor • 26
- Mouse cursor • 26

## N

- NC code • 39, 50
  - NC Code step • 39
  - NC Code tab • 50
- New Feature • 19
- New file • 9, 18

## O

- Opening files • 18

Operation list • 49  
Options • 18

## P

Part View panel • 15, 45  
Pause simulation • 22  
Play button • 22  
Point • 22  
Post options • 44  
Principle View menu • 18  
Printing • 51, 52

## R

Region of interest simulation • 22  
Results window • 15, 49

## S

Saving files • 14, 18, 52  
Selecting • 18, 28, 52  
Shading • 18, 21, 29  
    Draft hidden line mode • 21  
    Shade Selected button • 21  
    Unshade all • 21  
    Unshade selected • 21  
Show menu • 19  
Show normals • 21  
Simulation  
    More Simulation toolbar • 25  
    Region of interest simulation • 22  
    Simulation toolbar • 22  
        2D Simulation button • 22  
        3D rapidcut simulation • 22  
        3D simulation • 22  
        Eject button • 22  
        Fast forward to end of simulation  
        • 22  
        Machine simulation • 22  
        Pause simulation • 22  
        Play button • 22  
        Region of interest simulation •  
        22

    Simulation speed • 22  
    Single step simulation • 22  
    Stop simulation • 22, 52  
Single step simulation • 22  
Snap modes  
    Snap Mode toolbar • 20  
    Snap Modes dialog • 19  
Snapping options • 73  
Solids  
    Solid toolbar • 25  
    Solid wizard • 19  
Standard toolbar • 18  
Status bar • 15, 50  
Steps • 31  
    Curves step • 34  
    Customize Manufacturing step • 39  
    Features step • 35  
    Geometry step • 33  
    NC Code step • 39  
    Steps panel • 15, 31  
    Steps toolbar • 25  
    Stock step • 32  
    Toolpaths step • 36  
Stock • 11  
    Stock step • 32  
Stop simulation • 22, 52  
Surfaces  
    Curves and Surfaces toolbar • 20  
    Surface from Curve menu • 19  
    Surface from Surface menu • 20  
    Surface from Surfaces menu • 20  
    Surface Primitives menu • 20  
    Surface wizard • 19

## T

Text • See Engraving  
Title bar • 15, 16  
Tool load • 22  
Toolbars • 15, 17  
    Curves and Surfaces toolbar • 20  
    Curve from Curve menu • 20  
    Curve from Surface menu • 20



- Curve menu • 20
- Surface from Curve menu • 19
- Surface from Surface menu • 20
- Surface from Surfaces menu • 20
- Surface Primitives menu • 20
- Display Mode toolbar • 21
- Geometry toolbar • 19, 22
  - Arc menu • 22
  - Chain menu • 22
  - Circle menu • 22
  - Dimension menu • 22
  - Edit menu • 22
  - Fillet menu • 22
  - Line menu • 22
  - Point • 22
- More Simulation toolbar • 25
- Simulation toolbar • 22
  - 3D rapidcut simulation • 22
  - 3D simulation • 22
  - Eject button • 22
  - Fast forward to end of simulation • 22
  - Machine simulation • 22
  - Pause simulation • 22
  - Play button • 22
  - Region of interest simulation • 22
  - Simulation speed • 22
  - Single step simulation • 22
  - Stop simulation • 22, 52
- Snap Mode toolbar • 20
- Solid toolbar • 25
- Standard toolbar • 18
- Steps toolbar • 25
- Toolbox • 15, 26
  - Part View panel • 15, 45
  - Steps panel • 15, 31
- Toolpaths step • 36
- Tools database • 42
- Transform • 18, 153
- Turn/mill • 97
- Turning • 82

## U

- UCS • 19
- Undo • 18, 52
- Units • 108
- Unshading • 21
  - Unshade all • 21
  - Unshade selected • 21
- Unshow normals • 21

## V

- View menu • 18
- Viewing • 29
  - Display Mode toolbar • 21
    - Hidden line mode • 21, 151
    - Shade Selected button • 21
    - Show normals • 21
    - Unshade all • 21
    - Unshade selected • 21
    - Unshow normals • 21
  - Graphics window • 15, 26
  - View menu • 18

## W

- Wizards
  - Curve wizard • 19
  - Solid wizard • 19
  - Surface wizard • 19